

# USER MANUAL

R203 / R203-P / R203-E / R203-U Series



SENECA S.r.l.

Via Austria 26 – 35127 – Z.I. - PADOVA (PD) - ITALY  
Tel. +39.049.8705355 – 8705355 Fax +39 049.8706287

[www.seneca.it](http://www.seneca.it)



ORIGINAL INSTRUCTIONS

The content of this documentation refers to products and technologies described in it.

All technical data contained in the document may be changed without notice.

The content of this documentation is subject to periodic review.

To use the product safely and effectively, read the following instructions carefully before use.

The product must be used only for the use for which it was designed and manufactured: any other use is under the full responsibility of the user.

Installation, programming and set-up are allowed only to authorized, physically and intellectually suitable operators.

Set-up must be performed only after correct installation and the user must follow all the operations described in the installation manual carefully.

Seneca is not responsible for failures, breakages and accidents caused by ignorance or failure to apply the stated requirements.

Seneca is not responsible for any unauthorized modifications.

Seneca reserves the right to modify the device, for any commercial or construction requirement, without the obligation to promptly update the reference manuals.

No liability for the contents of this document can be accepted.

Use the concepts, examples and other content at your own risk.

There may be errors and inaccuracies in this document that could damage your system, so proceed with caution, the author(s) will not take responsibility for it.

Technical specifications are subject to change without notice.

#### CONTACT US

Technical support	<a href="mailto:supporto@seneca.it">supporto@seneca.it</a>
Product information	<a href="mailto:commerciale@seneca.it">commerciale@seneca.it</a>

This document is the property of SENECA srl.  
Copies and reproduction are prohibited unless authorised

## Document revisions

DATE	REVISION	NOTES	AUTHOR
23/06/2023	0	First revision	MM
26/06/2023	1	Changed power supply value for R203-L version	AZ
02/10/2023	2	Added table of Rogowski sensor input full scale	AZ
03/11/2023	3	Added -P model Deleted models -1	MM
21/11/2023	4	Supported new firmwares: R203 rev 1030 R203-P rev 1024 For Aron insertion support	MM
01/12/2023	5	Added Dip Switch chapter	MM
05/12/2023	6	Fix Dip Switch name	AZ
07/12/2023	7	Added info on Datalogger and Smart Functions	MM
09/01/2023	8	Added new placeholders for Smart Functions from firmware 1035 %tms and %i	MM
19/02/2024	9	Fix Dip switch table in "Dip Switch" chapter	MM
22/03/2024	10	Added Modbus registers refresh time (Chapter 6.5)	MM
04/04/2024	11	Added new R203-E product	MM
15/05/2024	12	Added new R203-U product	MM
25/07/2024	13	-Fix Counter Frequency -Added Commands for Energy/Counters management -Added Counters for R203-P/-E	MM

**TABLE OF CONTENTS**

<b>1. WARNINGS .....</b>	<b>8</b>
<b>2. INTRODUCTION.....</b>	<b>9</b>
<b>3. R203 SERIES MODELS .....</b>	<b>9</b>
<b>4. DIP SWITCH .....</b>	<b>10</b>
<b>5. MEASUREMENTS AVAILABLE FROM ETHERNET/SERIAL.....</b>	<b>11</b>
<b>5.1. CONVENTIONS .....</b>	<b>11</b>
<b>5.2. INSTANTANEOUS VALUES .....</b>	<b>12</b>
<b>5.3. MEDIUM VALUES (IN THE CONFIGURED DEMAND TIME).....</b>	<b>12</b>
<b>5.4. ABSOLUTE MAXIMUM / MINIMUM VALUES.....</b>	<b>13</b>
<b>5.5. COUNTERS:.....</b>	<b>13</b>
<b>5.6. HARMONIC ANALYSIS UP TO THE 55<sup>TH</sup> (R203 MODEL ONLY).....</b>	<b>14</b>
<b>6. MEASUREMENT AND CALCULATION TIMES.....</b>	<b>15</b>
<b>6.1. SAMPLING TIMES .....</b>	<b>15</b>
<b>6.2. SETTLING TIMES FOR RMS VALUES.....</b>	<b>15</b>
<b>6.3. ANALOG OUTPUT RESPONSE TIME.....</b>	<b>15</b>
<b>6.4. UPDATE TIMES OF THE REGISTERS RELATING TO THE HARMONIC ANALYSIS (R203 MODELS ONLY).....</b>	<b>15</b>
<b>6.5. UPDATE TIMES OF THE MODBUS REGISTERS (R203 MODELS ONLY).....</b>	<b>15</b>
<b>7. MEASUREMENT PRECISION AT 23°C.....</b>	<b>16</b>

---

<b>8. ROGOWSKI SENSOR INPUT FULL SCALE .....</b>	<b>16</b>
<b>9. DATALOGGER (R203 MODELS ONLY).....</b>	<b>17</b>
<b>9.1. TIME DATA LOGGER .....</b>	<b>17</b>
<b>9.2. EVENT DATA LOGGER .....</b>	<b>17</b>
<b>10. SMART FUNCTIONS FOR SENDING DATA AND EVENTS TO THE CLOUDS (R203 MODELS ONLY) .....</b>	<b>18</b>
<b>10.1. MQTT(S) CLIENT PROTOCOL.....</b>	<b>18</b>
<b>10.2. HTTP(S) POST PROTOCOL.....</b>	<b>18</b>
<b>10.3. FTP CLIENT PROTOCOL.....</b>	<b>18</b>
<b>10.4. SENDING DATA AND EVENTS WITH OR WITHOUT RECOVERY .....</b>	<b>19</b>
<b>11. CONNECTION OF THE DEVICES TO A NETWORK .....</b>	<b>20</b>
<b>11.1. R203 / R203-E / R203-U MODELS .....</b>	<b>20</b>
<b>11.2. R203-P MODELS .....</b>	<b>21</b>
<b>12. I/O COPY USING THE PEER TO PEER FUNCTION WITHOUT WIRING (R203 MODELS ONLY) .....</b>	<b>21</b>
<b>13. WEB SERVER .....</b>	<b>23</b>
<b>13.1. ACCESS TO THE WEB SERVER.....</b>	<b>23</b>
<b>14. CONNECTION DIAGNOSTICS .....</b>	<b>24</b>
<b>15. DEVICE CONFIGURATION VIA WEBSERVER (R203 / R203-E / R203-U MODELS ONLY).....</b>	<b>25</b>
<b>15.1. COMMUNICATION SETUP SECTION.....</b>	<b>25</b>
<b>15.2. MEASURES SETUP SECTION.....</b>	<b>27</b>

<b>15.3.</b>	<b>ANALOG AND DIGITAL OUTPUT SETUP SECTION(R203 MODELS ONLY)...</b>	<b>28</b>
<b>15.4.</b>	<b>SETUP SECTION DIGITAL INPUT (R203 MODELS ONLY).....</b>	<b>29</b>
<b>15.5.</b>	<b>SETUP SECTION DATALOGGER (R203 MODELS ONLY) .....</b>	<b>29</b>
<b>15.6.</b>	<b>SETUP SECTION FTP (R203 MODELS ONLY).....</b>	<b>30</b>
<b>15.7.</b>	<b>CONNECTION DIAGNOSTIC SECTION .....</b>	<b>31</b>
<b>15.8.</b>	<b>MQTT CONFIGURATION SECTION (R203 MODELS ONLY) .....</b>	<b>31</b>
<b>15.8.1.</b>	<b>EXAMPLES: .....</b>	<b>41</b>
<b>15.9.</b>	<b>HTTP CONFIGURATION SECTION (R203 MODELS ONLY) .....</b>	<b>45</b>
<b>15.10.</b>	<b>OPC-UA CONFIGURATION SECTION (R203-U MODELS ONLY) .....</b>	<b>52</b>
<b>16.</b>	<b>DOWNLOADING THE DATALOGGER FILES (R203 MODELS ONLY).....</b>	<b>54</b>
<b>17.</b>	<b>MODBUS PASSTHROUGH (R203 MODELS ONLY) .....</b>	<b>54</b>
<b>18.</b>	<b>FIRMWARE UPDATE.....</b>	<b>55</b>
<b>19.</b>	<b>MODBUS COMMUNICATION PROTOCOL (R203 MODELS ONLY).....</b>	<b>55</b>
<b>19.1.</b>	<b>SUPPORTED MODBUS FUNCTION CODES .....</b>	<b>55</b>
<b>19.2.</b>	<b>MODBUS REGISTER TABLE.....</b>	<b>57</b>
<b>19.3.</b>	<b>NUMBERING OF "0-BASED" OR "1-BASED" MODBUS ADDRESSES .....</b>	<b>57</b>
<b>19.4.</b>	<b>NUMBERING OF MODBUS ADDRESSES WITH "0-BASED" CONVENTION...58</b>	
<b>19.5.</b>	<b>NUMBERING OF MODBUS ADDRESSES WITH "1 BASED" CONVENTION (STANDARD) .....</b>	<b>58</b>
<b>19.6.</b>	<b>BIT CONVENTION WITHIN A MODBUS HOLDING REGISTER .....</b>	<b>59</b>

<b>19.7. MSB AND LSB BYTE CONVENTION WITHIN A MODBUS HOLDING REGISTER</b>	
<b>59</b>	
<b>19.8. REPRESENTATION OF A 32-BIT VALUE IN TWO CONSECUTIVE MODBUS HOLDING REGISTERS.....</b>	<b>60</b>
<b>19.9. TYPE OF 32-BIT FLOATING POINT DATA (IEEE 754).....</b>	<b>60</b>
<b>19.10. MODBUS 4X HOLDING REGISTERS TABLE (FUNCTION CODE 3).....</b>	<b>62</b>
<b>20. PROFINET IO COMMUNICATION PROTOCOL (R203-P MODELS ONLY) .....</b>	<b>150</b>
<b>20.1. CREATING A PROJECT WITH SIEMENS PLC (TIA PORTAL 16) (R203-P MODELS ONLY) .....</b>	<b>150</b>
<b>20.1.1. INSTALLING THE GSDML FILE .....</b>	<b>151</b>
<b>20.1.2. INSERTION OF THE SIEMENS PLC IN THE PROJECT .....</b>	<b>152</b>
<b>20.1.3. INSERTION OF THE PROFINET SENECA IO .....</b>	<b>155</b>
<b>20.1.4. CONFIGURATION OF THE PARAMETERS OF THE SENECA DEVICE.....</b>	<b>159</b>
<b>20.1.5. CONFIGURATION PARAMETERS OF THE GSDML FILE .....</b>	<b>160</b>
<b>20.1.6. R203-P I/O DATA.....</b>	<b>161</b>
<b>21. ETHERNET/IP COMMUNICATION PROTOCOL (R203- E MODELS ONLY) .....</b>	<b>174</b>
<b>21.1. CREATING A PROJECT WITH PLC ALLEN BRADLEY/ROCKWELL (RS-LOGIX5000 / STUDIO 5000 LOGIX DESIGNER 35.00.00) .....</b>	<b>174</b>
<b>22. OPC-UA COMMUNICATION PROTOCOL (R203-U MODELS ONLY).....</b>	<b>183</b>
<b>22.1. CONFIGURATION OF THE UAEXPERT™ CLIENT FOR CONNECTION WITH R203-U</b>	<b>183</b>

## 1. WARNINGS

 **ATTENTION!**

This user manual extends the information from the installation manual to the configuration of the device. Use the installation manual for more information.

 **ATTENTION!**

In any case, SENECA s.r.l. or its suppliers will not be responsible for the loss of data/revenue or consequential or incidental damages due to negligence or bad/improper management of the device, even if SENECA is well aware of these possible damages.

**SENECA, its subsidiaries, affiliates, group companies, suppliers and distributors do not guarantee that the functions fully meet the customer's expectations or that the device, firmware and software should have no errors or operate continuously.**



## 2. INTRODUCTION

The three-phase smart energy meters of the R203 series allow the measurement and calculation of electrical quantities such as voltage, current, power, energy, harmonics, etc.

The devices are equipped with a universal current input (TA with current output, TA with voltage output, Rogowski sensors) and support single-phase and three-phase 3- or 4-wire insertion types.

Measurements and calculations are made available via communication protocols depending on the model.

In some models It is also possible to activate the data logger and send the data to the clouds via the MQTT(s), HTTP(s) or FTP protocols.

## 3. R203 SERIES MODELS

The R203 series models are shown in the table:

<b>MODEL</b>	<b>NUMBER OF ETHERNET PORTS</b>	<b>POWER SUPPLY</b>	<b>COMMUNICATION PROTOCOLS</b>	<b>DATALOGGER</b>	<b>SENDING DATA TO CLOUD (SMART FUNCTIONS)</b>
R203-2-L	2	10 ÷ 30Vdc	MODBUS TCP-IP MODBUS RTU MQTT(s) HTTP(s) FTP	YES	YES
R203-2-H	2	90 ÷ 264Vac	MODBUS TCP-IP MODBUS RTU MQTT(s) HTTP(s) FTP	YES	YES
R203-2-L-P	2	10 ÷ 30Vdc	PROFINET IO	NO	NO
R203-2-H-P	2	90 ÷ 264Vac	PROFINET IO	NO	NO
R203-2-L-E	2	10 ÷ 30Vdc	ETHERNET/IP	NO	NO
R203-2-H-E	2	90 ÷ 264Vac	ETHERNET/IP	NO	NO
R203-2-L-U	2	10 ÷ 30Vdc	OPC-UA SERVER	NO	NO
R203-2-H-U	2	90 ÷ 264Vac	OPC-UA SERVER	NO	NO

## 4. DIP SWITCH

The devices are fitted with 2 dip switches.  
The position of the dip switches is shown in the figure.



Below is the meaning of the SW1 dip switches:

<b>DIP1</b>	<b>DIP2</b>	<b>MEANING</b>
OFF	OFF	Normal operation: The device loads the configuration from the flash.
ON	ON	Resets the device to its factory configuration
OFF	ON	Disables access to the Web server
ON	OFF	Forces the device IP address to 192.168.90.101

## 5. MEASUREMENTS AVAILABLE FROM ETHERNET/SERIAL

### 5.1. CONVENTIONS

The device provides the measurement values on all 4 quadrants, the conventions for the signs of the measurements used in the product are summarized in the following image:

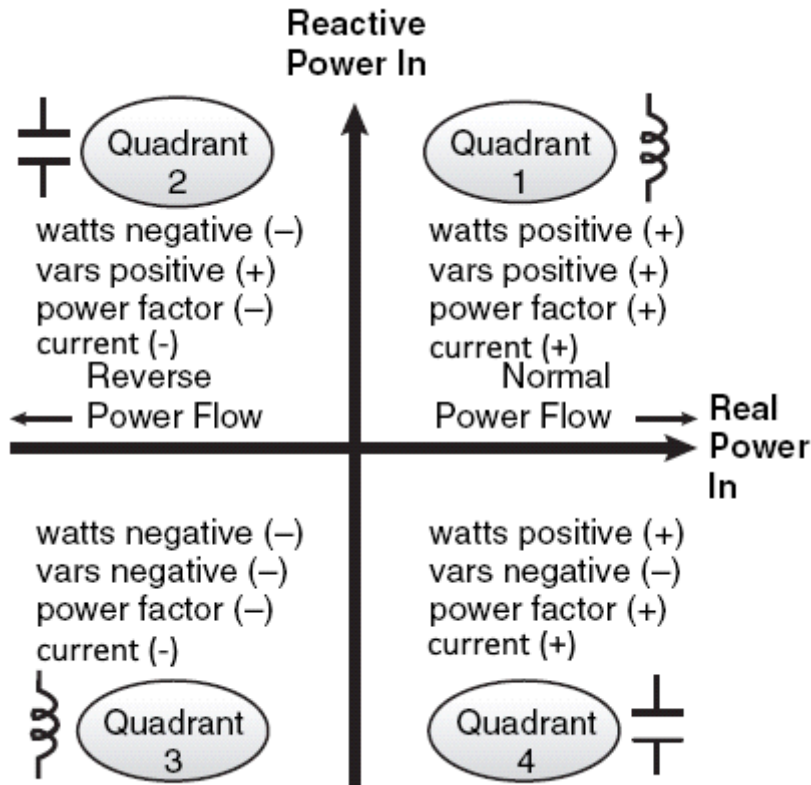

Where:

quadrant Q1 relates to an inductive load with imported (absorbed) active energy, classic use case.

quadrant Q2 relates to a capacitive load with exported (generated) active energy.

quadrant Q3 relates to an inductive load with exported (generated) active energy.

quadrant Q4 relates to a capacitive load with imported (absorbed) active energy.

5.2. INSTANTANEOUS VALUES

Voltage	VL1-L2, VL2-L3, VL3-L1, VL1-N, VL2-N, VL3-N
Current (+/-):	IL1, IL2, IL3, IN
Active power (+/-)	P1, P2, P3, Ptot
Reactive power (+/-)	Q1, Q2, Q3 and Qtot
Apparent power	S1, S2, S3 and Stot
Power factor (inductive and capacitive)	PF1, PF2, PF3 and PFtot
Frequency	F1, F2, F3
Period	PER1, PER2, PER3
Voltage-Current phase shift [°]	Delta VIL1, VIL2, VIL3
Line voltage phase shift [°]	Delta VL1-L2, VL2-L3, VL3-L1
Voltage total harmonic distortion (THD)	THD % VL1-N, VL2-N, VL3-N
Current total harmonic distortion (THD)	THD % IL1, IL2, IL3
System voltage:	$V_{sys} = (VL1+VL2+VL3)/3$
System current	$I_{sys} = (IL1+IL2+IL3)/3$
Status of the digital input/output	-
Input 1 and 2 counter	Count1, Count2

5.3. MEDIUM VALUES (IN THE CONFIGURED DEMAND TIME)

Medium voltage	VL1-N, VL2-N, VL3-N, VL1-N MINIMUM, VL1-N MAXIMUM, VL2-N MINIMUM, VL2-N MAXIMUM, VL3-N MINIMUM, VL3-N MAXIMUM
Medium current (+/-)	IL1, IL2, IL3, IL1 MINIMUM, IL1 MAXIMUM, IL2 MINIMUM, IL2 MAXIMUM, IL3 MINIMUM, IL3 MAXIMUM
Medium active power (+/-)	P1, P2, P3, P1 MINIMUM, P1 MAXIMUM, P2 MINIMUM, P2 MAXIMUM, P3 MINIMUM, P3 MAXIMUM, Ptot
Medium reactive power (+/-)	Q1, Q2, Q3, Q1 MINIMUM, Q1 MAXIMUM, Q2 MINIMUM, Q2 MAXIMUM, Q3 MINIMUM, Q3 MAXIMUM, Qtot
Medium apparent power	S1, S2, S3, S1 MINIMUM, S1 MAXIMUM, S2 MINIMUM, S2 MAXIMUM, S3 MINIMUM, S3 MAXIMUM, Stot
Medium power factor (inductive and capacitive)	PF1, PF2, PF3, PF1 MINIMUM, PF1 MAXIMUM, PF2 MINIMUM, PF2 MAXIMUM, PF3 MINIMUM, PF3 MAXIMUM, PFtot
Average system voltage	VSYS, VSYS MINIMUM, VSYS MAXIMUM
Average system current	ISYS, ISYS MINIMUM, ISYS MAXIMUM

5.4. ABSOLUTE MAXIMUM / MINIMUM VALUES

Voltage	VL1-N MINIMUM, VL1-N MAXIMUM, VL2-N MINIMUM, VL2-N MAXIMUM, VL3-N MINIMUM, VL3-N MAXIMUM
Current (+/-):	IL1 MINIMUM, IL1 MAXIMUM, IL2 MINIMUM, IL2 MAXIMUM, IL3 MINIMUM, IL3 MAXIMUM
Active power (+/-)	P1 MINIMUM, P1 MAXIMUM, P2 MINIMUM, P2 MAXIMUM, P3 MINIMUM, P3 MAXIMUM, Ptot
Reactive power (+/-)	Q1 MINIMUM, Q1 MAXIMUM, Q2 MINIMUM, Q2 MAXIMUM, Q3 MINIMUM, Q3 MAXIMUM, Qtot
Apparent power	S1 MINIMUM, S1 MAXIMUM, S2 MINIMUM, S2 MAXIMUM, S3 MINIMUM, S3 MAXIMUM, Stot
Power factor (inductive and capacitive)	PF1 MINIMUM, PF1 MAXIMUM, PF2 MINIMUM, PF2 MAXIMUM, PF3 MINIMUM, PF3 MAXIMUM, PFtot
Average system voltage	VSYS, VSYS MINIMUM, VSYS MAXIMUM
Average system current	ISYS, ISYS MINIMUM, ISYS MAXIMUM

5.5. COUNTERS:

All counters are stored in non-volatile memory.

ACTIVE ENERGY [Wh]	ACTIVE ENERGY L1 (+) Q1/Q4 ACTIVE ENERGY L2 (+) Q1/Q4 ACTIVE ENERGY L3 (+) Q1/Q4 ACTIVE ENERGY L1 (-) Q2/Q3 ACTIVE ENERGY L2 (-) Q2/Q3 ACTIVE ENERGY L3 (-) Q2/Q3 TOT ACTIVE ENERGY (+) Q1/Q4 TOT ACTIVE ENERGY (-) Q2/Q3 TOTAL ACTIVE ENERGY BALANCE (+/-)
REACTIVE ENERGY [VARh]	REACTIVE ENERGY L1 (+) Q1/Q2 REACTIVE ENERGY L2 (+) Q1/Q2 REACTIVE ENERGY L3 (+) Q1/Q2  REACTIVE ENERGY L1 (-) Q3/Q4 REACTIVE ENERGY L2 (-) Q3/Q4 REACTIVE ENERGY L3 (-) Q3/Q4  REACTIVE ENERGY L1 (+) Q1 REACTIVE ENERGY L2 (+) Q1

	<p>REACTIVE ENERGY L3 (+) Q1</p> <p>REACTIVE ENERGY L1 (+) Q2 REACTIVE ENERGY L2 (+) Q2 REACTIVE ENERGY L3 (+) Q2</p> <p>REACTIVE ENERGY L1 (-) Q3 REACTIVE ENERGY L2 (-) Q3 REACTIVE ENERGY L3 (-) Q3</p> <p>REACTIVE ENERGY L1 (-) Q4 REACTIVE ENERGY L2 (-) Q4 REACTIVE ENERGY L3 (-) Q4</p> <p>TOT REACTIVE ENERGY (+) Q1/Q2 TOT REACTIVE ENERGY (-) Q3/Q4 TOTAL REACTIVE ENERGY BALANCE (+-)</p>
APPARENT ENERGY [VAh]	<p>APPARENT ENERGY L1 APPARENT ENERGY L2 APPARENT ENERGY L3 TOTAL APPARENT ENERGY</p>
DIGITAL COUNTER INPUT 1 AND INPUT 2	<p>32 BIT COUNTERS MAXIMUM FREQUENCY 50 Hz</p>

**5.6. HARMONIC ANALYSIS UP TO THE 55<sup>TH</sup> (R203 MODEL ONLY)**

VOLTAGE HARMONICS FROM THE FUNDAMENTAL TO THE 55 <sup>TH</sup> [V]	VL1-N, VL2-N, VL3-N
CURRENT HARMONICS FROM THE FUNDAMENTAL TO THE 55 <sup>TH</sup> [A]	IL1, IL2, IL3
VOLTAGE HARMONICS FROM THE 2 <sup>ND</sup> TO THE 55 <sup>TH</sup> [% IN COMPARISON WITH THE FUNDAMENTAL]	VL1-N, VL2-N, VL3-N
CURRENT HARMONICS FROM THE 2 <sup>ND</sup> TO THE 55 <sup>TH</sup> [% IN COMPARISON WITH THE FUNDAMENTAL]	IL1, IL2, IL3

## **6. MEASUREMENT AND CALCULATION TIMES**

### **6.1. SAMPLING TIMES**

The sampling time of the current channels is 8000 samples per second.

The sampling time of the voltage channels is 8000 samples per second

### **6.2. SETTLING TIMES FOR RMS VALUES**

We define the settling time as the time required for the RMS value to reach 99.5% of the full scale in response to an input from 0% to 100% of the Full scale.

For RMS currents the settling time is 580 ms for TA input with current or voltage output

For RMS currents the settling time is 700 ms for Rogowski input

For RMS voltages the settling time is 580 ms.

### **6.3. ANALOG OUTPUT RESPONSE TIME**

Analog Output Response Time: Typical 10 ms (10-90%)

### **6.4. UPDATE TIMES OF THE REGISTERS RELATING TO THE HARMONIC ANALYSIS (R203 MODELS ONLY)**

The individual registers relating to the individual harmonics are updated every 30 seconds.

### **6.5. UPDATE TIMES OF THE MODBUS REGISTERS (R203 MODELS ONLY)**

The measurement update time in Modbus registers is shown in the following table:

<b><i>Modbus Registers</i></b>	<b><i>Typical Modbus Refresh time for Phase L1, L2 and L3 [ms]</i></b>
Voltage phase to phase L1, L2, L3	200
Current L1, L2, L3, N	25
Active Power L1, L2, L3	25

## 7. MEASUREMENT PRECISION AT 23°C

Type of measurement	Precision at 23°C
Current (TA current output)	0.2% of the measurement with 1000:1 dynamic range
Current (TA voltage output)	0.2% of the measurement with 1000:1 dynamic range
Current (Rogowski)	0.5% of the measurement with 1000:1 dynamic range
Voltage	0.2% of the measurement with 1000:1 dynamic range
Active power (current measurement with current or voltage TA)	0.5% of the measurement with PF=1 and 2000:1 dynamic range
Reactive power (current measurement with TA)	0.5% of the measurement with PF=0 and 2000:1 dynamic range
Active power (current measurement with Rogowski)	0.5% of the measurement with PF=1 and 500:1 dynamic range
Reactive power (current measurement with Rogowski)	0.5% of the measurement with PF=0 and 500:1 dynamic range

## 8. ROGOWSKI SENSOR INPUT FULL SCALE

INPUT	F.S. 50 Hz (FORM FACTOR 2) [A]	F.S. 60 Hz (FORM FACTOR 2) [A]
ROGOWSKI 1000A/333mV (750A@50Hz)	750	600
ROGOWSKI 1000A/100mV (1250A@50Hz)	1250	1000
ROGOWSKI 1000A/83mV (750A@50Hz)	750	600
ROGOWSKI 1000A/25mV (1250A@50Hz)	1250	1000
ROGOWSKI 1000A/100 mV (2500A@50Hz)	2500	2000
ROGOWSKI 1000A/100 mV (625A@50Hz)	625	500
ROGOWSKI 1000A/100 mV (312A@50Hz)	312	250



## 9. **DATALOGGER (R203 MODELS ONLY)**

The device has two different data loggers (that can be enabled also simultaneously):

- a configurable sampling time data logger with a maximum speed of 1 sample per second;
- an event data logger, that is, it records the configured event (just one) and the date/time when it occurred;

It is possible to download the data of both data loggers to a device via web server, the format is text separated by commas (csv standard).

### 9.1. **TIME DATA LOGGER**

The time data logger allows you to store a maximum of 30 variables (tags) in the device's internal flash for a maximum number of 65504 samples each with a maximum of 30 variables.

The sampling time can vary between 1 second (minimum) to 24 h (maximum).

It is also possible to start e stop the data logger through the status of a digital input.

Example of the contents of the time data logger csv file:

```
DATE/TIME;V31_MIN;V2N_AVG_MIN;V2N_AVG_MAX;V3N;V23_AVG_MAX;V3N_MIN;V3N_MAX;V31_AVG_MAX;Vsys;Vsys_AVG;Vsys_MIN;Vsys_MAX;Vsys_AVG_MIN;
2023-12-07-14-52-06;0.000;0.002;0.119;0.085;0.058;0.081;0.089;0.058;0.316;0.058;0.000;0.316;0.000;
2023-12-07-14-52-36;0.000;0.002;0.119;0.084;0.069;0.081;0.090;0.069;0.316;0.069;0.000;0.316;0.000;
2023-12-07-14-53-19;0.000;0.002;0.117;0.086;0.005;0.081;0.089;0.005;0.316;0.005;0.000;0.316;0.000;
2023-12-07-14-53-49;0.000;0.002;0.117;0.085;0.016;0.081;0.089;0.016;0.316;0.016;0.000;0.316;0.000;
2023-12-07-14-54-19;0.000;0.002;0.117;0.085;0.026;0.081;0.089;0.026;0.316;0.026;0.000;0.316;0.000;
2023-12-07-14-54-49;0.000;0.002;0.117;0.087;0.037;0.081;0.090;0.037;0.316;0.037;0.000;0.316;0.000;
2023-12-07-14-55-19;0.000;0.002;0.117;0.085;0.047;0.081;0.090;0.047;0.316;0.047;0.000;0.316;0.000;
2023-12-07-14-55-49;0.000;0.002;0.117;0.086;0.058;0.081;0.090;0.058;0.316;0.058;0.000;0.316;0.000;
2023-12-07-14-56-20;0.000;0.002;0.117;0.085;0.069;0.081;0.090;0.069;0.316;0.069;0.000;0.316;0.000;
2023-12-07-14-56-50;0.000;0.002;0.117;0.086;0.079;0.081;0.090;0.079;0.316;0.079;0.000;0.316;0.000;
2023-12-07-14-57-20;0.000;0.002;0.117;0.086;0.090;0.081;0.090;0.090;0.316;0.090;0.000;0.316;0.000;
2023-12-07-14-57-50;0.000;0.002;0.117;0.085;0.100;0.080;0.090;0.100;0.316;0.100;0.000;0.316;0.000;
2023-12-07-14-58-20;0.000;0.002;0.117;0.085;0.111;0.080;0.090;0.111;0.316;0.111;0.000;0.316;0.000;
2023-12-07-14-58-50;0.000;0.002;0.117;0.082;0.121;0.080;0.090;0.121;0.316;0.121;0.000;0.316;0.000;
2023-12-07-14-59-20;0.000;0.002;0.117;0.083;0.132;0.080;0.090;0.132;0.316;0.132;0.000;0.316;0.000;
2023-12-07-14-59-50;0.000;0.002;0.117;0.083;0.142;0.080;0.090;0.142;0.316;0.142;0.000;0.316;0.000;
```

### 9.2. **EVENT DATA LOGGER**

If you need to record the date/time of a particular event, you can use the event data logger.

This can record a maximum of 4096 samples of a single event with their time tags.

It is possible to define just one event by indicating the variable to be monitored and its threshold (or alarm window).

Example of the contents of the event data logger csv file:

```
DATE/TIME;EVENT TYPE;
2023-12-07-15-24-42;ALARM;
2023-12-07-15-24-45;ALARM RETURN;
2023-12-07-15-24-47;ALARM;
2023-12-07-15-24-49;ALARM RETURN;
```

## 10. SMART FUNCTIONS FOR SENDING DATA AND EVENTS TO THE CLOUDS (R203 MODELS ONLY)

The values acquired by dataloggers can be sent directly to the clouds by choosing between the MQTT(s), Http(s) or FTP protocols.

You can choose to send with a single protocol between Mqtt(s), http(s) or FTP.

### 10.1. MQTT(s) CLIENT PROTOCOL

MQTT is the most widely used protocol for IOT applications.

*"MQTT" stands for MQ Telemetry Transport. It is an extremely simple and lightweight public/subscription messaging protocol designed for devices with low bandwidth, high latency or unreliable networks. The design principles are to minimize network bandwidth and device resource requirements while trying to ensure reliability and a certain degree of delivery guarantee. These principles prove ideal for the emerging machine-to-machine (M2M) or Internet of Things world.*

For more information on the MQTT protocol see



The MQTT version supported is 3.1.1

Sending via MQTT can be parameterized using a simple syntax, it is also possible to add the timestamp (in date/time minutes seconds or in seconds since 1/1/1970 "epoch" format).

Using Mqtt it is also possible to insert a threshold beyond which data can be sent or not.

### 10.2. HTTP(s) POST PROTOCOL

Communication with the Clouds is possible via HTTP protocol with a POST call.

The data sent to the server is contained in the body of the HTTP request.

Sending via HTTP can be parameterized using a simple syntax, it is also possible to add the timestamp (in date/time minutes seconds or in seconds since 1/1/1970 "epoch" format).

### 10.3. FTP CLIENT PROTOCOL

Data can also be sent to an FTP server.

In this case the logs are sent directly in the csv format produced by the data logger

#### 10.4. *SENDING DATA AND EVENTS WITH OR WITHOUT RECOVERY*

If you set a log sampling time over or equal to 30 seconds, you can activate the recovery function.

In this mode data and events are sent with the configured sending time but, in the event of a communication hole, anything that has not been sent will be sent at the next connection.

## 11. CONNECTION OF THE DEVICES TO A NETWORK

### 11.1. R203 / R203-E / R203-U MODELS

The factory configuration of the IP address is:

**Static address: 192.168.90.101**

Therefore, multiple devices must not be inserted on the same network with the same static IP.

If you want to connect multiple devices on the same network, you need to change the IP address configuration (for instance using the Seneca Discovery Device software).



**DO NOT CONNECT 2 OR MORE FACTORY-CONFIGURED DEVICES ON THE SAME NETWORK, OR THE  
ETHERNET INTERFACE WILL NOT WORK  
(CONFLICT OF IP ADDRESSES 192.168.90.101)**

If the addressing mode with DHCP is activated and an IP address is not received within 1 minute, the device will set an IP address with a fixed error:

169.254.x.y

Where x.y are the last two values of the MAC ADDRESS.

This way it is possible to install more I/O of the R series and then configure the IP Address even on networks without a DHCP server.

## 11.2. R203-P MODELS

Profinet IO devices are supplied without an IP address.

### **ATTENTION!**

THE R203-P DEVICES WITH PROFINET IO PROTOCOL ARE SUPPLIED WITHOUT AN IP ADDRESS (0.0.0.0).

MORE DEVICES CAN THEREFORE BE INSERTED INTO THE SAME PROFINET NETWORK AND IDENTIFIED THROUGH SCAN OF THE PROFINET NETWORK ITSELF

TO SET AN IP ADDRESS (FOR EXAMPLE TO ACCESS THE WEBSERVER) USE THE PROFINET CONFIGURATION ENVIRONMENT OR FORCE THE ADDRESS 192.168.90.101 WITH THE APPROPRIATE DIP SWITCH

## 12. I/O COPY USING THE PEER TO PEER FUNCTION WITHOUT WIRING (R203 MODELS ONLY)

The "R" series devices can be used to copy and update in real time an input channel on a remote output channel without the aid of a master controller.

For example, a digital input can be copied to a remote digital output device:



Note that no controller is required because the communication is managed directly by the R series devices.

It is possible to make a more sophisticated connection, for example it is possible to copy the inputs to different R-series remote devices (from Device 1 Input 1 to Device 2 Output1, Device 1 Input 2 to Device 3 Output 1 etc ...)

It is also possible to copy an input to an output of multiple remote devices:

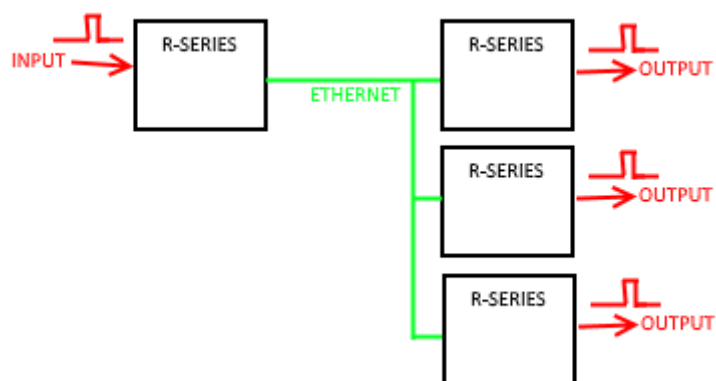

Each R-series device can send and receive a maximum of 32 inputs.

## 13. WEB SERVER

### 13.1. ACCESS TO THE WEB SERVER

Access to the web server takes place using a web browser and entering the IP address of the device. To find out the IP address of the device, use the "search" function of the "Easy Setup 2" software or of the "Seneca Discovery Device" software.

Using the factory configuration (pay attention to the model purchased, for example for the -P models it is necessary to force the IP from the dip switch) you have:

<http://192.168.90.101>

On first access the user name and password will be requested.

The default values are:

User Name: admin

Password: admin

 **ATTENTION!**

**AFTER THE FIRST ACCESS CHANGE USER NAME AND PASSWORD IN ORDER TO PREVENT ACCESS TO THE DEVICE TO UNAUTHORIZED PEOPLE.**

 **ATTENTION!**

**IF THE PARAMETERS TO ACCESS THE WEB SERVER HAVE BEEN LOST, IT IS NECESSARY TO RESET THE CONFIGURATION TO DEFAULT USING THE DIP-SWITCHES**

 **ATTENTION!**

**IN R203-P DEVICES, BEFORE ACCESSING THE WEB SERVER, DISCONNECT THE DEVICE FROM THE IO PROFINET NETWORK**

## 14. CONNECTION DIAGNOSTICS

The device includes advanced connection diagnostics available on the webserver and on communication protocols.

If the system detects a connection error, the WIRING ERROR LED will flash, at this point it is possible to check the reason for the error:

**VOLTAGE CYCLIC DIRECTION** If it is "Wrong" it indicates that the connection of the voltmeters does not comply with the cyclic direction R (L1) -> S (L2) -> T (L3). To solve the problem, wire the voltage inputs again.

If it is "Correct" go to the next item. This is not a real connection error (and therefore does not cause the WIRING ERROR LED to flash).

**CURRENT L1..L3** If it is "STRAIGHT" it indicates that the TA relating to the i-th input is connected correctly. If it is "INVERTED" it indicates that the TA relating to the i-th input is reversed (reverse the wiring of the TA terminals). When the three currents are "STRAIGHT" it is possible to move on to the next item.



### **ATTENTION!**

**IF THE DEVICE IS CONNECTED TO A GENERATOR, IT IS CORRECT THAT CURRENT L1..L3 ARE ALL "INVERTED".**

**IN THIS CASE, THE WORD "PRODUCTION" WILL APPEAR IN THE "ENERGY" FIELD .**

**L1..L3 CONNECTION** If this parameter is "CORRECT" it means that the L-i th current input and the L-i th voltage input have been wired correctly.

In the case of "ERROR" it means that, for example the Li-th phase of the current does not coincide with the Li-th voltage phase, therefore a wiring error of the ammeters or voltmeters (for example the current L1 has been connected to the current input L2).

It is, in fact, possible to wire complying with the cyclic direction of the voltages and the correct direction of the TAs but have no correspondence between the voltage and current phases.

In this case, wire the device again (for example, it is possible to move the voltmeters by 1 position, always complying with the cyclic direction until this error disappears).

In the case of non-standard installation configurations, a parameter can be configured to ignore the diagnostics.



## 15. **DEVICE CONFIGURATION VIA WEBSERVER (R203 / R203-E / R203-U MODELS ONLY)**

To configure the device, access the web server and select the section you are interested in.

After a modification to the configuration has been made, the changes must be confirmed with the "**APPLY**" button entering the administrator account and password.

The **Reboot** button reboots the device (not necessary in the event of a configuration change).

The **Default** button returns all the page parameters to the default settings.

### 15.1. **COMMUNICATION SETUP SECTION**

#### **DHCP (ETH) (default: Disabled)**

Sets the DHCP client to get an IP address automatically.

#### **IP ADDRESS STATIC (ETH) (default: 192.168.90.101)**

Sets the device static address. Careful not to enter devices with the same IP address into the same network.

#### **IP MASK STATIC (ETH) (default: 255.255.255.0)**

Sets the mask for the IP network.

#### **GATEWAY ADDRESS STATIC (ETH) (default: 192.168.90.1)**

Sets the gateway address.

#### **DNS (default: 8.8.8.8)**

Set the Domain Name System.

#### **PROTECT CONFIGURATION (default: Disabled)**

Allows you to enable or disable password protection for reading and writing the configuration (including the IP address) using the Easy Setup 2 software or Seneca Discovery Tool. The password is the same one that allows accessing the web server.

### **ATTENTION!**

**IF THE CONFIGURATION PROTECTION IS ENABLED IT WILL BE IMPOSSIBLE TO READ/WRITE THE CONFIGURATION OF THE DEVICE WITHOUT KNOWING THE ADMINISTRATOR PASSWORD.  
IF THE PASSWORD IS LOST, IT WILL BE POSSIBLE TO RETURN THE DEVICE TO DEFAULT USING THE DIP SWITCHES**

#### **MODBUS SERVER PORT (ETH) (R203 models only) (default: 502)**

Sets the communication port for the Modbus TCP-IP server.

#### **MODBUS SERVER STATION ADDRESS (ETH) (R203 models only)(default: 1)**

Active only if Modbus Passthrough is also active, it sets the station address of the modbus TCP-IP server.

**⚠ ATTENTION!**

THE MODBUS SERVER WILL ANSWER ANY STATION ADDRESS ONLY IF THE MODBUS PASSTHROUGH MODE IS DISABLED.

**MODBUS PASSTHROUGH (ETH) (R203 models only)(default: disabled)**

Sets the conversion mode from Modbus TCP-IP to Modbus RTU serial (see chapter 14).

**MODBUS TCP-IP CONNECTION TIMEOUT [sec] (ETH) (R203 models only) (default: 60)**

Sets the TCP-IP connection timeout for the Modbus TCP-IP server and Passthrough modes.

**P2P SERVER PORT (R203 models only) (default: 50026)**

Sets the communication port for the P2P server.

**WEBSERVER ACCOUNT NAME (default: admin)**

Sets the user name to access the web server.

**USER ACCOUNT CONFIGURATION/WEBSERVER PASSWORD (default: admin)**

Sets the password to access the webserver and to read/write the configuration (if enabled).

**WEB SERVER PORT (default: 80)**

Sets the communication port for the web server.

**BAUDRATE MODBUS RTU (SER) (R203 models only) (default: 38400 baud)**

Sets the baud rate for the RS485 communication port.

**DATA MODBUS RTU (SER) (R203 models only) (default: 8 bit)**

Sets the number of bits for the RS485 communication port.

**PARITY MODBUS RTU (SER) (R203 models only) (default: None)**

Sets the parity for the RS485 communication port.

**STOP BIT MODBUS RTU (SER) (R203 models only) (default: 1 bit)**

Sets the number of stop bits for the RS485 communication port.

**MODBUS PASSTHROUGH SERIAL TIMEOUT ( (R203 models only) (default: 100ms)**

Active only if passthrough mode is activated, sets the maximum waiting time before sending a new packet from TCP-IP to the serial port. It must be set according to the longest response time of all the devices present on the RS485 serial port.

## 15.2. **MEASURES SETUP SECTION**

### **CONNECTION TYPE**

Sets the type of connection to make.

### **CT TYPE**

Selects the type of sensor and the value of the TA secondary to be used between:

TA with current output

TA with MV output

Rogowski sensor

### **CT RATIO**

Sets any TA ratio, the value to enter is related to the primary, example:

If a 50/5 TA has been installed, the value 50 must be entered as primary with the value 5 on the "TA TYPE" parameter.

### **VT TYPE**

Sets the type of voltage transformer

### **NETWORK FREQUENCY [Hz]**

Sets the system to 50 or 60 Hz.

### **AVERAGE POWER WINDOW**

Sets the time on which to measure the average values

### **USER CALIBRATION VOLTAGE**

Sets a possible multiplication coefficient for the voltage measurement.

### **USER CALIBRATION CURRENT**

Sets a possible multiplication coefficient for the current measurement.

### **CUTOFF CURRENT [A]**

Sets a current value (on the primary) below which counters are stopped.

### **USER CALIBRATION ACTIVE ENERGY**

Sets a possible multiplication coefficient for the active energy.

### **USER CALIBRATION REACTIVE ENERGY**

Sets a possible multiplication coefficient for the reactive energy.

### **ANALOG OUTPUT TYPE**

Selects the type of analog output between voltage and current

**15.3. ANALOG AND DIGITAL OUTPUT SETUP SECTION (R203 MODELS ONLY)*****ANALOG OUTPUT RETRANSMITTED PHASE***

Selects which phase is brought to the analog output (selectable between L1, L2, L3)

***ANALOG OUTPUT RETRANSMITTED VALUE***

Selects which variable is brought to the analog output (selectable between voltage RMS, current RMS, active power, power factor, reactive factor, apparent power, frequency)

***DIGITAL OUTPUT LOGIC***

Selects the output logic (normally high or low).

***DIGITAL OUTPUT FUNCTION***

Selects the type of function the digital output must perform

***DIGITAL OUTPUT SOURCE***

Selects the variable to take to the analog output

#### 15.4. **SETUP SECTION DIGITAL INPUT (R203 MODELS ONLY)**

##### **DIGITAL INPUT 1 MODE**

Selects the behaviour of digital input 1 if input or start/stop for the data logger.

In the "start/stop data logger" mode, when the digital input goes high the data logger starts recording (start), when the digital input goes low the data logger stops (stop).

##### **DIGITAL INPUT 2 MODE**

Selects the behaviour of digital input 2 if input or start/stop for the data logger.

In the "start/stop data logger" mode, when the digital input goes high the data logger starts recording (start), when the digital input goes low the data logger stops (stop).

##### **DIGITAL INPUT FILTER [ms]**

Sets the filter time for digital inputs, used as filtering for counters.

#### 15.5. **SETUP SECTION DATALOGGER (R203 MODELS ONLY)**

##### **EVENT MODE**

Selects the maximum, minimum or window alarm event.

##### **RETURN EVENT**

Enables or not also the alarm exit event

##### **EVENT SOURCE**

Selects the variable to use for the alarm event

##### **EVENT HIGH THRESHOLD**

Sets the threshold representing the high alarm event.

##### **EVENT LOW THRESHOLD**

Sets the threshold representing the low alarm event.

##### **HYSTERESIS**

Represents the event hysteresis

##### **DATA LOGGER SAMPLE TIME**

Enables/Disables and sets the sampling time for the timed data logger.

##### **DATA RECOVERY**

If the sample time is  $\geq 30$ s it is possible to choose whether the sending of data must take place with or without recovery in case of momentary lack of communication.

##### **DATA LOGGER CONNECTOR**

Allows you to choose whether to send data via MQTT, HTTP or FTP protocols.

##### **DATA LOGGER SOURCE 1...30**

Selects the i-th variable to be entered in the timed data logger.

## 15.6. **SETUP SECTION FTP (R203 MODELS ONLY)**

In this section the timed sending of logs to an FTP server can be configured. The sending of the logs takes place without encryption.

By pressing the “**FTP SEND NOW**” button a log file is forced to be sent, it will be possible to test the operation of the data entered.

### **FTP DATA LOGGER SENDING**

Here you can select the frequency of the log sending, in the case of weekly sending you can also choose which days and at what time to send.

### **FTP SERVER**

Sets the IP address or FTP server name.

### **FTP SERVER PORT**

Sets the server FTP port

### **FTP USER NAME**

Sets the user name to access the server FTP

### **FTP PASSWORD**

Sets the password to access the server FTP

### **FTP FOLDER**

Sets the folder to write logs to (leave blank for root)

### **FTP DEVICE NAME**

Sets the name you want to give to the R203, this will be the initial part of the file name on the server.

## **ATTENTION!**

**IN THE EVENT OF LACK OF CONNECTION WITH THE FTP SERVER, THE DEVICE WILL CONTINUE TO RECORD THE LOGS AS LONG AS THERE IS SPACE IN THE MEMORY. WHEN THE CONNECTION RESUMES, IT WILL SEND THE LOGS NOT YET SENT IN A SINGLE FILE.**

## **ATTENTION!**

**THE FORMAT OF THE FILES SENT IS THE SAME AS THAT OBTAINED BY DOWNLOADING THE TIME DATABASE FROM THE WEB SERVER (CSV FORMAT).**

### **15.7. CONNECTION DIAGNOSTIC SECTION**

In this section you can check if the connection to the device has been made correctly.

It is also possible to exchange the CURRENT - VOLTAGE relationship of each phase without rewiring the system.

In the case of particular connections, the CONNECTION DIAGNOSTIC parameter can be configured to "DISABLE" so that the system ignores connection errors.

### **15.8. MQTT CONFIGURATION SECTION (R203 MODELS ONLY)**

#### **MAX FAILURE COUNTER**

Maximum number of errors before waiting the time of the "WAIT AFTER FAILURE" parameter

#### **WAIT AFTER FAILURE (minutes)**

Waiting time before trying a new CONNECTION

#### **CLIENT ID**

Defines the Client ID used in the MQTT protocol

#### **BROKER HOST**

Defines the host name of the MQTT broker

#### **BROKER PORT**

Defines the MQTT broker port

#### **USE WEBSOCKETS**

Allows you to activate MQTT communication via Websockets

#### **KEEP ALIVE INTERVAL (seconds)**

This parameter defines Keep alive which ensures that the connection between the broker and client is still open and that the broker and client are aware that they are connected. When the client establishes a connection to the broker, it tells the broker a time interval in seconds. This interval defines the maximum period of time during which the broker and client may not communicate with each other.

#### **CLEAN SESSION**

This parameter defines the "clean session".

When the clean session flag is set to true, the client does not want a persistent session. If the client disconnects for any reason, all information and messages queued from a previous session are lost.

#### **MESSAGE RETAIN**

Usually if a publisher publishes a message on a topic to which no one is subscribed, the message is simply discarded by the broker. However, the publisher can tell the broker to keep the last message of that topic.

#### **QUALITY OF SERVICE**

This parameter defines the QOS of the MQTT protocol.

Can be selected from

QOS 0 (once only, without ack)

QOS 1 (at least once, with ack)

QOS 2 (once only, with ack and resend)

### ***AUTHENTICATION***

This parameter defines whether user/password authentication should be used to access the broker

### ***USERNAME***

Broker Username

### ***PASSWORD***

Broker password

### ***SSL/TLS***

Defines whether to enable the SSL/TLS 1.2 encrypted security protocol

### ***CLIENT CERTIFICATE REQUIRED***

Defines whether to manage certificates for the SSL/TLS connection

### ***CHECK CERTIFICATES***

Checks the certificates are valid

### ***LOG ON CHANGE***

Updates values on broker only upon change and no longer over time

### ***HYSTERESIS***

Hysteresis value for analog data (one hysteresis for all configured variables) to be sent with the “Log on change” function

### ***PUBLISH WITH MULTIPLE TAGS***

This parameter defines whether the publish contains multiple tags or whether the device should send a publish for each tag



### **PUBLISH TOPIC FOR LOGS**

Select the topic name for the logs using the following table:

%c	Device Client ID
%m	Device MAC Address
%j[field]	Adds double quotes " to [field]. The double quotes represent a string in JSON

for example:

If:

Device Client ID = Padova13

Publish Topic for Logs = seneca/%c/data

The data logs will be sent to the topic: Seneca/Padova13/data

### **PUBLISH PAYLOAD FOR LOGS**

Selects the format to be used for the payload using the following table:

%c	Device Client ID
%m	Device MAC Address
%d	date-time
%t	timestamp (number of seconds from 01/01/1970)
%tms	timestamp (number of milliseconds from 01/01/1970)
%b	bulk (format specified in "Publish Bulk Format")
%n	Tag name (only for "Publish Bulk Format")
%i	Unique ID of the variable
%v	Tag value (only in "Publish Bulk Format")
%j[field]	Adds double quotes " to [field]. The double quotes represent a string in JSON

**Note:** the %i placeholder adds a unique ID to the variable to be published according to the following table:

%i (ID)	VARIABLE
1	V1N
2	V1N_AVG
3	V1N_MIN

4	V1N_MAX
5	V1N_AVG_MIN
6	V1N_AVG_MAX
7	V2N
8	V2N_AVG
9	V2N_MIN
10	V2N_MAX
11	V2N_AVG_MIN
12	V2N_AVG_MAX
13	V3N
14	V3N_AVG
15	V3N_MIN
16	V3N_MAX
17	V3N_AVG_MIN
18	V3N_AVG_MAX
19	AN
20	AN_AVG
21	AN_MIN
22	AN_MAX
23	AN_AVG_MIN
24	AN_AVG_MAX
25	V12
26	V12_AVG
27	V12_MIN
28	V12_MAX
29	V12_AVG_MIN
30	V12_AVG_MAX
31	V23
32	V23_AVG
33	V23_MIN
34	V23_MAX
35	V23_AVG_MIN
36	V23_AVG_MAX
37	V31
38	V31_AVG
39	V31_MIN
40	V31_MAX
41	V31_AVG_MIN
42	V31_AVG_MAX
43	Vsys
44	Vsys_AVG
45	Vsys_MIN
46	Vsys_MAX

47	Vsys_AVG_MIN
48	Vsys_AVG_MAX
49	A1
50	A1_AVG
51	A1_MIN
52	A1_MAX
53	A1_AVG_MIN
54	A1_AVG_MAX
55	A2
56	A2_AVG
57	A2_MIN
58	A2_MAX
59	A2_AVG_MIN
60	A2_AVG_MAX
61	A3
62	A3_AVG
63	A3_MIN
64	A3_MAX
65	A3_AVG_MIN
66	A3_AVG_MAX
67	Asys
68	Asys_AVG
69	Asys_MIN
70	Asys_MAX
71	Asys_AVG_MIN
72	Asys_AVG_MAX
73	P1
74	P1_AVG
75	P1_MIN
76	P1_MAX
77	P1_AVG_MIN
78	P1_AVG_MAX
79	P2
80	P2_AVG
81	P2_MIN
82	P2_MAX
83	P2_AVG_MIN
84	P2_AVG_MAX
85	P3
86	P3_AVG
87	P3_MIN
88	P3_MAX
89	P3_AVG_MIN

90	P3_AVG_MAX
91	Psys
92	Psys_AVG
93	Psys_MIN
94	Psys_MAX
95	Psys_AVG_MIN
96	Psys_AVG_MAX
97	S1
98	S1_AVG
99	S1_MIN
100	S1_MAX
101	S1_AVG_MIN
102	S1_AVG_MAX
103	S2
104	S2_AVG
105	S2_MIN
106	S2_MAX
107	S2_AVG_MIN
108	S2_AVG_MAX
109	S3
110	S3_AVG
111	S3_MIN
112	S3_MAX
113	S3_AVG_MIN
114	S3_AVG_MAX
115	Ssys
116	Ssys_AVG
117	Ssys_MIN
118	Ssys_MAX
119	Ssys_AVG_MIN
120	Ssys_AVG_MAX
121	Q1
122	Q1_AVG
123	Q1_MIN
124	Q1_MAX
125	Q1_AVG_MIN
126	Q1_AVG_MAX
127	Q2
128	Q2_AVG
129	Q2_MIN
130	Q2_MAX
131	Q2_AVG_MIN
132	Q2_AVG_MAX

133	Q3
134	Q3_AVG
135	Q3_MIN
136	Q3_MAX
137	Q3_AVG_MIN
138	Q3_AVG_MAX
139	Qsys
140	Qsys_AVG
141	Qsys_MIN
142	Qsys_MAX
143	Qsys_AVG_MIN
144	Qsys_AVG_MAX
145	TPF1
146	TPF1_AVG
147	TPF1_MIN
148	TPF1_MAX
149	TPF1_AVG_MIN
150	TPF1_AVG_MAX
151	TPF2
152	TPF2_AVG
153	TPF2_MIN
154	TPF2_MAX
155	TPF2_AVG_MIN
156	TPF2_AVG_MAX
157	TPF3
158	TPF3_AVG
159	TPF3_MIN
160	TPF3_MAX
161	TPF3_AVG_MIN
162	TPF3_AVG_MAX
163	TPFsys
164	TPFsys_AVG
165	TPFsys_MIN
166	TPFsys_MAX
167	TPFsys_AVG_MIN
168	TPFsys_AVG_MAX
169	THD-V1N
170	THD-V1N_AVG
171	THD-V1N_MIN
172	THD-V1N_MAX
173	THD-V1N_AVG_MIN
174	THD-V1N_AVG_MAX
175	THD-V2N

176	THD-V2N_AVG
177	THD-V2N_MIN
178	THD-V2N_MAX
179	THD-V2N_AVG_MIN
180	THD-V2N_AVG_MAX
181	THD-V3N
182	THD-V3N_AVG
183	THD-V3N_MIN
184	THD-V3N_MAX
185	THD-V3N_AVG_MIN
186	THD-V3N_AVG_MAX
187	f
188	THD-A1N
189	THD-A1N_AVG
190	THD-A1N_MIN
191	THD-A1N_MAX
192	THD-A1N_AVG_MIN
193	THD-A1N_AVG_MAX
194	THD-A2N
195	THD-A2N_AVG
196	THD-A2N_MIN
197	THD-A2N_MAX
198	THD-A2N_AVG_MIN
199	THD-A2N_AVG_MAX
200	THD-A3N
201	THD-A3N_AVG
202	THD-A3N_MIN
203	THD-A3N_MAX
204	THD-A3N_AVG_MIN
205	THD-A3N_AVG_MAX
206	+WH1
207	+WH2
208	+WH3
209	+Wh
210	-WH1
211	-WH2
212	-WH3
213	-Wh
214	VAh1
215	VAh2
216	VAh3
217	VAh
218	+VARh1-L[Q1]

219	+VARh2-L[Q1]
220	+VARh3-L[Q1]
221	+VARh-L[Q1]
222	-VARh1-C[Q4]
223	-VARh2-C[Q4]
224	-VARh3-C[Q4]
225	-VARh-C[Q4]
226	-VARh1-L[Q3]
227	-VARh2-L[Q3]
228	-VARh3-L[Q3]
229	-VARh-L[Q3]
230	+VARh1-C[Q2]
231	+VARh2-C[Q2]
232	+VARh3-C[Q2]
233	+VARh-C[Q2]
234	Wh
235	VARh
236	VARh-L[Q1Q3]
237	VARh-C[Q2Q4]
238	VAh
239	COUNTER 1
240	COUNTER 2
241	DIGITAL_IN_1
242	DIGITAL_IN_2
243	DIGITAL_OUT_1
244	DIGITAL_OUT_2

### **PUBLISH BULK FORMAT**

Select the format for "bulk mode" according to the following table:

%c	Device Client ID
%m	Device MAC Address
%d	Date/Time
%t	timestamp (number of seconds from 01/01/1970)
%n	Tag name (only for "Publish Bulk Format")
%v	Tag value (only in "Publish Bulk Format")
%j[field]	Adds double quotes " to [field]. The double quotes represent a string in JSON

### **PUBLISH TOPIC FOR EVENT**

Selects the format for topic names in events according to the following table:

%c	Device Client ID
%m	Device MAC Address
%j[field]	Adds double quotes " to [field]. The double quotes represent a string in JSON

### ***PUBLISH PAYLOAD FOR EVENT***

Selects the format to be used for the payload using the following table:

%c	Device Client ID
%m	Device MAC Address
%d	date-time
%t	timestamp (number of seconds from 01/01/1970)
%x	text of the event
%j[field]	Adds double quotes " to [field]. The double quotes represent a string in JSON

### ***MQTT STATUS***

Indicates the status of the MQTT communication with the date/time of the last successful communication.

### ***CA CERTIFICATE FILE (.crt)***

File that represents the Root CA Certificate

### ***CLIENT CERTIFICATE FILE (.crt)***

File that represents the Client Certificate

### ***CLIENT KEY FILE (.key)***

File that represents the Client key



### 15.8.1. *Examples:*

With the following configuration:

CLIENT ID = R203 MQTT Client

PUBLISH TOPIC FOR LOGS = seneca/%c/data

PUBLISH PAYLOAD FOR LOGS = {"t":%jt,"v":[%b]}

PUBLISH BULK FORMAT = {"n":%jn,"v":%jv}

You will get in the topic

seneca/R203 MQTT Client/data

the following content:

```
{"t":"1687536452","v":[{"n":"V1N","v":"0.088"},{"n":"V1N_AVG","v":"0.006"},{"n":"V1N_MIN","v":"0.079"},{"n":"V1N_MAX","v":"0.096"},{"n":"V1N_AVG_MIN","v":"0.001"},{"n":"V1N_AVG_MAX","v":"0.089"},{"n":"V2N","v":"0.087"},{"n":"V31_MIN","v":"0.000"},{"n":"V2N_AVG_MIN","v":"0.002"},{"n":"V2N_AVG_MAX","v":"0.090"},{"n":"V3N","v":"0.081"},{"n":"V23_AVG_MAX","v":"0.016"},{"n":"V3N_MIN","v":"0.074"},{"n":"V3N_MAX","v":"0.090"},{"n":"V31_AVG_MAX","v":"0.016"},{"n":"Vsys","v":"0.316"},{"n":"Vsys_AVG","v":"0.016"},{"n":"Vsys_MIN","v":"0.000"},{"n":"Vsys_MAX","v":"0.316"},{"n":"Vsys_AVG_MIN","v":"0.000"}]}
```

With the following configuration:

MAX FAILURE COUNTER	3	<input type="text" value="3"/>
WAIT AFTER FAILURE (minutes)	30	<input type="text" value="30"/>
CLIENT ID	R203 MQTT Client	<input type="text" value="R203 MQTT Client"/>
BROKER HOST	test.mosquitto.org	<input type="text" value="test.mosquitto.org"/>
BROKER PORT	1883	<input type="text" value="1883"/>
USE WEBSOCKETS	OFF	<input type="text" value="OFF"/>
KEEP ALIVE INTERVAL (seconds)	30	<input type="text" value="30"/>
CLEAN SESSION	OFF	<input type="text" value="OFF"/>
MESSAGE RETAIN	OFF	<input type="text" value="OFF"/>
QUALITY OF SERVICE	QoS 0	<input type="text" value="QoS 0"/>
AUTHENTICATION	OFF	<input type="text" value="OFF"/>
USERNAME	admin	<input type="text" value="admin"/>
PASSWORD	admin	<input type="text" value="admin"/>
SSL/TLS	OFF	<input type="text" value="OFF"/>
CLIENT CERTIFICATE REQUIRED	OFF	<input type="text" value="OFF"/>
CHECK CERTIFICATES	OFF	<input type="text" value="OFF"/>
LOG ON CHANGE	OFF	<input type="text" value="OFF"/>
PUBLISH WITH MULTIPLE TAGS	OFF	<input type="text" value="OFF"/>
PUBLISH TOPIC FOR LOGS	seneca/%c/data	<input type="text" value="seneca/%c/data"/>
PUBLISH PAYLOAD FOR LOGS	{"t":%jt,"v":[%b]}	<input t\":%jt,\"v\":[%b]}"="" type="text" value="{\"/>
PUBLISH BULK FORMAT	{"n":%jn,"v":%jv}	<input n\":%jn,\"v\":%jv}"="" type="text" value="{\"/>
PUBLISH TOPIC FOR EVENT	seneca/%c/event	<input type="text" value="seneca/%c/event"/>
PUBLISH PAYLOAD FOR EVENT	{%x}	<input type="text" value="{%x}"/>
MQTT STATUS	 07/12/2023 16:36:02	
<input type="button" value="REBOOT"/>	<input type="button" value="FACTORY DEFAULT"/>	<input type="button" value="APPLY"/>

For example, you will get:

```
1 - {
2   "t": "1701966872",
3   "v": [
4     {
5       "n": "V31_MIN",
6       "v": "0.000"
7     },
8     {
9       "n": "V2N_AVG_MIN",
10      "v": "0.581"
11    },
12    {
13      "n": "V2N_AVG_MAX",
14      "v": "34.850"
15    },
16    {
17      "n": "V3N",
18      "v": "35.052"
19    },
20    {
21      "n": "V23_AVG_MAX",
22      "v": "0.037"
23    },
24    {
25      "n": "V3N_MIN",
26      "v": "34.611"
27    },
28    {
29      "n": "V3N_MAX",
30      "v": "35.092"
31    },
32    {
33      "n": "V31_AVG_MAX",
34      "v": "0.352"
35    },
36    {
37      "n": "Vsys",
38      "v": "2.145"
39    },
40    {
41      "n": "Vsys_AVG",
42      "v": "0.250"
43    },
44    {
```

With the following configuration:

	CURRENT	UPDATED
<b>NOTE:</b> Log Publish Period is given by "DATA LOGGER SAMPLE TIME" parameter (see page "Setup Datalogger").		
MAX FAILURE COUNTER	3	<input type="text" value="3"/>
WAIT AFTER FAILURE (minutes)	30	<input type="text" value="30"/>
CLIENT ID	R203 MQTT Client	<input type="text" value="R203 MQTT Client"/>
BROKER HOST	test.mosquitto.org	<input type="text" value="test.mosquitto.org"/>
BROKER PORT	1883	<input type="text" value="1883"/>
USE WEBSOCKETS	OFF	<input type="text" value="OFF"/>
KEEP ALIVE INTERVAL (seconds)	30	<input type="text" value="30"/>
CLEAN SESSION	OFF	<input type="text" value="OFF"/>
MESSAGE RETAIN	OFF	<input type="text" value="OFF"/>
QUALITY OF SERVICE	QoS 0	<input type="text" value="QoS 0"/>
AUTHENTICATION	OFF	<input type="text" value="OFF"/>
USERNAME	admin	<input type="text" value="admin"/>
PASSWORD	admin	<input type="text" value="admin"/>
SSL/TLS	OFF	<input type="text" value="OFF"/>
CLIENT CERTIFICATE REQUIRED	OFF	<input type="text" value="OFF"/>
CHECK CERTIFICATES	OFF	<input type="text" value="OFF"/>
LOG ON CHANGE	OFF	<input type="text" value="OFF"/>
PUBLISH WITH MULTIPLE TAGS	ON	<input type="text" value="ON"/>
PUBLISH TOPIC FOR LOGS	seneca/%c/data	<input type="text" value="seneca/%c/data"/>
PUBLISH PAYLOAD FOR LOGS	{"n":%jn,"v":%jv}	<input n\":%jn,\"v\":%jv}"="" type="text" value="{\"/>
PUBLISH BULK FORMAT	{"n":%jn,"v":%jv}	<input n\":%jn,\"v\":%jv}"="" type="text" value="{\"/>
PUBLISH TOPIC FOR EVENT	seneca/%c/event	<input type="text" value="seneca/%c/event"/>
PUBLISH PAYLOAD FOR EVENT	{%x}	<input type="text" value="{%x}"/>
MQTT STATUS	<span style="color: green;">●</span> 07/12/2023 16:38:16	
<input type="button" value="REBOOT"/>	<input type="button" value="FACTORY DEFAULT"/>	<input type="button" value="APPLY"/>

Note the "PUBLISH PAYLOAD FOR LOGS" parameter, it will send a whole series of packets of the type:

```
1 - {  
2   "n": "Vsys_AVG_MIN",  
3   "v": "0.000"  
4 }
```

## 15.9. **HTTP CONFIGURATION SECTION (R203 MODELS ONLY)**

### **MAX FAILURE COUNTER**

Maximum number of errors before waiting the time of the "WAIT AFTER FAILURE" parameter

### **WAIT AFTER FAILURE (minutes)**

Waiting time before trying a new CONNECTION

### **SSL/TLS**

Defines whether to enable the SSL/TLS 1.2 encrypted security protocol

### **HOST**

Defines the host name of the server

### **PORT**

Defines the http server port

### **AUTHENTICATION**

This parameter defines whether user/password authentication should be used to access the http server

### **USERNAME**

HTTP server username

### **PASSWORD**

HTTP server password

### **LOG ON CHANGE**

Updates values on the server only on change

### **HYSTERESIS**

Hysteresis value for the analogue data to be sent with the "Log on change" function

### **PUBLISH WITH MULTIPLE TAGS**

This parameter defines whether the post contains multiple tags or whether the device should send a post for each tag

### **PUBLISH PAYLOAD FOR LOGS**

Selects the format to be used for the payload using the following table:

%m	Device MAC Address
%t	timestamp (number of seconds from 01/01/1970)
%tms	timestamp (number of milliseconds from 01/01/1970)
%b	bulk (format specified in "Publish Bulk Format")
%i	Unique ID of the variable (only for "Publish Bulk Format")
%n	Tag name (only for "Publish Bulk Format")
%v	Tag value (only in "Publish Bulk Format")
%j[field]	Adds double quotes " to [field]. The double quotes represent a string in JSON

### **PUBLISH BULK FORMAT**

Select the format for "bulk mode" according to the following table:

%c	Device Client ID
%m	Device MAC Address
%d	Date/Time
%t	timestamp (number of seconds from 01/01/1970)
%tms	timestamp (number of milliseconds from 01/01/1970)
%i	Unique ID of the variable (only for "Publish Bulk Format")
%n	Tag name (only for "Publish Bulk Format")
%v	Tag value (only in "Publish Bulk Format")
%j[field]	Adds double quotes " to [field]. The double quotes represent a string in JSON

**Note:** the %i placeholder adds a unique ID to the variable to be published according to the following table:

%i (ID)	VARIABLE
1	V1N
2	V1N_AVG
3	V1N_MIN
4	V1N_MAX
5	V1N_AVG_MIN
6	V1N_AVG_MAX
7	V2N
8	V2N_AVG

9	V2N_MIN
10	V2N_MAX
11	V2N_AVG_MIN
12	V2N_AVG_MAX
13	V3N
14	V3N_AVG
15	V3N_MIN
16	V3N_MAX
17	V3N_AVG_MIN
18	V3N_AVG_MAX
19	AN
20	AN_AVG
21	AN_MIN
22	AN_MAX
23	AN_AVG_MIN
24	AN_AVG_MAX
25	V12
26	V12_AVG
27	V12_MIN
28	V12_MAX
29	V12_AVG_MIN
30	V12_AVG_MAX
31	V23
32	V23_AVG
33	V23_MIN
34	V23_MAX
35	V23_AVG_MIN
36	V23_AVG_MAX
37	V31
38	V31_AVG
39	V31_MIN
40	V31_MAX
41	V31_AVG_MIN
42	V31_AVG_MAX
43	Vsys
44	Vsys_AVG
45	Vsys_MIN
46	Vsys_MAX
47	Vsys_AVG_MIN
48	Vsys_AVG_MAX
49	A1
50	A1_AVG
51	A1_MIN

52	A1_MAX
53	A1_AVG_MIN
54	A1_AVG_MAX
55	A2
56	A2_AVG
57	A2_MIN
58	A2_MAX
59	A2_AVG_MIN
60	A2_AVG_MAX
61	A3
62	A3_AVG
63	A3_MIN
64	A3_MAX
65	A3_AVG_MIN
66	A3_AVG_MAX
67	Asys
68	Asys_AVG
69	Asys_MIN
70	Asys_MAX
71	Asys_AVG_MIN
72	Asys_AVG_MAX
73	P1
74	P1_AVG
75	P1_MIN
76	P1_MAX
77	P1_AVG_MIN
78	P1_AVG_MAX
79	P2
80	P2_AVG
81	P2_MIN
82	P2_MAX
83	P2_AVG_MIN
84	P2_AVG_MAX
85	P3
86	P3_AVG
87	P3_MIN
88	P3_MAX
89	P3_AVG_MIN
90	P3_AVG_MAX
91	Psys
92	Psys_AVG
93	Psys_MIN
94	Psys_MAX



95	Psys_AVG_MIN
96	Psys_AVG_MAX
97	S1
98	S1_AVG
99	S1_MIN
100	S1_MAX
101	S1_AVG_MIN
102	S1_AVG_MAX
103	S2
104	S2_AVG
105	S2_MIN
106	S2_MAX
107	S2_AVG_MIN
108	S2_AVG_MAX
109	S3
110	S3_AVG
111	S3_MIN
112	S3_MAX
113	S3_AVG_MIN
114	S3_AVG_MAX
115	Ssys
116	Ssys_AVG
117	Ssys_MIN
118	Ssys_MAX
119	Ssys_AVG_MIN
120	Ssys_AVG_MAX
121	Q1
122	Q1_AVG
123	Q1_MIN
124	Q1_MAX
125	Q1_AVG_MIN
126	Q1_AVG_MAX
127	Q2
128	Q2_AVG
129	Q2_MIN
130	Q2_MAX
131	Q2_AVG_MIN
132	Q2_AVG_MAX
133	Q3
134	Q3_AVG
135	Q3_MIN
136	Q3_MAX
137	Q3_AVG_MIN

138	Q3_AVG_MAX
139	Qsys
140	Qsys_AVG
141	Qsys_MIN
142	Qsys_MAX
143	Qsys_AVG_MIN
144	Qsys_AVG_MAX
145	TPF1
146	TPF1_AVG
147	TPF1_MIN
148	TPF1_MAX
149	TPF1_AVG_MIN
150	TPF1_AVG_MAX
151	TPF2
152	TPF2_AVG
153	TPF2_MIN
154	TPF2_MAX
155	TPF2_AVG_MIN
156	TPF2_AVG_MAX
157	TPF3
158	TPF3_AVG
159	TPF3_MIN
160	TPF3_MAX
161	TPF3_AVG_MIN
162	TPF3_AVG_MAX
163	TPFsys
164	TPFsys_AVG
165	TPFsys_MIN
166	TPFsys_MAX
167	TPFsys_AVG_MIN
168	TPFsys_AVG_MAX
169	THD-V1N
170	THD-V1N_AVG
171	THD-V1N_MIN
172	THD-V1N_MAX
173	THD-V1N_AVG_MIN
174	THD-V1N_AVG_MAX
175	THD-V2N
176	THD-V2N_AVG
177	THD-V2N_MIN
178	THD-V2N_MAX
179	THD-V2N_AVG_MIN
180	THD-V2N_AVG_MAX

181	THD-V3N
182	THD-V3N_AVG
183	THD-V3N_MIN
184	THD-V3N_MAX
185	THD-V3N_AVG_MIN
186	THD-V3N_AVG_MAX
187	f
188	THD-A1N
189	THD-A1N_AVG
190	THD-A1N_MIN
191	THD-A1N_MAX
192	THD-A1N_AVG_MIN
193	THD-A1N_AVG_MAX
194	THD-A2N
195	THD-A2N_AVG
196	THD-A2N_MIN
197	THD-A2N_MAX
198	THD-A2N_AVG_MIN
199	THD-A2N_AVG_MAX
200	THD-A3N
201	THD-A3N_AVG
202	THD-A3N_MIN
203	THD-A3N_MAX
204	THD-A3N_AVG_MIN
205	THD-A3N_AVG_MAX
206	+WH1
207	+WH2
208	+WH3
209	+Wh
210	-WH1
211	-WH2
212	-WH3
213	-Wh
214	VAh1
215	VAh2
216	VAh3
217	VAh
218	+VARh1-L[Q1]
219	+VARh2-L[Q1]
220	+VARh3-L[Q1]
221	+VARh-L[Q1]
222	-VARh1-C[Q4]
223	-VARh2-C[Q4]

224	-VARh3-C[Q4]
225	-VARh-C[Q4]
226	-VARh1-L[Q3]
227	-VARh2-L[Q3]
228	-VARh3-L[Q3]
229	-VARh-L[Q3]
230	+VARh1-C[Q2]
231	+VARh2-C[Q2]
232	+VARh3-C[Q2]
233	+VARh-C[Q2]
234	Wh
235	VARh
236	VARh-L[Q1Q3]
237	VARh-C[Q2Q4]
238	VAh
239	COUNTER 1
240	COUNTER 2
241	DIGITAL_IN_1
242	DIGITAL_IN_2
243	DIGITAL_OUT_1
244	DIGITAL_OUT_2

## PUBLISH PAYLOAD FOR EVENT

Selects the format to be used for the payload using the following table:

%c	Device Client ID
%m	Device MAC Address
%d	date-time
%t	timestamp (number of seconds from 01/01/1970)
%x	text of the event
%j[field]	Adds double quotes " to [field]. The double quotes represent a string in JSON

## HTTP STATUS

Indicates the status of the HTTP communication with the date/time of the last successful communication.

## 15.10. OPC-UA CONFIGURATION SECTION (R203-U MODELS ONLY)

**MAX FAILURE COUNTER**

Maximum number of errors before waiting the time of the "WAIT AFTER FAILURE" parameter

**SERVER NAME**

Name that identifies the R203 server

**SERVER PORT**

R203 server port

**AUTHENTICATION**

Establishes whether or not to activate authentication with username and password

**USERNAME**

Username to be used if authentication is active

**PASSWORD**

Password be used if authentication is active

**OPC-UA SERVER SECURITY POLICY**

Set the server security policy, you can choose between:

- BASIC128RSA15
- BASIC256
- BASIC256SHA256
- AES128SHA256RSAOAEF

**OPC-UA SERVER MESSAGE SECURITY MODE**

Select between:

- NONE
- SIGN
- SIGN AND ENCRYPT

**OPC-UA VARIABLE LIST**

Select the variables to publish on the OPC-UA server, a maximum of 60 variables can be published

**OPC-UA SERVER CERTIFICATE**

File that represents the Server Certificate in DER format

**OPC-UA SERVER KEY**

File that represents the Server key

**RESET CERTIFICATE**

Reload the default certificate and key

**16. DOWNLOADING THE DATALOGGER FILES (R203 MODELS ONLY)**

In the "Data logger view" section you can download the entire timed database in csv text format.  
In the "Data logger event view" section you can download the entire event database in csv text format.



## ATTENTION!

**THE TEXT FILES DOWNLOADED BY THE DATA LOGGER HAVE THE DEFAULT .CGI EXTENSION. TO USE THEM WITH EXCEL-TYPE SOFTWARE IT IS POSSIBLE TO RENAME THEM AS .CSV**

**17. MODBUS PASSTHROUGH (R203 MODELS ONLY)**

Thanks to the Modbus Passthrough function it is possible to extend the amount of I/O available in the device via the RS485 port and the Modbus RTU slave protocol, for example by using the Seneca Z-PC series products. In this mode the RS485 port stops working as Modbus RTU slave and the device becomes a Modbus TCP-IP gateway to Modbus RTU serial:

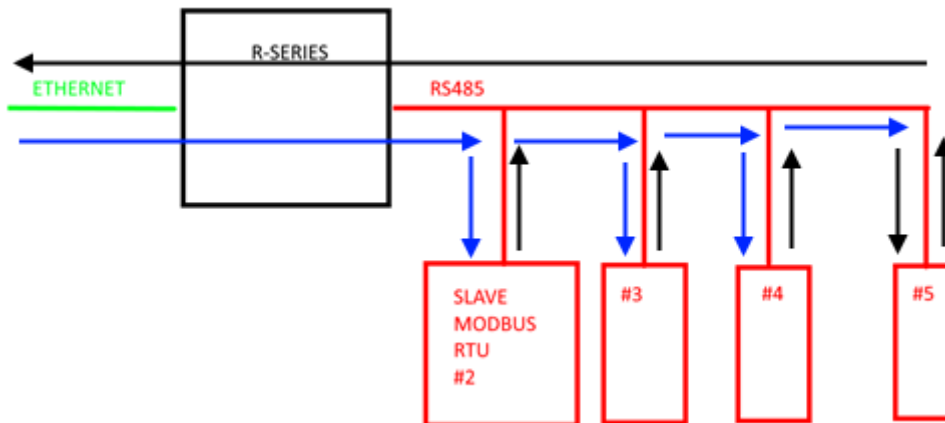

Each Modbus TCP-IP request with station address other than that of the R series device is converted into a serial packet on the RS485 and, in the case of a reply, it is turned over to TCP-IP. Therefore, it is no longer necessary to purchase gateways to extend the I/O number or to connect already available Modbus RTU I/O.

## 18. **FIRMWARE UPDATE**

In the “Update” section of the Webserver it is possible to update the firmware using a binary file that can be downloaded directly from the Seneca website in the download section of the device.

### **ATTENTION!**

**BEFORE UPDATING THE FW, STOP COMMUNICATION WITH THE PLC CONNECTED TO THE DEVICE (FOR EXAMPLE BY DISCONNECTING THE ETHERNET CABLE) OTHERWISE THE COMMUNICATION WITH THE PLC WILL PREVENT THE CORRECT SENDING OF THE FIRMWARE AND THE PROCEDURE WILL NOT BE SUCCESSFUL.**

## 19. **MODBUS COMMUNICATION PROTOCOL (R203 MODELS ONLY)**

The supported communication protocol is:

- Modbus RTU Slave (from the RS485 port)
- Modbus TCP-IP Server (from Ethernet ports)

The Modbus TCP-IP Server supports up to 8 concurrent clients.

For more information on these protocols, see the website:

<http://www.modbus.org/specs.php>.

### 19.1. **SUPPORTED MODBUS FUNCTION CODES**

The following Modbus functions are supported:

- Read Holding Register (function 3)
- Write Single Register (function 6)
- Write Multiple registers (function 16)

### **ATTENTION!**

**All 32-bit values are contained in 2 consecutive registers**

### **ATTENTION!**

**All 64-bit values are contained in 4 consecutive registers**

**ATTENTION!**

Any registers with RW\* (in flash memory) can be written up to about 10000 times  
The PLC/Master Modbus programmer must not exceed this limit



## 19.2. MODBUS REGISTER TABLE

The following abbreviations are used in the register tables:

MS = More significant
LS = Less significant
MSW = Most significant word (16bit)
LSW = Least significant word (16bit)
MMSW = Most "most" significant word (16bit)
LLSW = Least "least" significant word (16bit)
MSW = 8 most significant bits
LSB = 8 least significant bits
MSBIT = Most significant bit
MSBIT = Least significant bit
RO = Register in read-only
RW = Read/write register
RW** = Reading and writing register contained in flash memory, writable a maximum of 10000 times.
Unsigned 16 bit = unsigned integer register, can take values from 0 to 65535
Signed 16 bit = signed integer register can take values from -32768 to +32767
Float 32 bits = 32-bit single-precision floating point register (IEEE 754) <a href="https://en.wikipedia.org/wiki/IEEE_754">https://en.wikipedia.org/wiki/IEEE_754</a>
BIT = Boolean registry, can be 0 (false) or 1 (true)

## 19.3. NUMBERING OF "0-BASED" OR "1-BASED" MODBUS ADDRESSES

According to the Modbus standard the Holding Register registers are addressable from 0 to 65535, there are 2 different conventions for numbering the addresses: "0-BASED" and "1-BASED".

For greater clarity, Seneca shows its register tables in both conventions.

### **ATTENTION!**

**CAREFULLY READ THE DOCUMENTATION OF THE MODBUS MASTER DEVICE IN ORDER TO UNDERSTAND WHICH OF THE TWO CONVENTIONS THE MANUFACTURER HAS DECIDED TO USE**

#### 19.4. NUMBERING OF MODBUS ADDRESSES WITH "0-BASED" CONVENTION

The numbering is:

<b>HOLDING REGISTER MODBUS ADDRESS (OFFSET)</b>	<b>MEANING</b>
0	FIRST REGISTER
1	SECOND REGISTER
2	THIRD REGISTER
3	FOURTH REGISTER
4	FIFTH REGISTER

Therefore, the first register is at address 0.

In the following tables, this convention is indicated with "**ADDRESS OFFSET**".

#### 19.5. NUMBERING OF MODBUS ADDRESSES WITH "1 BASED" CONVENTION (STANDARD)

The numbering is that established by the Modbus consortium and is of the type:

<b>HOLDING REGISTER MODBUS ADDRESS 4x</b>	<b>MEANING</b>
40001	FIRST REGISTER
40002	SECOND REGISTER
40003	THIRD REGISTER
40004	FOURTH REGISTER
40005	FIFTH REGISTER

In the following tables this convention is indicated with "**ADDRESS 4x**" since a 4 is added to the address so that the first Modbus register is 40001.

A further convention is also possible where the number 4 is omitted in front of the register address:

<b>HOLDING MODBUS ADDRESS WITHOUT 4x</b>	<b>MEANING</b>
1	FIRST REGISTER
2	SECOND REGISTER
3	THIRD REGISTER
4	FOURTH REGISTER
5	FIFTH REGISTER

### 19.6. BIT CONVENTION WITHIN A MODBUS HOLDING REGISTER

A Modbus Holding Register consists of 16 bits with the following convention:

BIT 15	BIT 14	BIT 13	BIT 12	BIT 11	BIT 10	BIT 9	BIT 8	BIT 7	BIT 6	BIT 5	BIT 4	BIT 3	BIT 2	BIT 1	BIT 0
-----------	-----------	-----------	-----------	-----------	-----------	----------	----------	----------	----------	----------	----------	----------	----------	----------	----------

For instance, if the value of the register in decimal is  
12300

the value 12300 in hexadecimal is:

0x300C

the hexadecimal 0x300C in binary value is:

11 0000 0000 1100

So, using the above convention, we get:

BIT 15	BIT 14	BIT 13	BIT 12	BIT 11	BIT 10	BIT 9	BIT 8	BIT 7	BIT 6	BIT 5	BIT 4	BIT 3	BIT 2	BIT 1	BIT 0
0	0	1	1	0	0	0	0	0	0	0	0	1	1	0	0

### 19.7. MSB and LSB BYTE CONVENTION WITHIN A MODBUS HOLDING REGISTER

A Modbus Holding Register consists of 16 bits with the following convention:

BIT 15	BIT 14	BIT 13	BIT 12	BIT 11	BIT 10	BIT 9	BIT 8	BIT 7	BIT 6	BIT 5	BIT 4	BIT 3	BIT 2	BIT 1	BIT 0
-----------	-----------	-----------	-----------	-----------	-----------	----------	----------	----------	----------	----------	----------	----------	----------	----------	----------

LSB Byte (Least Significant Byte) defines the 8 bits ranging from Bit 0 to Bit 7 included, we define MSB Byte (Most Significant Byte) the 8 bits ranging from Bit 8 to Bit 15 inclusive:

BIT 15	BIT 14	BIT 13	BIT 12	BIT 11	BIT 10	BIT 9	BIT 8	BIT 7	BIT 6	BIT 5	BIT 4	BIT 3	BIT 2	BIT 1	BIT 0
BYTE MSB								BYTE LSB							



Using the last representation the value 2.54 is represented at 32 bits as:

0x40228F5C

Since we have 16-bit registers available, the value must be divided into MSW and LSW:

0x4022 (16418 decimal) are the 16 most significant bits (MSW) while 0x8F5C (36700 decimal) are the 16 least significant bits (LSW).

**19.10. MODBUS 4X HOLDING REGISTERS TABLE (FUNCTION CODE 3)**

ADDRESS (4x)	ADDRESS OFFSET	REGISTER	PHASE	DESCRIPTION	W/R	TYPE
40001	0	MACHINE-ID	-	Device ID	RO	UNSIGNED 16BIT
40002	1	FW REVISION (Maior/Minor)	-	FW revision	RO	UNSIGNED 16BIT
40003	2	FW REVISION (Fix/Build)	-	FW revision	RO	UNSIGNED 16BIT
40004	3	FW CODE	-	FW code	RO	UNSIGNED 16BIT
40005	4	FW RESERVED	-	-	RO	UNSIGNED 16BIT
40006	5	FW RESERVED	-	-	RO	UNSIGNED 16BIT
40007	6	BOARD-ID	-	HW revision	RO	UNSIGNED 16BIT
40008	7	BOOT REVISION (Maior/Minor)	-	FW Bootloader revision	RO	UNSIGNED 16BIT
40009	8	BOOT REVISION (Fix/Build)	-	FW Bootloader revision	RO	UNSIGNED 16BIT
40010	9	BOOT CODE	-	Bootloader FW code	RO	UNSIGNED 16BIT
40011	10	RESERVED	-	-	RO	UNSIGNED 16BIT
40012	11	RESERVED	-	-	RO	UNSIGNED 16BIT
40013	12	COMMAND AUX 3H	-	COMMAND REGISTER 3	RW	UNSIGNED 16BIT
40014	13	COMMAND AUX 3L	-		RW	UNSIGNED 16BIT
40015	14	COMMAND AUX 2	-	COMMAND REGISTER 2	RW	UNSIGNED 16BIT
40016	15	COMMAND AUX 1	-		RW	UNSIGNED 16BIT
40017	16	COMMAND	-	Supported command list:  260 decimal to reset MIN/MAX 259 decimal to reset AVG	RW	UNSIGNED 16BIT

ADDRESS (4x)	ADDRESS OFFSET	REGISTER	PHASE	DESCRIPTION	W/R	TYPE
				261 decimal to reset Energy Counters 40986 decimal to load value in CMD_AUX register to COUNTER1 41002 decimal to load value in CMD_AUX register to COUNTER2		
<b>40018</b>	17	STATUS	-	BIT0 -> Cyclic phase sense error (1 ERR, 0 OK) BIT1 -> ALARM ( 1 ACTIVE, 0 NOT ACTIVE) BIT2 -> DOUT1 status ( 1 ACTIVE, 0 NOT ACTIVE) BIT3 -> DOUT2 status ( 1 ACTIVE, 0 NOT ACTIVE) BIT4 -> DIN1 STATUS ( 1 high, 0 low) BIT5 -> DIN2 STATUS ( 1 high, 0 low) BIT6 -> Current Cutoff ( 1 active, 0 inactive) BIT 7 -> Current error L1 (1 CT connected reverse, 0 CT connected OK) BIT 8 -> Current error L2 (1 CT connected reverse, 0 CT connected OK) BIT 9 -> Current error L3 (1 CT connected inverted, 0 CT connected OK) BIT 10 -> Line 1 Voltage/Current connection error (1 Error, 0 OK) BIT 11 -> Connection error Line 2 Voltage/Current (1 Error, 0 OK) BIT 12 -> Connection error Line 3 Voltage/Current (1 Error, 0 OK)	RW	UNSIGNED 16BIT

ADDRESS (4x)	ADDRESS OFFSET	REGISTER	PHASE	DESCRIPTION	W/R	TYPE
40019	18	RESERVED	-	-	RW	UNSIGNED 16BIT
40020	19	RESERVED	-	-	RW	UNSIGNED 16BIT
40021	20	RESERVED	-	-	RW	UNSIGNED 16BIT
40022	21	INPUT VALUES	-	Status of digital inputs 1 and 2 Bit[0] = INPUT1 Bit[1] = INPUT2	RW	UNSIGNED 16BIT
40023	22	Output	-	Status of digital outputs Bit[0] = OUTPUT1 Bit[1] = OUTPUT2	RW	UNSIGNED 16BIT
40024	23	RESERVED	-	-	RW	UNSIGNED 16BIT
40025	24	RESERVED	-	-	RW	UNSIGNED 16BIT
40026	25	RESERVED	-	-	RW	UNSIGNED 16BIT
40027	26	ANALOG OUTPUT MANUAL	-	When the analogue output is in pilot "manual" mode the output 0=0% 8190=100%	RW	UNSIGNED 16BIT
40101	100	V RMS [V] MSW	L1-L2	RMS phase-to-phase voltage measurement in [V] (Set to 0 if Aron insertion is used)	RO	FLOAT32
40102	101	V RMS [V] LSW			RO	
40103	102	V RMS [V] MSW	L2-L3	RMS phase-to-phase voltage measurement in [V] (Set to 0 if Aron insertion is used)	RO	FLOAT32
40104	103	V RMS [V] LSW			RO	
40105	104	V RMS [V] MSW	L3-L1	RMS phase-to-phase voltage measurement in [V] (Set to 0 if Aron insertion is used)	RO	FLOAT32
40106	105	V RMS [V] LSW			RO	
40107	106	I RMS [A] MSW	L1	RMS current measurement in [A]	RO	FLOAT32
40108	107	I RMS [A] LSW			RO	
40109	108	I RMS [A] MSW	L2	RMS current measurement in [A]	RO	FLOAT32
40110	109	I RMS [A] LSW			RO	
40111	110	I RMS [A] MSW	L3	RMS current measurement in [A]	RO	FLOAT32
40112	111	I RMS [A] LSW			RO	



ADDRESS (4x)	ADDRESS OFFSET	REGISTER	PHASE	DESCRIPTION	W/R	TYPE
40113	112	I RMS [A] MSW	N	RMS current measurement in [A]	RO	FLOAT32
40114	113	I RMS [A] LSW			RO	
40115	114	V-I PHASE [°] MSW	L1	Measurement of the angle in [°] between Voltage and Current	RO	FLOAT32
40116	115	V-I PHASE [°] LSW			RO	
40117	116	V-I PHASE [°] MSW	L2	Measurement of the angle in [°] between Voltage and Current	RO	FLOAT32
40118	117	V-I PHASE [°] LSW			RO	
40119	118	V-I PHASE [°] MSW	L3	Measurement of the angle in [°] between Voltage and Current	RO	FLOAT32
40120	119	V-I PHASE [°] LSW			RO	
40121	120	P ACTIVE POWER [W] MSW	L1	Phase Active Power measurement in [W] "+" sign = Absorbed Active Power "-" sign = Generated Active Power	RO	FLOAT32
40122	121	P ACTIVE POWER [W] LSW			RO	
40123	122	P ACTIVE POWER [W] MSW	L2	Phase Active Power measurement in [W] "+" sign = Absorbed Active Power "-" sign = Generated Active Power	RO	FLOAT32
40124	123	P ACTIVE POWER [W] LSW			RO	
40125	124	P ACTIVE POWER [W] MSW	L3	Phase Active Power measurement in [W] "+" sign = Absorbed Active Power "-" sign = Generated Active Power	RO	FLOAT32
40126	125	P ACTIVE POWER [W] LSW			RO	
40127	126	Q REACTIVE POWER [VAR] MSW	L1	Phase Reactive Power measurement in [VAR]	RO	FLOAT32
40128	127	Q REACTIVE POWER [VAR] LSW			RO	
40129	128	Q REACTIVE POWER [VAR] MSW	L2	Phase Reactive Power measurement in [VAR]	RO	FLOAT32
40130	129	Q REACTIVE POWER [VAR] LSW			RO	
40131	130	Q REACTIVE POWER [VAR] MSW	L3	Phase Reactive Power measurement in [VAR]	RO	FLOAT32
40132	131	Q REACTIVE POWER [VAR] LSW			RO	
40133	132	S APPARENT POWER [VA] MSW	L1	Phase Apparent Power measurement in [VA]	RO	FLOAT32
40134	133	S APPARENT POWER [VA] LSW			RO	
40135	134	S APPARENT POWER [VA] MSW	L2	Phase Apparent Power measurement in [VA]	RO	FLOAT32
40136	135	S APPARENT POWER [VA] LSW			RO	
40137	136	S APPARENT POWER [VA] MSW	L3	Phase Apparent Power measurement in [VA]	RO	FLOAT32
40138	137	S APPARENT POWER [VA] LSW			RO	
40139	138	PF POWER FACTOR MSW	L1	Phase power factor measurement "+" sign = User "-" sign = Generator	RO	FLOAT32
40140	139	PF POWER FACTOR LSW			RO	

ADDRESS (4x)	ADDRESS OFFSET	REGISTER	PHASE	DESCRIPTION	W/R	TYPE
40141	140	PF POWER FACTOR MSW	L2	Phase power factor measurement "+" sign = User "- " sign = Generator	RO	FLOAT32
40142	141	PF POWER FACTOR LSW			RO	
40143	142	PF POWER FACTOR MSW	L3	Phase power factor measurement "+" sign = User "- " sign = Generator	RO	FLOAT32
40144	143	PF POWER FACTOR LSW			RO	
40145	144	F FREQUENCY [HZ] MSW	L1	Phase frequency measurement in [Hz]	RO	FLOAT32
40146	145	F FREQUENCY [HZ] LSW			RO	
40147	146	F FREQUENCY [HZ] MSW	L2	Phase frequency measurement in [Hz]	RO	FLOAT32
40148	147	F FREQUENCY [HZ] LSW			RO	
40149	148	F FREQUENCY [HZ] MSW	L3	Phase frequency measurement in [Hz]	RO	FLOAT32
40150	149	F FREQUENCY [HZ] LSW			RO	
40151	150	PERIOD [s] MSW	L1	Phase period measurement in [s]	RO	FLOAT32
40152	151	PERIOD [s] LSW			RO	
40153	152	PERIOD [s] MSW	L2	Phase period measurement in [s]	RO	FLOAT32
40154	153	PERIOD [s] LSW			RO	
40155	154	PERIOD [s] MSW	L3	Phase period measurement in [s]	RO	FLOAT32
40156	155	PERIOD [s] LSW			RO	
40157	156	V-V PHASE [°] MSW	L1-L2	Measurement of the angle in [°] between Voltage and Voltage	RO	FLOAT32
40158	157	V-V PHASE [°] LSW			RO	
40159	158	V-V PHASE [°] MSW	L2-L3	Measurement of the angle in [°] between Voltage and Voltage	RO	FLOAT32
40160	159	V-V PHASE [°] LSW			RO	
40161	160	V-V PHASE [°] MSW	L3-L1	Measurement of the angle in [°] between Voltage and Voltage	RO	FLOAT32
40162	161	V-V PHASE [°] LSW			RO	
40163	162	VLN rms [V] MSW	L1-N	Phase-neutral star voltage measurement (if Aron insertion is used, VL1N = V12)	RO	FLOAT32
40164	163	VLN rms [V] LSW			RO	
40165	164	VLN rms [V] MSW	L2-N	Phase-neutral star voltage measurement (if Aron insertion is used, VL2N = VL1N = V12)	RO	FLOAT32
40166	165	VLN rms [V] LSW			RO	
40167	166	VLN rms [V] MSW	L3-N	Phase-neutral star voltage measurement (if Aron insertion is used, VL3N = V32)	RO	FLOAT32
40168	167	VLN rms [V] LSW			RO	
40169	168	P TOTAL [W] MSW	3PH	Total Active Power measurement in [W] "+" sign = Absorbed Active Power	RO	FLOAT32
40170	169	P TOTAL [W] LSW			RO	

ADDRESS (4x)	ADDRESS OFFSET	REGISTER	PHASE	DESCRIPTION	W/R	TYPE
				"-" sign = Generated Active Power		
40171	170	Q TOTAL [VAR] MSW	3PH	Total Reactive Power measurement in [VAR]	RO	FLOAT32
40172	171	Q TOTAL [VAR] LSW			RO	
40173	172	S TOTAL [VA] MSW	3PH	Total Apparent Power measurement in [VA]	RO	FLOAT32
40174	173	S TOTAL [VA] LSW			RO	
40175	174	PF TOTAL MSW	3PH	Total power factor measurement "+" sign = User "-" sign = Generator	RO	FLOAT32
40176	175	PF TOTAL LSW			RO	
40177	176	THD V [%] MSW	L1	Measurement of the total voltage harmonic distortion in [%] in comparison with the fundamental	RO	FLOAT32
40178	177	THD V [%] LSW			RO	
40179	178	THD V [%] MSW	L2	Measurement of the total voltage harmonic distortion in [%] in comparison with the fundamental	RO	FLOAT32
40180	179	THD V [%] LSW			RO	
40181	180	THD V [%] MSW	L3	Measurement of the total voltage harmonic distortion in [%] in comparison with the fundamental	RO	FLOAT32
40182	181	THD V [%] LSW			RO	
40183	182	THD I [%] MSW	L1	Measurement of the total current harmonic distortion in [%] in comparison with the fundamental	RO	FLOAT32
40184	183	THD I [%] LSW			RO	
40185	184	THD I [%] MSW	L2	Measurement of the total current harmonic distortion in [%] in comparison with the fundamental	RO	FLOAT32
40186	185	THD I [%] LSW			RO	
40187	186	THD I [%] MSW	L3	Measurement of the total current harmonic distortion in [%] in comparison with the fundamental	RO	FLOAT32
40188	187	THD I [%] LSW			RO	
40189	188	VRMS FUNDAMENTAL [V] MSW	L1-N	Measurement of the Phase - Neutral VRMS of the fundamental alone [V]	RO	FLOAT32
40190	189	VRMS FUNDAMENTAL [V] LSW			RO	
40191	190	VRMS FUNDAMENTAL [V] MSW	L2-N	Measurement of the Phase - Neutral VRMS of the fundamental alone [V]	RO	FLOAT32
40192	191	VRMS FUNDAMENTAL [V] LSW			RO	
40193	192	VRMS FUNDAMENTAL [V] MSW	L3-N		RO	FLOAT32

ADDRESS (4x)	ADDRESS OFFSET	REGISTER	PHASE	DESCRIPTION	W/R	TYPE
40194	193	VRMS FUNDAMENTAL [V] LSW		Measurement of the Phase - Neutral VRMS of the fundamental alone [V]	RO	
40195	194	VRMS HARMONIC 2 [V] MSW	L1-N	Measurement of the Phase - Neutral VRMS of the i-th harmonic [V]	RO	FLOAT32
40196	195	VRMS HARMONIC 2 [V] LSW			RO	
40197	196	VRMS HARMONIC 2 [V] MSW	L2-N	Measurement of the Phase - Neutral VRMS of the i-th harmonic [V]	RO	FLOAT32
40198	197	VRMS HARMONIC 2 [V] LSW			RO	
40199	198	VRMS HARMONIC 2 [V] MSW	L3-N	Measurement of the Phase - Neutral VRMS of the i-th harmonic [V]	RO	FLOAT32
40200	199	VRMS HARMONIC 2 [V] LSW			RO	
40201	200	VRMS HARMONIC 3 [V] MSW	L1-N	Measurement of the Phase - Neutral VRMS of the i-th harmonic [V]	RO	FLOAT32
40202	201	VRMS HARMONIC 3 [V] LSW			RO	
40203	202	VRMS HARMONIC 3 [V] MSW	L2-N	Measurement of the Phase - Neutral VRMS of the i-th harmonic [V]	RO	FLOAT32
40204	203	VRMS HARMONIC 3 [V] LSW			RO	
40205	204	VRMS HARMONIC 3 [V] MSW	L3-N	Measurement of the Phase - Neutral VRMS of the i-th harmonic [V]	RO	FLOAT32
40206	205	VRMS HARMONIC 3 [V] LSW			RO	
40207	206	VRMS HARMONIC 4 [V] MSW	L1-N	Measurement of the Phase - Neutral VRMS of the i-th harmonic [V]	RO	FLOAT32
40208	207	VRMS HARMONIC 4 [V] LSW			RO	
40209	208	VRMS HARMONIC 4 [V] MSW	L2-N	Measurement of the Phase - Neutral VRMS of the i-th harmonic [V]	RO	FLOAT32
40210	209	VRMS HARMONIC 4 [V] LSW			RO	
40211	210	VRMS HARMONIC 4 [V] MSW	L3-N	Measurement of the Phase - Neutral VRMS of the i-th harmonic [V]	RO	FLOAT32
40212	211	VRMS HARMONIC 4 [V] LSW			RO	
40213	212	VRMS HARMONIC 5 [V] MSW	L1-N	Measurement of the Phase - Neutral VRMS of the i-th harmonic [V]	RO	FLOAT32
40214	213	VRMS HARMONIC 5 [V] LSW			RO	
40215	214	VRMS HARMONIC 5 [V] MSW	L2-N	Measurement of the Phase - Neutral VRMS of the i-th harmonic [V]	RO	FLOAT32
40216	215	VRMS HARMONIC 5 [V] LSW			RO	
40217	216	VRMS HARMONIC 5 [V] MSW	L3-N	Measurement of the Phase - Neutral VRMS	RO	FLOAT32
40218	217	VRMS HARMONIC 5 [V] LSW			RO	

ADDRESS (4x)	ADDRESS OFFSET	REGISTER	PHASE	DESCRIPTION	W/R	TYPE
				of the i-th harmonic [V]		
40219	218	VRMS HARMONIC 6 [V] MSW	L1-N	Measurement of the Phase - Neutral VRMS of the i-th harmonic [V]	RO	FLOAT32
40220	219	VRMS HARMONIC 6 [V] LSW			RO	
40221	220	VRMS HARMONIC 6 [V] MSW	L2-N	Measurement of the Phase - Neutral VRMS of the i-th harmonic [V]	RO	FLOAT32
40222	221	VRMS HARMONIC 6 [V] LSW			RO	
40223	222	VRMS HARMONIC 6 [V] MSW	L3-N	Measurement of the Phase - Neutral VRMS of the i-th harmonic [V]	RO	FLOAT32
40224	223	VRMS HARMONIC 6 [V] LSW			RO	
40225	224	VRMS HARMONIC 7 [V] MSW	L1-N	Measurement of the Phase - Neutral VRMS of the i-th harmonic [V]	RO	FLOAT32
40226	225	VRMS HARMONIC 7 [V] LSW			RO	
40227	226	VRMS HARMONIC 7 [V] MSW	L2-N	Measurement of the Phase - Neutral VRMS of the i-th harmonic [V]	RO	FLOAT32
40228	227	VRMS HARMONIC 7 [V] LSW			RO	
40229	228	VRMS HARMONIC 7 [V] MSW	L3-N	Measurement of the Phase - Neutral VRMS of the i-th harmonic [V]	RO	FLOAT32
40230	229	VRMS HARMONIC 7 [V] LSW			RO	
40231	230	VRMS HARMONIC 8 [V] MSW	L1-N	Measurement of the Phase - Neutral VRMS of the i-th harmonic [V]	RO	FLOAT32
40232	231	VRMS HARMONIC 8 [V] LSW			RO	
40233	232	VRMS HARMONIC 8 [V] MSW	L2-N	Measurement of the Phase - Neutral VRMS of the i-th harmonic [V]	RO	FLOAT32
40234	233	VRMS HARMONIC 8 [V] LSW			RO	
40235	234	VRMS HARMONIC 8 [V] MSW	L3-N	Measurement of the Phase - Neutral VRMS of the i-th harmonic [V]	RO	FLOAT32
40236	235	VRMS HARMONIC 8 [V] LSW			RO	
40237	236	VRMS HARMONIC 9 [V] MSW	L1-N	Measurement of the Phase - Neutral VRMS of the i-th harmonic [V]	RO	FLOAT32
40238	237	VRMS HARMONIC 9 [V] LSW			RO	
40239	238	VRMS HARMONIC 9 [V] MSW	L2-N	Measurement of the Phase - Neutral VRMS of the i-th harmonic [V]	RO	FLOAT32
40240	239	VRMS HARMONIC 9 [V] LSW			RO	
40241	240	VRMS HARMONIC 9 [V] MSW	L3-N	Measurement of the Phase - Neutral VRMS of the i-th harmonic [V]	RO	FLOAT32
40242	241	VRMS HARMONIC 9 [V] LSW			RO	

ADDRESS (4x)	ADDRESS OFFSET	REGISTER	PHASE	DESCRIPTION	W/R	TYPE
40243	242	VRMS HARMONIC 10 [V] MSW	L1-N	Measurement of the Phase - Neutral VRMS of the i-th harmonic [V]	RO	FLOAT32
40244	243	VRMS HARMONIC 10 [V] LSW			RO	
40245	244	VRMS HARMONIC 10 [V] MSW	L2-N	Measurement of the Phase - Neutral VRMS of the i-th harmonic [V]	RO	FLOAT32
40246	245	VRMS HARMONIC 10 [V] LSW			RO	
40247	246	VRMS HARMONIC 10 [V] MSW	L3-N	Measurement of the Phase - Neutral VRMS of the i-th harmonic [V]	RO	FLOAT32
40248	247	VRMS HARMONIC 10 [V] LSW			RO	
40249	248	VRMS HARMONIC 11 [V] MSW	L1-N	Measurement of the Phase - Neutral VRMS of the i-th harmonic [V]	RO	FLOAT32
40250	249	VRMS HARMONIC 11 [V] LSW			RO	
40251	250	VRMS HARMONIC 11 [V] MSW	L2-N	Measurement of the Phase - Neutral VRMS of the i-th harmonic [V]	RO	FLOAT32
40252	251	VRMS HARMONIC 11 [V] LSW			RO	
40253	252	VRMS HARMONIC 11 [V] MSW	L3-N	Measurement of the Phase - Neutral VRMS of the i-th harmonic [V]	RO	FLOAT32
40254	253	VRMS HARMONIC 11 [V] LSW			RO	
40255	254	VRMS HARMONIC 12 [V] MSW	L1-N	Measurement of the Phase - Neutral VRMS of the i-th harmonic [V]	RO	FLOAT32
40256	255	VRMS HARMONIC 12 [V] LSW			RO	
40257	256	VRMS HARMONIC 12 [V] MSW	L2-N	Measurement of the Phase - Neutral VRMS of the i-th harmonic [V]	RO	FLOAT32
40258	257	VRMS HARMONIC 12 [V] LSW			RO	
40259	258	VRMS HARMONIC 12 [V] MSW	L3-N	Measurement of the Phase - Neutral VRMS of the i-th harmonic [V]	RO	FLOAT32
40260	259	VRMS HARMONIC 12 [V] LSW			RO	
40261	260	VRMS HARMONIC 13 [V] MSW	L1-N	Measurement of the Phase - Neutral VRMS of the i-th harmonic [V]	RO	FLOAT32
40262	261	VRMS HARMONIC 13 [V] LSW			RO	
40263	262	VRMS HARMONIC 13 [V] MSW	L2-N	Measurement of the Phase - Neutral VRMS of the i-th harmonic [V]	RO	FLOAT32
40264	263	VRMS HARMONIC 13 [V] LSW			RO	
40265	264	VRMS HARMONIC 13 [V] MSW	L3-N	Measurement of the Phase - Neutral VRMS of the i-th harmonic [V]	RO	FLOAT32
40266	265	VRMS HARMONIC 13 [V] LSW			RO	
40267	266	VRMS HARMONIC 14 [V] MSW	L1-N	Measurement of the Phase - Neutral VRMS	RO	FLOAT32
40268	267	VRMS HARMONIC 14 [V] LSW			RO	

ADDRESS (4x)	ADDRESS OFFSET	REGISTER	PHASE	DESCRIPTION	W/R	TYPE
				of the i-th harmonic [V]		
40269	268	VRMS HARMONIC 14 [V] MSW	L2-N	Measurement of the Phase - Neutral VRMS of the i-th harmonic [V]	RO	FLOAT32
40270	269	VRMS HARMONIC 14 [V] LSW			RO	
40271	270	VRMS HARMONIC 14 [V] MSW	L3-N	Measurement of the Phase - Neutral VRMS of the i-th harmonic [V]	RO	FLOAT32
40272	271	VRMS HARMONIC 14 [V] LSW			RO	
40273	272	VRMS HARMONIC 15 [V] MSW	L1-N	Measurement of the Phase - Neutral VRMS of the i-th harmonic [V]	RO	FLOAT32
40274	273	VRMS HARMONIC 15 [V] LSW			RO	
40275	274	VRMS HARMONIC 15 [V] MSW	L2-N	Measurement of the Phase - Neutral VRMS of the i-th harmonic [V]	RO	FLOAT32
40276	275	VRMS HARMONIC 15 [V] LSW			RO	
40277	276	VRMS HARMONIC 15 [V] MSW	L3-N	Measurement of the Phase - Neutral VRMS of the i-th harmonic [V]	RO	FLOAT32
40278	277	VRMS HARMONIC 15 [V] LSW			RO	
40279	278	VRMS HARMONIC 16 [V] MSW	L1-N	Measurement of the Phase - Neutral VRMS of the i-th harmonic [V]	RO	FLOAT32
40280	279	VRMS HARMONIC 16 [V] LSW			RO	
40281	280	VRMS HARMONIC 16 [V] MSW	L2-N	Measurement of the Phase - Neutral VRMS of the i-th harmonic [V]	RO	FLOAT32
40282	281	VRMS HARMONIC 16 [V] LSW			RO	
40283	282	VRMS HARMONIC 16 [V] MSW	L3-N	Measurement of the Phase - Neutral VRMS of the i-th harmonic [V]	RO	FLOAT32
40284	283	VRMS HARMONIC 16 [V] LSW			RO	
40285	284	VRMS HARMONIC 17 [V] MSW	L1-N	Measurement of the Phase - Neutral VRMS of the i-th harmonic [V]	RO	FLOAT32
40286	285	VRMS HARMONIC 17 [V] LSW			RO	
40287	286	VRMS HARMONIC 17 [V] MSW	L2-N	Measurement of the Phase - Neutral VRMS of the i-th harmonic [V]	RO	FLOAT32
40288	287	VRMS HARMONIC 17 [V] LSW			RO	
40289	288	VRMS HARMONIC 17 [V] MSW	L3-N	Measurement of the Phase - Neutral VRMS of the i-th harmonic [V]	RO	FLOAT32
40290	289	VRMS HARMONIC 17 [V] LSW			RO	
40291	290	VRMS HARMONIC 18 [V] MSW	L1-N	Measurement of the Phase - Neutral VRMS of the i-th harmonic [V]	RO	FLOAT32
40292	291	VRMS HARMONIC 18 [V] LSW			RO	

ADDRESS (4x)	ADDRESS OFFSET	REGISTER	PHASE	DESCRIPTION	W/R	TYPE
40293	292	VRMS HARMONIC 18 [V] MSW	L2-N	Measurement of the Phase - Neutral VRMS of the i-th harmonic [V]	RO	FLOAT32
40294	293	VRMS HARMONIC 18 [V] LSW			RO	
40295	294	VRMS HARMONIC 18 [V] MSW	L3-N	Measurement of the Phase - Neutral VRMS of the i-th harmonic [V]	RO	FLOAT32
40296	295	VRMS HARMONIC 18 [V] LSW			RO	
40297	296	VRMS HARMONIC 19 [V] MSW	L1-N	Measurement of the Phase - Neutral VRMS of the i-th harmonic [V]	RO	FLOAT32
40298	297	VRMS HARMONIC 19 [V] LSW			RO	
40299	298	VRMS HARMONIC 19 [V] MSW	L2-N	Measurement of the Phase - Neutral VRMS of the i-th harmonic [V]	RO	FLOAT32
40300	299	VRMS HARMONIC 19 [V] LSW			RO	
40301	300	VRMS HARMONIC 19 [V] MSW	L3-N	Measurement of the Phase - Neutral VRMS of the i-th harmonic [V]	RO	FLOAT32
40302	301	VRMS HARMONIC 19 [V] LSW			RO	
40303	302	VRMS HARMONIC 20 [V] MSW	L1-N	Measurement of the Phase - Neutral VRMS of the i-th harmonic [V]	RO	FLOAT32
40304	303	VRMS HARMONIC 20 [V] LSW			RO	
40305	304	VRMS HARMONIC 20 [V] MSW	L2-N	Measurement of the Phase - Neutral VRMS of the i-th harmonic [V]	RO	FLOAT32
40306	305	VRMS HARMONIC 20 [V] LSW			RO	
40307	306	VRMS HARMONIC 20 [V] MSW	L3-N	Measurement of the Phase - Neutral VRMS of the i-th harmonic [V]	RO	FLOAT32
40308	307	VRMS HARMONIC 20 [V] LSW			RO	
40309	308	VRMS HARMONIC 21 [V] MSW	L1-N	Measurement of the Phase - Neutral VRMS of the i-th harmonic [V]	RO	FLOAT32
40310	309	VRMS HARMONIC 21 [V] LSW			RO	
40311	310	VRMS HARMONIC 21 [V] MSW	L2-N	Measurement of the Phase - Neutral VRMS of the i-th harmonic [V]	RO	FLOAT32
40312	311	VRMS HARMONIC 21 [V] LSW			RO	
40313	312	VRMS HARMONIC 21 [V] MSW	L3-N	Measurement of the Phase - Neutral VRMS of the i-th harmonic [V]	RO	FLOAT32
40314	313	VRMS HARMONIC 21 [V] LSW			RO	
40315	314	VRMS HARMONIC 22 [V] MSW	L1-N	Measurement of the Phase - Neutral VRMS of the i-th harmonic [V]	RO	FLOAT32
40316	315	VRMS HARMONIC 22 [V] LSW			RO	
40317	316	VRMS HARMONIC 22 [V] MSW	L2-N	Measurement of the Phase - Neutral VRMS	RO	FLOAT32
40318	317	VRMS HARMONIC 22 [V] LSW			RO	



ADDRESS (4x)	ADDRESS OFFSET	REGISTER	PHASE	DESCRIPTION	W/R	TYPE
				of the i-th harmonic [V]		
<b>40319</b>	318	VRMS HARMONIC 22 [V] MSW	L3-N	Measurement of the Phase - Neutral VRMS of the i-th harmonic [V]	RO	FLOAT32
<b>40320</b>	319	VRMS HARMONIC 22 [V] LSW			RO	
<b>40321</b>	320	VRMS HARMONIC 23 [V] MSW	L1-N	Measurement of the Phase - Neutral VRMS of the i-th harmonic [V]	RO	FLOAT32
<b>40322</b>	321	VRMS HARMONIC 23 [V] LSW			RO	
<b>40323</b>	322	VRMS HARMONIC 23 [V] MSW	L2-N	Measurement of the Phase - Neutral VRMS of the i-th harmonic [V]	RO	FLOAT32
<b>40324</b>	323	VRMS HARMONIC 23 [V] LSW			RO	
<b>40325</b>	324	VRMS HARMONIC 23 [V] MSW	L3-N	Measurement of the Phase - Neutral VRMS of the i-th harmonic [V]	RO	FLOAT32
<b>40326</b>	325	VRMS HARMONIC 23 [V] LSW			RO	
<b>40327</b>	326	VRMS HARMONIC 24 [V] MSW	L1-N	Measurement of the Phase - Neutral VRMS of the i-th harmonic [V]	RO	FLOAT32
<b>40328</b>	327	VRMS HARMONIC 24 [V] LSW			RO	
<b>40329</b>	328	VRMS HARMONIC 24 [V] MSW	L2-N	Measurement of the Phase - Neutral VRMS of the i-th harmonic [V]	RO	FLOAT32
<b>40330</b>	329	VRMS HARMONIC 24 [V] LSW			RO	
<b>40331</b>	330	VRMS HARMONIC 24 [V] MSW	L3-N	Measurement of the Phase - Neutral VRMS of the i-th harmonic [V]	RO	FLOAT32
<b>40332</b>	331	VRMS HARMONIC 24 [V] LSW			RO	
<b>40333</b>	332	VRMS HARMONIC 25 [V] MSW	L1-N	Measurement of the Phase - Neutral VRMS of the i-th harmonic [V]	RO	FLOAT32
<b>40334</b>	333	VRMS HARMONIC 25 [V] LSW			RO	
<b>40335</b>	334	VRMS HARMONIC 25 [V] MSW	L2-N	Measurement of the Phase - Neutral VRMS of the i-th harmonic [V]	RO	FLOAT32
<b>40336</b>	335	VRMS HARMONIC 25 [V] LSW			RO	
<b>40337</b>	336	VRMS HARMONIC 25 [V] MSW	L3-N	Measurement of the Phase - Neutral VRMS of the i-th harmonic [V]	RO	FLOAT32
<b>40338</b>	337	VRMS HARMONIC 25 [V] LSW			RO	
<b>40339</b>	338	VRMS HARMONIC 26 [V] MSW	L1-N	Measurement of the Phase - Neutral VRMS of the i-th harmonic [V]	RO	FLOAT32
<b>40340</b>	339	VRMS HARMONIC 26 [V] LSW			RO	
<b>40341</b>	340	VRMS HARMONIC 26 [V] MSW	L2-N	Measurement of the Phase - Neutral VRMS of the i-th harmonic [V]	RO	FLOAT32
<b>40342</b>	341	VRMS HARMONIC 26 [V] LSW			RO	

ADDRESS (4x)	ADDRESS OFFSET	REGISTER	PHASE	DESCRIPTION	W/R	TYPE
40343	342	VRMS HARMONIC 26 [V] MSW	L3-N	Measurement of the Phase - Neutral VRMS of the i-th harmonic [V]	RO	FLOAT32
40344	343	VRMS HARMONIC 26 [V] LSW			RO	
40345	344	VRMS HARMONIC 27 [V] MSW	L1-N	Measurement of the Phase - Neutral VRMS of the i-th harmonic [V]	RO	FLOAT32
40346	345	VRMS HARMONIC 27 [V] LSW			RO	
40347	346	VRMS HARMONIC 27 [V] MSW	L2-N	Measurement of the Phase - Neutral VRMS of the i-th harmonic [V]	RO	FLOAT32
40348	347	VRMS HARMONIC 27 [V] LSW			RO	
40349	348	VRMS HARMONIC 27 [V] MSW	L3-N	Measurement of the Phase - Neutral VRMS of the i-th harmonic [V]	RO	FLOAT32
40350	349	VRMS HARMONIC 27 [V] LSW			RO	
40351	350	VRMS HARMONIC 28 [V] MSW	L1-N	Measurement of the Phase - Neutral VRMS of the i-th harmonic [V]	RO	FLOAT32
40352	351	VRMS HARMONIC 28 [V] LSW			RO	
40353	352	VRMS HARMONIC 28 [V] MSW	L2-N	Measurement of the Phase - Neutral VRMS of the i-th harmonic [V]	RO	FLOAT32
40354	353	VRMS HARMONIC 28 [V] LSW			RO	
40355	354	VRMS HARMONIC 28 [V] MSW	L3-N	Measurement of the Phase - Neutral VRMS of the i-th harmonic [V]	RO	FLOAT32
40356	355	VRMS HARMONIC 28 [V] LSW			RO	
40357	356	VRMS HARMONIC 29 [V] MSW	L1-N	Measurement of the Phase - Neutral VRMS of the i-th harmonic [V]	RO	FLOAT32
40358	357	VRMS HARMONIC 29 [V] LSW			RO	
40359	358	VRMS HARMONIC 29 [V] MSW	L2-N	Measurement of the Phase - Neutral VRMS of the i-th harmonic [V]	RO	FLOAT32
40360	359	VRMS HARMONIC 29 [V] LSW			RO	
40361	360	VRMS HARMONIC 29 [V] MSW	L3-N	Measurement of the Phase - Neutral VRMS of the i-th harmonic [V]	RO	FLOAT32
40362	361	VRMS HARMONIC 29 [V] LSW			RO	
40363	362	VRMS HARMONIC 30 [V] MSW	L1-N	Measurement of the Phase - Neutral VRMS of the i-th harmonic [V]	RO	FLOAT32
40364	363	VRMS HARMONIC 30 [V] LSW			RO	
40365	364	VRMS HARMONIC 30 [V] MSW	L2-N	Measurement of the Phase - Neutral VRMS of the i-th harmonic [V]	RO	FLOAT32
40366	365	VRMS HARMONIC 30 [V] LSW			RO	
40367	366	VRMS HARMONIC 30 [V] MSW	L3-N	Measurement of the Phase - Neutral VRMS	RO	FLOAT32
40368	367	VRMS HARMONIC 30 [V] LSW			RO	

ADDRESS (4x)	ADDRESS OFFSET	REGISTER	PHASE	DESCRIPTION	W/R	TYPE
				of the i-th harmonic [V]		
40369	368	VRMS HARMONIC 31 [V] MSW	L1-N	Measurement of the Phase - Neutral VRMS of the i-th harmonic [V]	RO	FLOAT32
40370	369	VRMS HARMONIC 31 [V] LSW			RO	
40371	370	VRMS HARMONIC 31 [V] MSW	L2-N	Measurement of the Phase - Neutral VRMS of the i-th harmonic [V]	RO	FLOAT32
40372	371	VRMS HARMONIC 31 [V] LSW			RO	
40373	372	VRMS HARMONIC 31 [V] MSW	L3-N	Measurement of the Phase - Neutral VRMS of the i-th harmonic [V]	RO	FLOAT32
40374	373	VRMS HARMONIC 31 [V] LSW			RO	
40375	374	VRMS HARMONIC 32 [V] MSW	L1-N	Measurement of the Phase - Neutral VRMS of the i-th harmonic [V]	RO	FLOAT32
40376	375	VRMS HARMONIC 32 [V] LSW			RO	
40377	376	VRMS HARMONIC 32 [V] MSW	L2-N	Measurement of the Phase - Neutral VRMS of the i-th harmonic [V]	RO	FLOAT32
40378	377	VRMS HARMONIC 32 [V] LSW			RO	
40379	378	VRMS HARMONIC 32 [V] MSW	L3-N	Measurement of the Phase - Neutral VRMS of the i-th harmonic [V]	RO	FLOAT32
40380	379	VRMS HARMONIC 32 [V] LSW			RO	
40381	380	VRMS HARMONIC 33 [V] MSW	L1-N	Measurement of the Phase - Neutral VRMS of the i-th harmonic [V]	RO	FLOAT32
40382	381	VRMS HARMONIC 33 [V] LSW			RO	
40383	382	VRMS HARMONIC 33 [V] MSW	L2-N	Measurement of the Phase - Neutral VRMS of the i-th harmonic [V]	RO	FLOAT32
40384	383	VRMS HARMONIC 33 [V] LSW			RO	
40385	384	VRMS HARMONIC 33 [V] MSW	L3-N	Measurement of the Phase - Neutral VRMS of the i-th harmonic [V]	RO	FLOAT32
40386	385	VRMS HARMONIC 33 [V] LSW			RO	
40387	386	VRMS HARMONIC 34 [V] MSW	L1-N	Measurement of the Phase - Neutral VRMS of the i-th harmonic [V]	RO	FLOAT32
40388	387	VRMS HARMONIC 34 [V] LSW			RO	
40389	388	VRMS HARMONIC 34 [V] MSW	L2-N	Measurement of the Phase - Neutral VRMS of the i-th harmonic [V]	RO	FLOAT32
40390	389	VRMS HARMONIC 34 [V] LSW			RO	
40391	390	VRMS HARMONIC 34 [V] MSW	L3-N	Measurement of the Phase - Neutral VRMS of the i-th harmonic [V]	RO	FLOAT32
40392	391	VRMS HARMONIC 34 [V] LSW			RO	

ADDRESS (4x)	ADDRESS OFFSET	REGISTER	PHASE	DESCRIPTION	W/R	TYPE
40393	392	VRMS HARMONIC 35 [V] MSW	L1-N	Measurement of the Phase - Neutral VRMS of the i-th harmonic [V]	RO	FLOAT32
40394	393	VRMS HARMONIC 35 [V] LSW			RO	
40395	394	VRMS HARMONIC 35 [V] MSW	L2-N	Measurement of the Phase - Neutral VRMS of the i-th harmonic [V]	RO	FLOAT32
40396	395	VRMS HARMONIC 35 [V] LSW			RO	
40397	396	VRMS HARMONIC 35 [V] MSW	L3-N	Measurement of the Phase - Neutral VRMS of the i-th harmonic [V]	RO	FLOAT32
40398	397	VRMS HARMONIC 35 [V] LSW			RO	
40399	398	VRMS HARMONIC 36 [V] MSW	L1-N	Measurement of the Phase - Neutral VRMS of the i-th harmonic [V]	RO	FLOAT32
40400	399	VRMS HARMONIC 36 [V] LSW			RO	
40401	400	VRMS HARMONIC 36 [V] MSW	L2-N	Measurement of the Phase - Neutral VRMS of the i-th harmonic [V]	RO	FLOAT32
40402	401	VRMS HARMONIC 36 [V] LSW			RO	
40403	402	VRMS HARMONIC 36 [V] MSW	L3-N	Measurement of the Phase - Neutral VRMS of the i-th harmonic [V]	RO	FLOAT32
40404	403	VRMS HARMONIC 36 [V] LSW			RO	
40405	404	VRMS HARMONIC 37 [V] MSW	L1-N	Measurement of the Phase - Neutral VRMS of the i-th harmonic [V]	RO	FLOAT32
40406	405	VRMS HARMONIC 37 [V] LSW			RO	
40407	406	VRMS HARMONIC 37 [V] MSW	L2-N	Measurement of the Phase - Neutral VRMS of the i-th harmonic [V]	RO	FLOAT32
40408	407	VRMS HARMONIC 37 [V] LSW			RO	
40409	408	VRMS HARMONIC 37 [V] MSW	L3-N	Measurement of the Phase - Neutral VRMS of the i-th harmonic [V]	RO	FLOAT32
40410	409	VRMS HARMONIC 37 [V] LSW			RO	
40411	410	VRMS HARMONIC 38 [V] MSW	L1-N	Measurement of the Phase - Neutral VRMS of the i-th harmonic [V]	RO	FLOAT32
40412	411	VRMS HARMONIC 38 [V] LSW			RO	
40413	412	VRMS HARMONIC 38 [V] MSW	L2-N	Measurement of the Phase - Neutral VRMS of the i-th harmonic [V]	RO	FLOAT32
40414	413	VRMS HARMONIC 38 [V] LSW			RO	
40415	414	VRMS HARMONIC 38 [V] MSW	L3-N	Measurement of the Phase - Neutral VRMS of the i-th harmonic [V]	RO	FLOAT32
40416	415	VRMS HARMONIC 38 [V] LSW			RO	
40417	416	VRMS HARMONIC 39 [V] MSW	L1-N	Measurement of the Phase - Neutral VRMS	RO	FLOAT32
40418	417	VRMS HARMONIC 39 [V] LSW			RO	

ADDRESS (4x)	ADDRESS OFFSET	REGISTER	PHASE	DESCRIPTION	W/R	TYPE
				of the i-th harmonic [V]		
<b>40419</b>	418	VRMS HARMONIC 39 [V] MSW	L2-N	Measurement of the Phase - Neutral VRMS of the i-th harmonic [V]	RO	FLOAT32
<b>40420</b>	419	VRMS HARMONIC 39 [V] LSW			RO	
<b>40421</b>	420	VRMS HARMONIC 39 [V] MSW	L3-N	Measurement of the Phase - Neutral VRMS of the i-th harmonic [V]	RO	FLOAT32
<b>40422</b>	421	VRMS HARMONIC 39 [V] LSW			RO	
<b>40423</b>	422	VRMS HARMONIC 40 [V] MSW	L1-N	Measurement of the Phase - Neutral VRMS of the i-th harmonic [V]	RO	FLOAT32
<b>40424</b>	423	VRMS HARMONIC 40 [V] LSW			RO	
<b>40425</b>	424	VRMS HARMONIC 40 [V] MSW	L2-N	Measurement of the Phase - Neutral VRMS of the i-th harmonic [V]	RO	FLOAT32
<b>40426</b>	425	VRMS HARMONIC 40 [V] LSW			RO	
<b>40427</b>	426	VRMS HARMONIC 40 [V] MSW	L3-N	Measurement of the Phase - Neutral VRMS of the i-th harmonic [V]	RO	FLOAT32
<b>40428</b>	427	VRMS HARMONIC 40 [V] LSW			RO	
<b>40429</b>	428	VRMS HARMONIC 41 [V] MSW	L1-N	Measurement of the Phase - Neutral VRMS of the i-th harmonic [V]	RO	FLOAT32
<b>40430</b>	429	VRMS HARMONIC 41 [V] LSW			RO	
<b>40431</b>	430	VRMS HARMONIC 41 [V] MSW	L2-N	Measurement of the Phase - Neutral VRMS of the i-th harmonic [V]	RO	FLOAT32
<b>40432</b>	431	VRMS HARMONIC 41 [V] LSW			RO	
<b>40433</b>	432	VRMS HARMONIC 41 [V] MSW	L3-N	Measurement of the Phase - Neutral VRMS of the i-th harmonic [V]	RO	FLOAT32
<b>40434</b>	433	VRMS HARMONIC 41 [V] LSW			RO	
<b>40435</b>	434	VRMS HARMONIC 42 [V] MSW	L1-N	Measurement of the Phase - Neutral VRMS of the i-th harmonic [V]	RO	FLOAT32
<b>40436</b>	435	VRMS HARMONIC 42 [V] LSW			RO	
<b>40437</b>	436	VRMS HARMONIC 42 [V] MSW	L2-N	Measurement of the Phase - Neutral VRMS of the i-th harmonic [V]	RO	FLOAT32
<b>40438</b>	437	VRMS HARMONIC 42 [V] LSW			RO	
<b>40439</b>	438	VRMS HARMONIC 42 [V] MSW	L3-N	Measurement of the Phase - Neutral VRMS of the i-th harmonic [V]	RO	FLOAT32
<b>40440</b>	439	VRMS HARMONIC 42 [V] LSW			RO	
<b>40441</b>	440	VRMS HARMONIC 43 [V] MSW	L1-N	Measurement of the Phase - Neutral VRMS of the i-th harmonic [V]	RO	FLOAT32
<b>40442</b>	441	VRMS HARMONIC 43 [V] LSW			RO	

ADDRESS (4x)	ADDRESS OFFSET	REGISTER	PHASE	DESCRIPTION	W/R	TYPE
40443	442	VRMS HARMONIC 43 [V] MSW	L2-N	Measurement of the Phase - Neutral VRMS of the i-th harmonic [V]	RO	FLOAT32
40444	443	VRMS HARMONIC 43 [V] LSW			RO	
40445	444	VRMS HARMONIC 43 [V] MSW	L3-N	Measurement of the Phase - Neutral VRMS of the i-th harmonic [V]	RO	FLOAT32
40446	445	VRMS HARMONIC 43 [V] LSW			RO	
40447	446	VRMS HARMONIC 44 [V] MSW	L1-N	Measurement of the Phase - Neutral VRMS of the i-th harmonic [V]	RO	FLOAT32
40448	447	VRMS HARMONIC 44 [V] LSW			RO	
40449	448	VRMS HARMONIC 44 [V] MSW	L2-N	Measurement of the Phase - Neutral VRMS of the i-th harmonic [V]	RO	FLOAT32
40450	449	VRMS HARMONIC 44 [V] LSW			RO	
40451	450	VRMS HARMONIC 44 [V] MSW	L3-N	Measurement of the Phase - Neutral VRMS of the i-th harmonic [V]	RO	FLOAT32
40452	451	VRMS HARMONIC 44 [V] LSW			RO	
40453	452	VRMS HARMONIC 45 [V] MSW	L1-N	Measurement of the Phase - Neutral VRMS of the i-th harmonic [V]	RO	FLOAT32
40454	453	VRMS HARMONIC 45 [V] LSW			RO	
40455	454	VRMS HARMONIC 45 [V] MSW	L2-N	Measurement of the Phase - Neutral VRMS of the i-th harmonic [V]	RO	FLOAT32
40456	455	VRMS HARMONIC 45 [V] LSW			RO	
40457	456	VRMS HARMONIC 45 [V] MSW	L3-N	Measurement of the Phase - Neutral VRMS of the i-th harmonic [V]	RO	FLOAT32
40458	457	VRMS HARMONIC 45 [V] LSW			RO	
40459	458	VRMS HARMONIC 46 [V] MSW	L1-N	Measurement of the Phase - Neutral VRMS of the i-th harmonic [V]	RO	FLOAT32
40460	459	VRMS HARMONIC 46 [V] LSW			RO	
40461	460	VRMS HARMONIC 46 [V] MSW	L2-N	Measurement of the Phase - Neutral VRMS of the i-th harmonic [V]	RO	FLOAT32
40462	461	VRMS HARMONIC 46 [V] LSW			RO	
40463	462	VRMS HARMONIC 46 [V] MSW	L3-N	Measurement of the Phase - Neutral VRMS of the i-th harmonic [V]	RO	FLOAT32
40464	463	VRMS HARMONIC 46 [V] LSW			RO	
40465	464	VRMS HARMONIC 47 [V] MSW	L1-N	Measurement of the Phase - Neutral VRMS of the i-th harmonic [V]	RO	FLOAT32
40466	465	VRMS HARMONIC 47 [V] LSW			RO	
40467	466	VRMS HARMONIC 47 [V] MSW	L2-N	Measurement of the Phase - Neutral VRMS	RO	FLOAT32
40468	467	VRMS HARMONIC 47 [V] LSW			RO	

ADDRESS (4x)	ADDRESS OFFSET	REGISTER	PHASE	DESCRIPTION	W/R	TYPE
				of the i-th harmonic [V]		
40469	468	VRMS HARMONIC 47 [V] MSW	L3-N	Measurement of the Phase - Neutral VRMS of the i-th harmonic [V]	RO	FLOAT32
40470	469	VRMS HARMONIC 47 [V] LSW			RO	
40471	470	VRMS HARMONIC 48 [V] MSW	L1-N	Measurement of the Phase - Neutral VRMS of the i-th harmonic [V]	RO	FLOAT32
40472	471	VRMS HARMONIC 48 [V] LSW			RO	
40473	472	VRMS HARMONIC 48 [V] MSW	L2-N	Measurement of the Phase - Neutral VRMS of the i-th harmonic [V]	RO	FLOAT32
40474	473	VRMS HARMONIC 48 [V] LSW			RO	
40475	474	VRMS HARMONIC 48 [V] MSW	L3-N	Measurement of the Phase - Neutral VRMS of the i-th harmonic [V]	RO	FLOAT32
40476	475	VRMS HARMONIC 48 [V] LSW			RO	
40477	476	VRMS HARMONIC 49 [V] MSW	L1-N	Measurement of the Phase - Neutral VRMS of the i-th harmonic [V]	RO	FLOAT32
40478	477	VRMS HARMONIC 49 [V] LSW			RO	
40479	478	VRMS HARMONIC 49 [V] MSW	L2-N	Measurement of the Phase - Neutral VRMS of the i-th harmonic [V]	RO	FLOAT32
40480	479	VRMS HARMONIC 49 [V] LSW			RO	
40481	480	VRMS HARMONIC 49 [V] MSW	L3-N	Measurement of the Phase - Neutral VRMS of the i-th harmonic [V]	RO	FLOAT32
40482	481	VRMS HARMONIC 49 [V] LSW			RO	
40483	482	VRMS HARMONIC 50 [V] MSW	L1-N	Measurement of the Phase - Neutral VRMS of the i-th harmonic [V]	RO	FLOAT32
40484	483	VRMS HARMONIC 50 [V] LSW			RO	
40485	484	VRMS HARMONIC 50 [V] MSW	L2-N	Measurement of the Phase - Neutral VRMS of the i-th harmonic [V]	RO	FLOAT32
40486	485	VRMS HARMONIC 50 [V] LSW			RO	
40487	486	VRMS HARMONIC 50 [V] MSW	L3-N	Measurement of the Phase - Neutral VRMS of the i-th harmonic [V]	RO	FLOAT32
40488	487	VRMS HARMONIC 50 [V] LSW			RO	
40489	488	VRMS HARMONIC 51 [V] MSW	L1-N	Measurement of the Phase - Neutral VRMS of the i-th harmonic [V]	RO	FLOAT32
40490	489	VRMS HARMONIC 51 [V] LSW			RO	
40491	490	VRMS HARMONIC 51 [V] MSW	L2-N	Measurement of the Phase - Neutral VRMS of the i-th harmonic [V]	RO	FLOAT32
40492	491	VRMS HARMONIC 51 [V] LSW			RO	

ADDRESS (4x)	ADDRESS OFFSET	REGISTER	PHASE	DESCRIPTION	W/R	TYPE
40493	492	VRMS HARMONIC 51 [V] MSW	L3-N	Measurement of the Phase - Neutral VRMS of the i-th harmonic [V]	RO	FLOAT32
40494	493	VRMS HARMONIC 51 [V] LSW			RO	
40495	494	VRMS HARMONIC 52 [V] MSW	L1-N	Measurement of the Phase - Neutral VRMS of the i-th harmonic [V]	RO	FLOAT32
40496	495	VRMS HARMONIC 52 [V] LSW			RO	
40497	496	VRMS HARMONIC 52 [V] MSW	L2-N	Measurement of the Phase - Neutral VRMS of the i-th harmonic [V]	RO	FLOAT32
40498	497	VRMS HARMONIC 52 [V] LSW			RO	
40499	498	VRMS HARMONIC 52 [V] MSW	L3-N	Measurement of the Phase - Neutral VRMS of the i-th harmonic [V]	RO	FLOAT32
40500	499	VRMS HARMONIC 52 [V] LSW			RO	
40501	500	VRMS HARMONIC 53 [V] MSW	L1-N	Measurement of the Phase - Neutral VRMS of the i-th harmonic [V]	RO	FLOAT32
40502	501	VRMS HARMONIC 53 [V] LSW			RO	
40503	502	VRMS HARMONIC 53 [V] MSW	L2-N	Measurement of the Phase - Neutral VRMS of the i-th harmonic [V]	RO	FLOAT32
40504	503	VRMS HARMONIC 53 [V] LSW			RO	
40505	504	VRMS HARMONIC 53 [V] MSW	L3-N	Measurement of the Phase - Neutral VRMS of the i-th harmonic [V]	RO	FLOAT32
40506	505	VRMS HARMONIC 53 [V] LSW			RO	
40507	506	VRMS HARMONIC 54 [V] MSW	L1-N	Measurement of the Phase - Neutral VRMS of the i-th harmonic [V]	RO	FLOAT32
40508	507	VRMS HARMONIC 54 [V] LSW			RO	
40509	508	VRMS HARMONIC 54 [V] MSW	L2-N	Measurement of the Phase - Neutral VRMS of the i-th harmonic [V]	RO	FLOAT32
40510	509	VRMS HARMONIC 54 [V] LSW			RO	
40511	510	VRMS HARMONIC 54 [V] MSW	L3-N	Measurement of the Phase - Neutral VRMS of the i-th harmonic [V]	RO	FLOAT32
40512	511	VRMS HARMONIC 54 [V] LSW			RO	
40513	512	VRMS HARMONIC 55 [V] MSW	L1-N	Measurement of the Phase - Neutral VRMS of the i-th harmonic [V]	RO	FLOAT32
40514	513	VRMS HARMONIC 55 [V] LSW			RO	
40515	514	VRMS HARMONIC 55 [V] MSW	L2-N	Measurement of the Phase - Neutral VRMS of the i-th harmonic [V]	RO	FLOAT32
40516	515	VRMS HARMONIC 55 [V] LSW			RO	
40517	516	VRMS HARMONIC 55 [V] MSW	L3-N	Measurement of the Phase - Neutral VRMS	RO	FLOAT32
40518	517	VRMS HARMONIC 55 [V] LSW			RO	



ADDRESS (4x)	ADDRESS OFFSET	REGISTER	PHASE	DESCRIPTION	W/R	TYPE
				of the i-th harmonic [V]		
40519	518	IRMS FUNDAMENTAL [A] MSW	L1	Measurement of the phase IRMS fundamental alone [A]	RO	FLOAT32
40520	519	IRMS FUNDAMENTAL [A] LSW			RO	
40521	520	IRMS FUNDAMENTAL [A] MSW	L2	Measurement of the phase IRMS fundamental alone [A]	RO	FLOAT32
40522	521	IRMS FUNDAMENTAL [A] LSW			RO	
40523	522	IRMS FUNDAMENTAL [A] MSW	L3	Measurement of the phase IRMS fundamental alone [A]	RO	FLOAT32
40524	523	IRMS FUNDAMENTAL [A] LSW			RO	
40525	524	IRMS HARMONIC 2 [A] MSW	L1	Measurement of the phase IRMS of the i-th harmonic[A]	RO	FLOAT32
40526	525	IRMS HARMONIC 2 [A] LSW			RO	
40527	526	IRMS HARMONIC 2 [A] MSW	L2	Measurement of the phase IRMS of the i-th harmonic[A]	RO	FLOAT32
40528	527	IRMS HARMONIC 2 [A] LSW			RO	
40529	528	IRMS HARMONIC 2 [A] MSW	L3	Measurement of the phase IRMS of the i-th harmonic[A]	RO	FLOAT32
40530	529	IRMS HARMONIC 2 [A] LSW			RO	
40531	530	IRMS HARMONIC 3 [A] MSW	L1	Measurement of the phase IRMS of the i-th harmonic[A]	RO	FLOAT32
40532	531	IRMS HARMONIC 3 [A] LSW			RO	
40533	532	IRMS HARMONIC 3 [A] MSW	L2	Measurement of the phase IRMS of the i-th harmonic[A]	RO	FLOAT32
40534	533	IRMS HARMONIC 3 [A] LSW			RO	
40535	534	IRMS HARMONIC 3 [A] MSW	L3	Measurement of the phase IRMS of the i-th harmonic[A]	RO	FLOAT32
40536	535	IRMS HARMONIC 3 [A] LSW			RO	
40537	536	IRMS HARMONIC 4 [A] MSW	L1	Measurement of the phase IRMS of the i-th harmonic[A]	RO	FLOAT32
40538	537	IRMS HARMONIC 4 [A] LSW			RO	
40539	538	IRMS HARMONIC 4 [A] MSW	L2	Measurement of the phase IRMS of the i-th harmonic[A]	RO	FLOAT32
40540	539	IRMS HARMONIC 4 [A] LSW			RO	
40541	540	IRMS HARMONIC 4 [A] MSW	L3	Measurement of the phase IRMS of the i-th harmonic[A]	RO	FLOAT32
40542	541	IRMS HARMONIC 4 [A] LSW			RO	
40543	542	IRMS HARMONIC 5 [A] MSW	L1	Measurement of the phase IRMS of the i-th harmonic[A]	RO	FLOAT32
40544	543	IRMS HARMONIC 5 [A] LSW			RO	
40545	544	IRMS HARMONIC 5 [A] MSW	L2	Measurement of the phase IRMS of the i-th harmonic[A]	RO	FLOAT32
40546	545	IRMS HARMONIC 5 [A] LSW			RO	
40547	546	IRMS HARMONIC 5 [A] MSW	L3	Measurement of the phase IRMS of the i-th harmonic[A]	RO	FLOAT32
40548	547	IRMS HARMONIC 5 [A] LSW			RO	
40549	548	IRMS HARMONIC 6 [A] MSW	L1	Measurement of the phase IRMS of the i-th harmonic[A]	RO	FLOAT32
40550	549	IRMS HARMONIC 6 [A] LSW			RO	

ADDRESS (4x)	ADDRESS OFFSET	REGISTER	PHASE	DESCRIPTION	W/R	TYPE
40551	550	IRMS HARMONIC 6 [A] MSW	L2	Measurement of the phase IRMS of the i-th harmonic[A]	RO	FLOAT32
40552	551	IRMS HARMONIC 6 [A] LSW			RO	
40553	552	IRMS HARMONIC 6 [A] MSW	L3	Measurement of the phase IRMS of the i-th harmonic[A]	RO	FLOAT32
40554	553	IRMS HARMONIC 6 [A] LSW			RO	
40555	554	IRMS HARMONIC 7 [A] MSW	L1	Measurement of the phase IRMS of the i-th harmonic[A]	RO	FLOAT32
40556	555	IRMS HARMONIC 7 [A] LSW			RO	
40557	556	IRMS HARMONIC 7 [A] MSW	L2	Measurement of the phase IRMS of the i-th harmonic[A]	RO	FLOAT32
40558	557	IRMS HARMONIC 7 [A] LSW			RO	
40559	558	IRMS HARMONIC 7 [A] MSW	L3	Measurement of the phase IRMS of the i-th harmonic[A]	RO	FLOAT32
40560	559	IRMS HARMONIC 7 [A] LSW			RO	
40561	560	IRMS HARMONIC 8 [A] MSW	L1	Measurement of the phase IRMS of the i-th harmonic[A]	RO	FLOAT32
40562	561	IRMS HARMONIC 8 [A] LSW			RO	
40563	562	IRMS HARMONIC 8 [A] MSW	L2	Measurement of the phase IRMS of the i-th harmonic[A]	RO	FLOAT32
40564	563	IRMS HARMONIC 8 [A] LSW			RO	
40565	564	IRMS HARMONIC 8 [A] MSW	L3	Measurement of the phase IRMS of the i-th harmonic[A]	RO	FLOAT32
40566	565	IRMS HARMONIC 8 [A] LSW			RO	
40567	566	IRMS HARMONIC 9 [A] MSW	L1	Measurement of the phase IRMS of the i-th harmonic[A]	RO	FLOAT32
40568	567	IRMS HARMONIC 9 [A] LSW			RO	
40569	568	IRMS HARMONIC 9 [A] MSW	L2	Measurement of the phase IRMS of the i-th harmonic[A]	RO	FLOAT32
40570	569	IRMS HARMONIC 9 [A] LSW			RO	
40571	570	IRMS HARMONIC 9 [A] MSW	L3	Measurement of the phase IRMS of the i-th harmonic[A]	RO	FLOAT32
40572	571	IRMS HARMONIC 9 [A] LSW			RO	
40573	572	IRMS HARMONIC 10 [A] MSW	L1	Measurement of the phase IRMS of the i-th harmonic[A]	RO	FLOAT32
40574	573	IRMS HARMONIC 10 [A] LSW			RO	
40575	574	IRMS HARMONIC 10 [A] MSW	L2	Measurement of the phase IRMS of the i-th harmonic[A]	RO	FLOAT32
40576	575	IRMS HARMONIC 10 [A] LSW			RO	
40577	576	IRMS HARMONIC 10 [A] MSW	L3	Measurement of the phase IRMS of the i-th harmonic[A]	RO	FLOAT32
40578	577	IRMS HARMONIC 10 [A] LSW			RO	
40579	578	IRMS HARMONIC 11 [A] MSW	L1	Measurement of the phase IRMS of the i-th harmonic[A]	RO	FLOAT32
40580	579	IRMS HARMONIC 11 [A] LSW			RO	
40581	580	IRMS HARMONIC 11 [A] MSW	L2	Measurement of the phase IRMS of the i-th harmonic[A]	RO	FLOAT32
40582	581	IRMS HARMONIC 11 [A] LSW			RO	
40583	582	IRMS HARMONIC 11 [A] MSW	L3		RO	FLOAT32

ADDRESS (4x)	ADDRESS OFFSET	REGISTER	PHASE	DESCRIPTION	W/R	TYPE
40584	583	IRMS HARMONIC 11 [A] LSW		Measurement of the phase IRMS of the i-th harmonic[A]	RO	
40585	584	IRMS HARMONIC 12 [A] MSW	L1	Measurement of the phase IRMS of the i-th harmonic[A]	RO	FLOAT32
40586	585	IRMS HARMONIC 12 [A] LSW			RO	
40587	586	IRMS HARMONIC 12 [A] MSW	L2	Measurement of the phase IRMS of the i-th harmonic[A]	RO	FLOAT32
40588	587	IRMS HARMONIC 12 [A] LSW			RO	
40589	588	IRMS HARMONIC 12 [A] MSW	L3	Measurement of the phase IRMS of the i-th harmonic[A]	RO	FLOAT32
40590	589	IRMS HARMONIC 12 [A] LSW			RO	
40591	590	IRMS HARMONIC 13 [A] MSW	L1	Measurement of the phase IRMS of the i-th harmonic[A]	RO	FLOAT32
40592	591	IRMS HARMONIC 13 [A] LSW			RO	
40593	592	IRMS HARMONIC 13 [A] MSW	L2	Measurement of the phase IRMS of the i-th harmonic[A]	RO	FLOAT32
40594	593	IRMS HARMONIC 13 [A] LSW			RO	
40595	594	IRMS HARMONIC 13 [A] MSW	L3	Measurement of the phase IRMS of the i-th harmonic[A]	RO	FLOAT32
40596	595	IRMS HARMONIC 13 [A] LSW			RO	
40597	596	IRMS HARMONIC 14 [A] MSW	L1	Measurement of the phase IRMS of the i-th harmonic[A]	RO	FLOAT32
40598	597	IRMS HARMONIC 14 [A] LSW			RO	
40599	598	IRMS HARMONIC 14 [A] MSW	L2	Measurement of the phase IRMS of the i-th harmonic[A]	RO	FLOAT32
40600	599	IRMS HARMONIC 14 [A] LSW			RO	
40601	600	IRMS HARMONIC 14 [A] MSW	L3	Measurement of the phase IRMS of the i-th harmonic[A]	RO	FLOAT32
40602	601	IRMS HARMONIC 14 [A] LSW			RO	
40603	602	IRMS HARMONIC 15 [A] MSW	L1	Measurement of the phase IRMS of the i-th harmonic[A]	RO	FLOAT32
40604	603	IRMS HARMONIC 15 [A] LSW			RO	
40605	604	IRMS HARMONIC 15 [A] MSW	L2	Measurement of the phase IRMS of the i-th harmonic[A]	RO	FLOAT32
40606	605	IRMS HARMONIC 15 [A] LSW			RO	
40607	606	IRMS HARMONIC 15 [A] MSW	L3	Measurement of the phase IRMS of the i-th harmonic[A]	RO	FLOAT32
40608	607	IRMS HARMONIC 15 [A] LSW			RO	
40609	608	IRMS HARMONIC 16 [A] MSW	L1	Measurement of the phase IRMS of the i-th harmonic[A]	RO	FLOAT32
40610	609	IRMS HARMONIC 16 [A] LSW			RO	
40611	610	IRMS HARMONIC 16 [A] MSW	L2	Measurement of the phase IRMS of the i-th harmonic[A]	RO	FLOAT32
40612	611	IRMS HARMONIC 16 [A] LSW			RO	
40613	612	IRMS HARMONIC 16 [A] MSW	L3	Measurement of the phase IRMS of the i-th harmonic[A]	RO	FLOAT32
40614	613	IRMS HARMONIC 16 [A] LSW			RO	
40615	614	IRMS HARMONIC 17 [A] MSW	L1		RO	FLOAT32

ADDRESS (4x)	ADDRESS OFFSET	REGISTER	PHASE	DESCRIPTION	W/R	TYPE
40616	615	IRMS HARMONIC 17 [A] LSW		Measurement of the phase IRMS of the i-th harmonic[A]	RO	
40617	616	IRMS HARMONIC 17 [A] MSW	L2	Measurement of the phase IRMS of the i-th harmonic[A]	RO	FLOAT32
40618	617	IRMS HARMONIC 17 [A] LSW			RO	
40619	618	IRMS HARMONIC 17 [A] MSW	L3	Measurement of the phase IRMS of the i-th harmonic[A]	RO	FLOAT32
40620	619	IRMS HARMONIC 17 [A] LSW			RO	
40621	620	IRMS HARMONIC 18 [A] MSW	L1	Measurement of the phase IRMS of the i-th harmonic[A]	RO	FLOAT32
40622	621	IRMS HARMONIC 18 [A] LSW			RO	
40623	622	IRMS HARMONIC 18 [A] MSW	L2	Measurement of the phase IRMS of the i-th harmonic[A]	RO	FLOAT32
40624	623	IRMS HARMONIC 18 [A] LSW			RO	
40625	624	IRMS HARMONIC 18 [A] MSW	L3	Measurement of the phase IRMS of the i-th harmonic[A]	RO	FLOAT32
40626	625	IRMS HARMONIC 18 [A] LSW			RO	
40627	626	IRMS HARMONIC 19 [A] MSW	L1	Measurement of the phase IRMS of the i-th harmonic[A]	RO	FLOAT32
40628	627	IRMS HARMONIC 19 [A] LSW			RO	
40629	628	IRMS HARMONIC 19 [A] MSW	L2	Measurement of the phase IRMS of the i-th harmonic[A]	RO	FLOAT32
40630	629	IRMS HARMONIC 19 [A] LSW			RO	
40631	630	IRMS HARMONIC 19 [A] MSW	L3	Measurement of the phase IRMS of the i-th harmonic[A]	RO	FLOAT32
40632	631	IRMS HARMONIC 19 [A] LSW			RO	
40633	632	IRMS HARMONIC 20 [A] MSW	L1	Measurement of the phase IRMS of the i-th harmonic[A]	RO	FLOAT32
40634	633	IRMS HARMONIC 20 [A] LSW			RO	
40635	634	IRMS HARMONIC 20 [A] MSW	L2	Measurement of the phase IRMS of the i-th harmonic[A]	RO	FLOAT32
40636	635	IRMS HARMONIC 20 [A] LSW			RO	
40637	636	IRMS HARMONIC 20 [A] MSW	L3	Measurement of the phase IRMS of the i-th harmonic[A]	RO	FLOAT32
40638	637	IRMS HARMONIC 20 [A] LSW			RO	
40639	638	IRMS HARMONIC 21 [A] MSW	L1	Measurement of the phase IRMS of the i-th harmonic[A]	RO	FLOAT32
40640	639	IRMS HARMONIC 21 [A] LSW			RO	
40641	640	IRMS HARMONIC 21 [A] MSW	L2	Measurement of the phase IRMS of the i-th harmonic[A]	RO	FLOAT32
40642	641	IRMS HARMONIC 21 [A] LSW			RO	
40643	642	IRMS HARMONIC 21 [A] MSW	L3	Measurement of the phase IRMS of the i-th harmonic[A]	RO	FLOAT32
40644	643	IRMS HARMONIC 21 [A] LSW			RO	
40645	644	IRMS HARMONIC 22 [A] MSW	L1	Measurement of the phase IRMS of the i-th harmonic[A]	RO	FLOAT32
40646	645	IRMS HARMONIC 22 [A] LSW			RO	
40647	646	IRMS HARMONIC 22 [A] MSW	L2		RO	FLOAT32

ADDRESS (4x)	ADDRESS OFFSET	REGISTER	PHASE	DESCRIPTION	W/R	TYPE
40648	647	IRMS HARMONIC 22 [A] LSW		Measurement of the phase IRMS of the i-th harmonic[A]	RO	
40649	648	IRMS HARMONIC 22 [A] MSW	L3	Measurement of the phase IRMS of the i-th harmonic[A]	RO	FLOAT32
40650	649	IRMS HARMONIC 22 [A] LSW			RO	
40651	650	IRMS HARMONIC 23 [A] MSW	L1	Measurement of the phase IRMS of the i-th harmonic[A]	RO	FLOAT32
40652	651	IRMS HARMONIC 23 [A] LSW			RO	
40653	652	IRMS HARMONIC 23 [A] MSW	L2	Measurement of the phase IRMS of the i-th harmonic[A]	RO	FLOAT32
40654	653	IRMS HARMONIC 23 [A] LSW			RO	
40655	654	IRMS HARMONIC 23 [A] MSW	L3	Measurement of the phase IRMS of the i-th harmonic[A]	RO	FLOAT32
40656	655	IRMS HARMONIC 23 [A] LSW			RO	
40657	656	IRMS HARMONIC 24 [A] MSW	L1	Measurement of the phase IRMS of the i-th harmonic[A]	RO	FLOAT32
40658	657	IRMS HARMONIC 24 [A] LSW			RO	
40659	658	IRMS HARMONIC 24 [A] MSW	L2	Measurement of the phase IRMS of the i-th harmonic[A]	RO	FLOAT32
40660	659	IRMS HARMONIC 24 [A] LSW			RO	
40661	660	IRMS HARMONIC 24 [A] MSW	L3	Measurement of the phase IRMS of the i-th harmonic[A]	RO	FLOAT32
40662	661	IRMS HARMONIC 24 [A] LSW			RO	
40663	662	IRMS HARMONIC 25 [A] MSW	L1	Measurement of the phase IRMS of the i-th harmonic[A]	RO	FLOAT32
40664	663	IRMS HARMONIC 25 [A] LSW			RO	
40665	664	IRMS HARMONIC 25 [A] MSW	L2	Measurement of the phase IRMS of the i-th harmonic[A]	RO	FLOAT32
40666	665	IRMS HARMONIC 25 [A] LSW			RO	
40667	666	IRMS HARMONIC 25 [A] MSW	L3	Measurement of the phase IRMS of the i-th harmonic[A]	RO	FLOAT32
40668	667	IRMS HARMONIC 25 [A] LSW			RO	
40669	668	IRMS HARMONIC 26 [A] MSW	L1	Measurement of the phase IRMS of the i-th harmonic[A]	RO	FLOAT32
40670	669	IRMS HARMONIC 26 [A] LSW			RO	
40671	670	IRMS HARMONIC 26 [A] MSW	L2	Measurement of the phase IRMS of the i-th harmonic[A]	RO	FLOAT32
40672	671	IRMS HARMONIC 26 [A] LSW			RO	
40673	672	IRMS HARMONIC 26 [A] MSW	L3	Measurement of the phase IRMS of the i-th harmonic[A]	RO	FLOAT32
40674	673	IRMS HARMONIC 26 [A] LSW			RO	
40675	674	IRMS HARMONIC 27 [A] MSW	L1	Measurement of the phase IRMS of the i-th harmonic[A]	RO	FLOAT32
40676	675	IRMS HARMONIC 27 [A] LSW			RO	
40677	676	IRMS HARMONIC 27 [A] MSW	L2	Measurement of the phase IRMS of the i-th harmonic[A]	RO	FLOAT32
40678	677	IRMS HARMONIC 27 [A] LSW			RO	
40679	678	IRMS HARMONIC 27 [A] MSW	L3		RO	FLOAT32

ADDRESS (4x)	ADDRESS OFFSET	REGISTER	PHASE	DESCRIPTION	W/R	TYPE
40680	679	IRMS HARMONIC 27 [A] LSW		Measurement of the phase IRMS of the i-th harmonic[A]	RO	
40681	680	IRMS HARMONIC 28 [A] MSW	L1	Measurement of the phase IRMS of the i-th harmonic[A]	RO	FLOAT32
40682	681	IRMS HARMONIC 28 [A] LSW			RO	
40683	682	IRMS HARMONIC 28 [A] MSW	L2	Measurement of the phase IRMS of the i-th harmonic[A]	RO	FLOAT32
40684	683	IRMS HARMONIC 28 [A] LSW			RO	
40685	684	IRMS HARMONIC 28 [A] MSW	L3	Measurement of the phase IRMS of the i-th harmonic[A]	RO	FLOAT32
40686	685	IRMS HARMONIC 28 [A] LSW			RO	
40687	686	IRMS HARMONIC 29 [A] MSW	L1	Measurement of the phase IRMS of the i-th harmonic[A]	RO	FLOAT32
40688	687	IRMS HARMONIC 29 [A] LSW			RO	
40689	688	IRMS HARMONIC 29 [A] MSW	L2	Measurement of the phase IRMS of the i-th harmonic[A]	RO	FLOAT32
40690	689	IRMS HARMONIC 29 [A] LSW			RO	
40691	690	IRMS HARMONIC 29 [A] MSW	L3	Measurement of the phase IRMS of the i-th harmonic[A]	RO	FLOAT32
40692	691	IRMS HARMONIC 29 [A] LSW			RO	
40693	692	IRMS HARMONIC 30 [A] MSW	L1	Measurement of the phase IRMS of the i-th harmonic[A]	RO	FLOAT32
40694	693	IRMS HARMONIC 30 [A] LSW			RO	
40695	694	IRMS HARMONIC 30 [A] MSW	L2	Measurement of the phase IRMS of the i-th harmonic[A]	RO	FLOAT32
40696	695	IRMS HARMONIC 30 [A] LSW			RO	
40697	696	IRMS HARMONIC 30 [A] MSW	L3	Measurement of the phase IRMS of the i-th harmonic[A]	RO	FLOAT32
40698	697	IRMS HARMONIC 30 [A] LSW			RO	
40699	698	IRMS HARMONIC 31 [A] MSW	L1	Measurement of the phase IRMS of the i-th harmonic[A]	RO	FLOAT32
40700	699	IRMS HARMONIC 31 [A] LSW			RO	
40701	700	IRMS HARMONIC 31 [A] MSW	L2	Measurement of the phase IRMS of the i-th harmonic[A]	RO	FLOAT32
40702	701	IRMS HARMONIC 31 [A] LSW			RO	
40703	702	IRMS HARMONIC 31 [A] MSW	L3	Measurement of the phase IRMS of the i-th harmonic[A]	RO	FLOAT32
40704	703	IRMS HARMONIC 31 [A] LSW			RO	
40705	704	IRMS HARMONIC 32 [A] MSW	L1	Measurement of the phase IRMS of the i-th harmonic[A]	RO	FLOAT32
40706	705	IRMS HARMONIC 32 [A] LSW			RO	
40707	706	IRMS HARMONIC 32 [A] MSW	L2	Measurement of the phase IRMS of the i-th harmonic[A]	RO	FLOAT32
40708	707	IRMS HARMONIC 32 [A] LSW			RO	
40709	708	IRMS HARMONIC 32 [A] MSW	L3	Measurement of the phase IRMS of the i-th harmonic[A]	RO	FLOAT32
40710	709	IRMS HARMONIC 32 [A] LSW			RO	
40711	710	IRMS HARMONIC 33 [A] MSW	L1		RO	FLOAT32

ADDRESS (4x)	ADDRESS OFFSET	REGISTER	PHASE	DESCRIPTION	W/R	TYPE
40712	711	IRMS HARMONIC 33 [A] LSW		Measurement of the phase IRMS of the i-th harmonic[A]	RO	
40713	712	IRMS HARMONIC 33 [A] MSW	L2	Measurement of the phase IRMS of the i-th harmonic[A]	RO	FLOAT32
40714	713	IRMS HARMONIC 33 [A] LSW			RO	
40715	714	IRMS HARMONIC 33 [A] MSW	L3	Measurement of the phase IRMS of the i-th harmonic[A]	RO	FLOAT32
40716	715	IRMS HARMONIC 33 [A] LSW			RO	
40717	716	IRMS HARMONIC 34 [A] MSW	L1	Measurement of the phase IRMS of the i-th harmonic[A]	RO	FLOAT32
40718	717	IRMS HARMONIC 34 [A] LSW			RO	
40719	718	IRMS HARMONIC 34 [A] MSW	L2	Measurement of the phase IRMS of the i-th harmonic[A]	RO	FLOAT32
40720	719	IRMS HARMONIC 34 [A] LSW			RO	
40721	720	IRMS HARMONIC 34 [A] MSW	L3	Measurement of the phase IRMS of the i-th harmonic[A]	RO	FLOAT32
40722	721	IRMS HARMONIC 34 [A] LSW			RO	
40723	722	IRMS HARMONIC 35 [A] MSW	L1	Measurement of the phase IRMS of the i-th harmonic[A]	RO	FLOAT32
40724	723	IRMS HARMONIC 35 [A] LSW			RO	
40725	724	IRMS HARMONIC 35 [A] MSW	L2	Measurement of the phase IRMS of the i-th harmonic[A]	RO	FLOAT32
40726	725	IRMS HARMONIC 35 [A] LSW			RO	
40727	726	IRMS HARMONIC 35 [A] MSW	L3	Measurement of the phase IRMS of the i-th harmonic[A]	RO	FLOAT32
40728	727	IRMS HARMONIC 35 [A] LSW			RO	
40729	728	IRMS HARMONIC 36 [A] MSW	L1	Measurement of the phase IRMS of the i-th harmonic[A]	RO	FLOAT32
40730	729	IRMS HARMONIC 36 [A] LSW			RO	
40731	730	IRMS HARMONIC 36 [A] MSW	L2	Measurement of the phase IRMS of the i-th harmonic[A]	RO	FLOAT32
40732	731	IRMS HARMONIC 36 [A] LSW			RO	
40733	732	IRMS HARMONIC 36 [A] MSW	L3	Measurement of the phase IRMS of the i-th harmonic[A]	RO	FLOAT32
40734	733	IRMS HARMONIC 36 [A] LSW			RO	
40735	734	IRMS HARMONIC 37 [A] MSW	L1	Measurement of the phase IRMS of the i-th harmonic[A]	RO	FLOAT32
40736	735	IRMS HARMONIC 37 [A] LSW			RO	
40737	736	IRMS HARMONIC 37 [A] MSW	L2	Measurement of the phase IRMS of the i-th harmonic[A]	RO	FLOAT32
40738	737	IRMS HARMONIC 37 [A] LSW			RO	
40739	738	IRMS HARMONIC 37 [A] MSW	L3	Measurement of the phase IRMS of the i-th harmonic[A]	RO	FLOAT32
40740	739	IRMS HARMONIC 37 [A] LSW			RO	
40741	740	IRMS HARMONIC 38 [A] MSW	L1	Measurement of the phase IRMS of the i-th harmonic[A]	RO	FLOAT32
40742	741	IRMS HARMONIC 38 [A] LSW			RO	
40743	742	IRMS HARMONIC 38 [A] MSW	L2		RO	FLOAT32

ADDRESS (4x)	ADDRESS OFFSET	REGISTER	PHASE	DESCRIPTION	W/R	TYPE
40744	743	IRMS HARMONIC 38 [A] LSW		Measurement of the phase IRMS of the i-th harmonic[A]	RO	
40745	744	IRMS HARMONIC 38 [A] MSW	L3	Measurement of the phase IRMS of the i-th harmonic[A]	RO	FLOAT32
40746	745	IRMS HARMONIC 38 [A] LSW			RO	
40747	746	IRMS HARMONIC 39 [A] MSW	L1	Measurement of the phase IRMS of the i-th harmonic[A]	RO	FLOAT32
40748	747	IRMS HARMONIC 39 [A] LSW			RO	
40749	748	IRMS HARMONIC 39 [A] MSW	L2	Measurement of the phase IRMS of the i-th harmonic[A]	RO	FLOAT32
40750	749	IRMS HARMONIC 39 [A] LSW			RO	
40751	750	IRMS HARMONIC 39 [A] MSW	L3	Measurement of the phase IRMS of the i-th harmonic[A]	RO	FLOAT32
40752	751	IRMS HARMONIC 39 [A] LSW			RO	
40753	752	IRMS HARMONIC 40 [A] MSW	L1	Measurement of the phase IRMS of the i-th harmonic[A]	RO	FLOAT32
40754	753	IRMS HARMONIC 40 [A] LSW			RO	
40755	754	IRMS HARMONIC 40 [A] MSW	L2	Measurement of the phase IRMS of the i-th harmonic[A]	RO	FLOAT32
40756	755	IRMS HARMONIC 40 [A] LSW			RO	
40757	756	IRMS HARMONIC 40 [A] MSW	L3	Measurement of the phase IRMS of the i-th harmonic[A]	RO	FLOAT32
40758	757	IRMS HARMONIC 40 [A] LSW			RO	
40759	758	IRMS HARMONIC 41 [A] MSW	L1	Measurement of the phase IRMS of the i-th harmonic[A]	RO	FLOAT32
40760	759	IRMS HARMONIC 41 [A] LSW			RO	
40761	760	IRMS HARMONIC 41 [A] MSW	L2	Measurement of the phase IRMS of the i-th harmonic[A]	RO	FLOAT32
40762	761	IRMS HARMONIC 41 [A] LSW			RO	
40763	762	IRMS HARMONIC 41 [A] MSW	L3	Measurement of the phase IRMS of the i-th harmonic[A]	RO	FLOAT32
40764	763	IRMS HARMONIC 41 [A] LSW			RO	
40765	764	IRMS HARMONIC 42 [A] MSW	L1	Measurement of the phase IRMS of the i-th harmonic[A]	RO	FLOAT32
40766	765	IRMS HARMONIC 42 [A] LSW			RO	
40767	766	IRMS HARMONIC 42 [A] MSW	L2	Measurement of the phase IRMS of the i-th harmonic[A]	RO	FLOAT32
40768	767	IRMS HARMONIC 42 [A] LSW			RO	
40769	768	IRMS HARMONIC 42 [A] MSW	L3	Measurement of the phase IRMS of the i-th harmonic[A]	RO	FLOAT32
40770	769	IRMS HARMONIC 42 [A] LSW			RO	
40771	770	IRMS HARMONIC 43 [A] MSW	L1	Measurement of the phase IRMS of the i-th harmonic[A]	RO	FLOAT32
40772	771	IRMS HARMONIC 43 [A] LSW			RO	
40773	772	IRMS HARMONIC 43 [A] MSW	L2	Measurement of the phase IRMS of the i-th harmonic[A]	RO	FLOAT32
40774	773	IRMS HARMONIC 43 [A] LSW			RO	
40775	774	IRMS HARMONIC 43 [A] MSW	L3		RO	FLOAT32



ADDRESS (4x)	ADDRESS OFFSET	REGISTER	PHASE	DESCRIPTION	W/R	TYPE
40776	775	IRMS HARMONIC 43 [A] LSW		Measurement of the phase IRMS of the i-th harmonic[A]	RO	
40777	776	IRMS HARMONIC 44 [A] MSW	L1	Measurement of the phase IRMS of the i-th harmonic[A]	RO	FLOAT32
40778	777	IRMS HARMONIC 44 [A] LSW			RO	
40779	778	IRMS HARMONIC 44 [A] MSW	L2	Measurement of the phase IRMS of the i-th harmonic[A]	RO	FLOAT32
40780	779	IRMS HARMONIC 44 [A] LSW			RO	
40781	780	IRMS HARMONIC 44 [A] MSW	L3	Measurement of the phase IRMS of the i-th harmonic[A]	RO	FLOAT32
40782	781	IRMS HARMONIC 44 [A] LSW			RO	
40783	782	IRMS HARMONIC 45 [A] MSW	L1	Measurement of the phase IRMS of the i-th harmonic[A]	RO	FLOAT32
40784	783	IRMS HARMONIC 45 [A] LSW			RO	
40785	784	IRMS HARMONIC 45 [A] MSW	L2	Measurement of the phase IRMS of the i-th harmonic[A]	RO	FLOAT32
40786	785	IRMS HARMONIC 45 [A] LSW			RO	
40787	786	IRMS HARMONIC 45 [A] MSW	L3	Measurement of the phase IRMS of the i-th harmonic[A]	RO	FLOAT32
40788	787	IRMS HARMONIC 45 [A] LSW			RO	
40789	788	IRMS HARMONIC 46 [A] MSW	L1	Measurement of the phase IRMS of the i-th harmonic[A]	RO	FLOAT32
40790	789	IRMS HARMONIC 46 [A] LSW			RO	
40791	790	IRMS HARMONIC 46 [A] MSW	L2	Measurement of the phase IRMS of the i-th harmonic[A]	RO	FLOAT32
40792	791	IRMS HARMONIC 46 [A] LSW			RO	
40793	792	IRMS HARMONIC 46 [A] MSW	L3	Measurement of the phase IRMS of the i-th harmonic[A]	RO	FLOAT32
40794	793	IRMS HARMONIC 46 [A] LSW			RO	
40795	794	IRMS HARMONIC 47 [A] MSW	L1	Measurement of the phase IRMS of the i-th harmonic[A]	RO	FLOAT32
40796	795	IRMS HARMONIC 47 [A] LSW			RO	
40797	796	IRMS HARMONIC 47 [A] MSW	L2	Measurement of the phase IRMS of the i-th harmonic[A]	RO	FLOAT32
40798	797	IRMS HARMONIC 47 [A] LSW			RO	
40799	798	IRMS HARMONIC 47 [A] MSW	L3	Measurement of the phase IRMS of the i-th harmonic[A]	RO	FLOAT32
40800	799	IRMS HARMONIC 47 [A] LSW			RO	
40801	800	IRMS HARMONIC 48 [A] MSW	L1	Measurement of the phase IRMS of the i-th harmonic[A]	RO	FLOAT32
40802	801	IRMS HARMONIC 48 [A] LSW			RO	
40803	802	IRMS HARMONIC 48 [A] MSW	L2	Measurement of the phase IRMS of the i-th harmonic[A]	RO	FLOAT32
40804	803	IRMS HARMONIC 48 [A] LSW			RO	
40805	804	IRMS HARMONIC 48 [A] MSW	L3	Measurement of the phase IRMS of the i-th harmonic[A]	RO	FLOAT32
40806	805	IRMS HARMONIC 48 [A] LSW			RO	
40807	806	IRMS HARMONIC 49 [A] MSW	L1		RO	FLOAT32

ADDRESS (4x)	ADDRESS OFFSET	REGISTER	PHASE	DESCRIPTION	W/R	TYPE
40808	807	IRMS HARMONIC 49 [A] LSW		Measurement of the phase IRMS of the i-th harmonic[A]	RO	
40809	808	IRMS HARMONIC 49 [A] MSW	L2	Measurement of the phase IRMS of the i-th harmonic[A]	RO	FLOAT32
40810	809	IRMS HARMONIC 49 [A] LSW			RO	
40811	810	IRMS HARMONIC 49 [A] MSW	L3	Measurement of the phase IRMS of the i-th harmonic[A]	RO	FLOAT32
40812	811	IRMS HARMONIC 49 [A] LSW			RO	
40813	812	IRMS HARMONIC 50 [A] MSW	L1	Measurement of the phase IRMS of the i-th harmonic[A]	RO	FLOAT32
40814	813	IRMS HARMONIC 50 [A] LSW			RO	
40815	814	IRMS HARMONIC 50 [A] MSW	L2	Measurement of the phase IRMS of the i-th harmonic[A]	RO	FLOAT32
40816	815	IRMS HARMONIC 50 [A] LSW			RO	
40817	816	IRMS HARMONIC 50 [A] MSW	L3	Measurement of the phase IRMS of the i-th harmonic[A]	RO	FLOAT32
40818	817	IRMS HARMONIC 50 [A] LSW			RO	
40819	818	IRMS HARMONIC 51 [A] MSW	L1	Measurement of the phase IRMS of the i-th harmonic[A]	RO	FLOAT32
40820	819	IRMS HARMONIC 51 [A] LSW			RO	
40821	820	IRMS HARMONIC 51 [A] MSW	L2	Measurement of the phase IRMS of the i-th harmonic[A]	RO	FLOAT32
40822	821	IRMS HARMONIC 51 [A] LSW			RO	
40823	822	IRMS HARMONIC 51 [A] MSW	L3	Measurement of the phase IRMS of the i-th harmonic[A]	RO	FLOAT32
40824	823	IRMS HARMONIC 51 [A] LSW			RO	
40825	824	IRMS HARMONIC 52 [A] MSW	L1	Measurement of the phase IRMS of the i-th harmonic[A]	RO	FLOAT32
40826	825	IRMS HARMONIC 52 [A] LSW			RO	
40827	826	IRMS HARMONIC 52 [A] MSW	L2	Measurement of the phase IRMS of the i-th harmonic[A]	RO	FLOAT32
40828	827	IRMS HARMONIC 52 [A] LSW			RO	
40829	828	IRMS HARMONIC 52 [A] MSW	L3	Measurement of the phase IRMS of the i-th harmonic[A]	RO	FLOAT32
40830	829	IRMS HARMONIC 52 [A] LSW			RO	
40831	830	IRMS HARMONIC 53 [A] MSW	L1	Measurement of the phase IRMS of the i-th harmonic[A]	RO	FLOAT32
40832	831	IRMS HARMONIC 53 [A] LSW			RO	
40833	832	IRMS HARMONIC 53 [A] MSW	L2	Measurement of the phase IRMS of the i-th harmonic[A]	RO	FLOAT32
40834	833	IRMS HARMONIC 53 [A] LSW			RO	
40835	834	IRMS HARMONIC 53 [A] MSW	L3	Measurement of the phase IRMS of the i-th harmonic[A]	RO	FLOAT32
40836	835	IRMS HARMONIC 53 [A] LSW			RO	
40837	836	IRMS HARMONIC 54 [A] MSW	L1	Measurement of the phase IRMS of the i-th harmonic[A]	RO	FLOAT32
40838	837	IRMS HARMONIC 54 [A] LSW			RO	
40839	838	IRMS HARMONIC 54 [A] MSW	L2		RO	FLOAT32

ADDRESS (4x)	ADDRESS OFFSET	REGISTER	PHASE	DESCRIPTION	W/R	TYPE
40840	839	IRMS HARMONIC 54 [A] LSW		Measurement of the phase IRMS of the i-th harmonic[A]	RO	
40841	840	IRMS HARMONIC 54 [A] MSW	L3	Measurement of the phase IRMS of the i-th harmonic[A]	RO	FLOAT32
40842	841	IRMS HARMONIC 54 [A] LSW			RO	
40843	842	IRMS HARMONIC 55 [A] MSW	L1	Measurement of the phase IRMS of the i-th harmonic[A]	RO	FLOAT32
40844	843	IRMS HARMONIC 55 [A] LSW			RO	
40845	844	IRMS HARMONIC 55 [A] MSW	L2	Measurement of the phase IRMS of the i-th harmonic[A]	RO	FLOAT32
40846	845	IRMS HARMONIC 55 [A] LSW			RO	
40847	846	IRMS HARMONIC 55 [A] MSW	L3	Measurement of the phase IRMS of the i-th harmonic[A]	RO	FLOAT32
40848	847	IRMS HARMONIC 55 [A] LSW			RO	
40849	848	VRMS HARMONIC 2 [%] MSW	L1-N	Measurement of the Phase - Neutral voltage of the i-th harmonic in comparison with the fundamental [%]	RO	FLOAT32
40850	849	VRMS HARMONIC 2 [%] LSW			RO	
40851	850	VRMS HARMONIC 2 [%] MSW	L2-N	Measurement of the Phase - Neutral voltage of the i-th harmonic in comparison with the fundamental [%]	RO	FLOAT32
40852	851	VRMS HARMONIC 2 [%] LSW			RO	
40853	852	VRMS HARMONIC 2 [%] MSW	L3-N	Measurement of the Phase - Neutral voltage of the i-th harmonic in comparison with the fundamental [%]	RO	FLOAT32
40854	853	VRMS HARMONIC 2 [%] LSW			RO	
40855	854	VRMS HARMONIC 3 [%] MSW	L1-N	Measurement of the Phase - Neutral voltage of the i-th harmonic in comparison with the fundamental [%]	RO	FLOAT32
40856	855	VRMS HARMONIC 3 [%] LSW			RO	
40857	856	VRMS HARMONIC 3 [%] MSW	L2-N	Measurement of the Phase - Neutral voltage of the i-th harmonic in comparison with the fundamental [%]	RO	FLOAT32
40858	857	VRMS HARMONIC 3 [%] LSW			RO	
40859	858	VRMS HARMONIC 3 [%] MSW	L3-N	Measurement of the Phase - Neutral voltage of the i-th harmonic in comparison with the fundamental [%]	RO	FLOAT32
40860	859	VRMS HARMONIC 3 [%] LSW			RO	
40861	860	VRMS HARMONIC 4 [%] MSW	L1-N		RO	FLOAT32

ADDRESS (4x)	ADDRESS OFFSET	REGISTER	PHASE	DESCRIPTION	W/R	TYPE
40862	861	VRMS HARMONIC 4 [%] LSW		Measurement of the Phase - Neutral voltage of the i-th harmonic in comparison with the fundamental [%]	RO	
40863	862	VRMS HARMONIC 4 [%] MSW		Measurement of the Phase - Neutral voltage of the i-th harmonic in comparison with the fundamental [%]	RO	FLOAT32
40864	863	VRMS HARMONIC 4 [%] LSW	L2-N		RO	
40865	864	VRMS HARMONIC 4 [%] MSW		Measurement of the Phase - Neutral voltage of the i-th harmonic in comparison with the fundamental [%]	RO	FLOAT32
40866	865	VRMS HARMONIC 4 [%] LSW	L3-N		RO	
40867	866	VRMS HARMONIC 5 [%] MSW		Measurement of the Phase - Neutral voltage of the i-th harmonic in comparison with the fundamental [%]	RO	FLOAT32
40868	867	VRMS HARMONIC 5 [%] LSW	L1-N		RO	
40869	868	VRMS HARMONIC 5 [%] MSW		Measurement of the Phase - Neutral voltage of the i-th harmonic in comparison with the fundamental [%]	RO	FLOAT32
40870	869	VRMS HARMONIC 5 [%] LSW	L2-N		RO	
40871	870	VRMS HARMONIC 5 [%] MSW		Measurement of the Phase - Neutral voltage of the i-th harmonic in comparison with the fundamental [%]	RO	FLOAT32
40872	871	VRMS HARMONIC 5 [%] LSW	L3-N		RO	
40873	872	VRMS HARMONIC 6 [%] MSW		Measurement of the Phase - Neutral voltage of the i-th harmonic in comparison with the fundamental [%]	RO	FLOAT32
40874	873	VRMS HARMONIC 6 [%] LSW	L1-N		RO	
40875	874	VRMS HARMONIC 6 [%] MSW		Measurement of the Phase - Neutral voltage of the i-th harmonic in comparison with the fundamental [%]	RO	FLOAT32
40876	875	VRMS HARMONIC 6 [%] LSW	L2-N		RO	
40877	876	VRMS HARMONIC 6 [%] MSW		Measurement of the Phase - Neutral voltage of the i-th harmonic in	RO	FLOAT32
40878	877	VRMS HARMONIC 6 [%] LSW	L3-N		RO	

ADDRESS (4x)	ADDRESS OFFSET	REGISTER	PHASE	DESCRIPTION	W/R	TYPE
				comparison with the fundamental [%]		
<b>40879</b>	878	VRMS HARMONIC 7 [%] MSW	L1-N	Measurement of the Phase - Neutral voltage of the i-th harmonic in comparison with the fundamental [%]	RO	FLOAT32
<b>40880</b>	879	VRMS HARMONIC 7 [%] LSW			RO	
<b>40881</b>	880	VRMS HARMONIC 7 [%] MSW	L2-N	Measurement of the Phase - Neutral voltage of the i-th harmonic in comparison with the fundamental [%]	RO	FLOAT32
<b>40882</b>	881	VRMS HARMONIC 7 [%] LSW			RO	
<b>40883</b>	882	VRMS HARMONIC 7 [%] MSW	L3-N	Measurement of the Phase - Neutral voltage of the i-th harmonic in comparison with the fundamental [%]	RO	FLOAT32
<b>40884</b>	883	VRMS HARMONIC 7 [%] LSW			RO	
<b>40885</b>	884	VRMS HARMONIC 8 [%] MSW	L1-N	Measurement of the Phase - Neutral voltage of the i-th harmonic in comparison with the fundamental [%]	RO	FLOAT32
<b>40886</b>	885	VRMS HARMONIC 8 [%] LSW			RO	
<b>40887</b>	886	VRMS HARMONIC 8 [%] MSW	L2-N	Measurement of the Phase - Neutral voltage of the i-th harmonic in comparison with the fundamental [%]	RO	FLOAT32
<b>40888</b>	887	VRMS HARMONIC 8 [%] LSW			RO	
<b>40889</b>	888	VRMS HARMONIC 8 [%] MSW	L3-N	Measurement of the Phase - Neutral voltage of the i-th harmonic in comparison with the fundamental [%]	RO	FLOAT32
<b>40890</b>	889	VRMS HARMONIC 8 [%] LSW			RO	
<b>40891</b>	890	VRMS HARMONIC 9 [%] MSW	L1-N	Measurement of the Phase - Neutral voltage of the i-th harmonic in comparison with the fundamental [%]	RO	FLOAT32
<b>40892</b>	891	VRMS HARMONIC 9 [%] LSW			RO	
<b>40893</b>	892	VRMS HARMONIC 9 [%] MSW	L2-N	Measurement of the Phase - Neutral voltage of the i-th harmonic in comparison with the fundamental [%]	RO	FLOAT32
<b>40894</b>	893	VRMS HARMONIC 9 [%] LSW			RO	
<b>40895</b>	894	VRMS HARMONIC 9 [%] MSW	L3-N	Measurement of the Phase - Neutral voltage	RO	FLOAT32
<b>40896</b>	895	VRMS HARMONIC 9 [%] LSW			RO	

ADDRESS (4x)	ADDRESS OFFSET	REGISTER	PHASE	DESCRIPTION	W/R	TYPE
				of the i-th harmonic in comparison with the fundamental [%]		
40897	896	VRMS HARMONIC 10 [%] MSW	L1-N	Measurement of the Phase - Neutral voltage of the i-th harmonic in comparison with the fundamental [%]	RO	FLOAT32
40898	897	VRMS HARMONIC 10 [%] LSW			RO	
40899	898	VRMS HARMONIC 10 [%] MSW	L2-N	Measurement of the Phase - Neutral voltage of the i-th harmonic in comparison with the fundamental [%]	RO	FLOAT32
40900	899	VRMS HARMONIC 10 [%] LSW			RO	
40901	900	VRMS HARMONIC 10 [%] MSW	L3-N	Measurement of the Phase - Neutral voltage of the i-th harmonic in comparison with the fundamental [%]	RO	FLOAT32
40902	901	VRMS HARMONIC 10 [%] LSW			RO	
40903	902	VRMS HARMONIC 11 [%] MSW	L1-N	Measurement of the Phase - Neutral voltage of the i-th harmonic in comparison with the fundamental [%]	RO	FLOAT32
40904	903	VRMS HARMONIC 11 [%] LSW			RO	
40905	904	VRMS HARMONIC 11 [%] MSW	L2-N	Measurement of the Phase - Neutral voltage of the i-th harmonic in comparison with the fundamental [%]	RO	FLOAT32
40906	905	VRMS HARMONIC 11 [%] LSW			RO	
40907	906	VRMS HARMONIC 11 [%] MSW	L3-N	Measurement of the Phase - Neutral voltage of the i-th harmonic in comparison with the fundamental [%]	RO	FLOAT32
40908	907	VRMS HARMONIC 11 [%] LSW			RO	
40909	908	VRMS HARMONIC 12 [%] MSW	L1-N	Measurement of the Phase - Neutral voltage of the i-th harmonic in comparison with the fundamental [%]	RO	FLOAT32
40910	909	VRMS HARMONIC 12 [%] LSW			RO	
40911	910	VRMS HARMONIC 12 [%] MSW	L2-N	Measurement of the Phase - Neutral voltage of the i-th harmonic in comparison with the fundamental [%]	RO	FLOAT32
40912	911	VRMS HARMONIC 12 [%] LSW			RO	
40913	912	VRMS HARMONIC 12 [%] MSW	L3-N		RO	FLOAT32

ADDRESS (4x)	ADDRESS OFFSET	REGISTER	PHASE	DESCRIPTION	W/R	TYPE
40914	913	VRMS HARMONIC 12 [%] LSW		Measurement of the Phase - Neutral voltage of the i-th harmonic in comparison with the fundamental [%]	RO	
40915	914	VRMS HARMONIC 13 [%] MSW	L1-N	Measurement of the Phase - Neutral voltage of the i-th harmonic in comparison with the fundamental [%]	RO	FLOAT32
40916	915	VRMS HARMONIC 13 [%] LSW			RO	
40917	916	VRMS HARMONIC 13 [%] MSW	L2-N	Measurement of the Phase - Neutral voltage of the i-th harmonic in comparison with the fundamental [%]	RO	FLOAT32
40918	917	VRMS HARMONIC 13 [%] LSW			RO	
40919	918	VRMS HARMONIC 13 [%] MSW	L3-N	Measurement of the Phase - Neutral voltage of the i-th harmonic in comparison with the fundamental [%]	RO	FLOAT32
40920	919	VRMS HARMONIC 13 [%] LSW			RO	
40921	920	VRMS HARMONIC 14 [%] MSW	L1-N	Measurement of the Phase - Neutral voltage of the i-th harmonic in comparison with the fundamental [%]	RO	FLOAT32
40922	921	VRMS HARMONIC 14 [%] LSW			RO	
40923	922	VRMS HARMONIC 14 [%] MSW	L2-N	Measurement of the Phase - Neutral voltage of the i-th harmonic in comparison with the fundamental [%]	RO	FLOAT32
40924	923	VRMS HARMONIC 14 [%] LSW			RO	
40925	924	VRMS HARMONIC 14 [%] MSW	L3-N	Measurement of the Phase - Neutral voltage of the i-th harmonic in comparison with the fundamental [%]	RO	FLOAT32
40926	925	VRMS HARMONIC 14 [%] LSW			RO	
40927	926	VRMS HARMONIC 15 [%] MSW	L1-N	Measurement of the Phase - Neutral voltage of the i-th harmonic in comparison with the fundamental [%]	RO	FLOAT32
40928	927	VRMS HARMONIC 15 [%] LSW			RO	
40929	928	VRMS HARMONIC 15 [%] MSW	L2-N	Measurement of the Phase - Neutral voltage of the i-th harmonic in	RO	FLOAT32
40930	929	VRMS HARMONIC 15 [%] LSW			RO	

ADDRESS (4x)	ADDRESS OFFSET	REGISTER	PHASE	DESCRIPTION	W/R	TYPE
				comparison with the fundamental [%]		
<b>40931</b>	930	VRMS HARMONIC 15 [%] MSW	L3-N	Measurement of the Phase - Neutral voltage of the i-th harmonic in comparison with the fundamental [%]	RO	FLOAT32
<b>40932</b>	931	VRMS HARMONIC 15 [%] LSW			RO	
<b>40933</b>	932	VRMS HARMONIC 16 [%] MSW	L1-N	Measurement of the Phase - Neutral voltage of the i-th harmonic in comparison with the fundamental [%]	RO	FLOAT32
<b>40934</b>	933	VRMS HARMONIC 16 [%] LSW			RO	
<b>40935</b>	934	VRMS HARMONIC 16 [%] MSW	L2-N	Measurement of the Phase - Neutral voltage of the i-th harmonic in comparison with the fundamental [%]	RO	FLOAT32
<b>40936</b>	935	VRMS HARMONIC 16 [%] LSW			RO	
<b>40937</b>	936	VRMS HARMONIC 16 [%] MSW	L3-N	Measurement of the Phase - Neutral voltage of the i-th harmonic in comparison with the fundamental [%]	RO	FLOAT32
<b>40938</b>	937	VRMS HARMONIC 16 [%] LSW			RO	
<b>40939</b>	938	VRMS HARMONIC 17 [%] MSW	L1-N	Measurement of the Phase - Neutral voltage of the i-th harmonic in comparison with the fundamental [%]	RO	FLOAT32
<b>40940</b>	939	VRMS HARMONIC 17 [%] LSW			RO	
<b>40941</b>	940	VRMS HARMONIC 17 [%] MSW	L2-N	Measurement of the Phase - Neutral voltage of the i-th harmonic in comparison with the fundamental [%]	RO	FLOAT32
<b>40942</b>	941	VRMS HARMONIC 17 [%] LSW			RO	
<b>40943</b>	942	VRMS HARMONIC 17 [%] MSW	L3-N	Measurement of the Phase - Neutral voltage of the i-th harmonic in comparison with the fundamental [%]	RO	FLOAT32
<b>40944</b>	943	VRMS HARMONIC 17 [%] LSW			RO	
<b>40945</b>	944	VRMS HARMONIC 18 [%] MSW	L1-N	Measurement of the Phase - Neutral voltage of the i-th harmonic in comparison with the fundamental [%]	RO	FLOAT32
<b>40946</b>	945	VRMS HARMONIC 18 [%] LSW			RO	
<b>40947</b>	946	VRMS HARMONIC 18 [%] MSW	L2-N	Measurement of the Phase - Neutral voltage	RO	FLOAT32
<b>40948</b>	947	VRMS HARMONIC 18 [%] LSW			RO	



ADDRESS (4x)	ADDRESS OFFSET	REGISTER	PHASE	DESCRIPTION	W/R	TYPE
				of the i-th harmonic in comparison with the fundamental [%]		
<b>40949</b>	948	VRMS HARMONIC 18 [%] MSW	L3-N	Measurement of the Phase - Neutral voltage of the i-th harmonic in comparison with the fundamental [%]	RO	FLOAT32
<b>40950</b>	949	VRMS HARMONIC 18 [%] LSW			RO	
<b>40951</b>	950	VRMS HARMONIC 19 [%] MSW	L1-N	Measurement of the Phase - Neutral voltage of the i-th harmonic in comparison with the fundamental [%]	RO	FLOAT32
<b>40952</b>	951	VRMS HARMONIC 19 [%] LSW			RO	
<b>40953</b>	952	VRMS HARMONIC 19 [%] MSW	L2-N	Measurement of the Phase - Neutral voltage of the i-th harmonic in comparison with the fundamental [%]	RO	FLOAT32
<b>40954</b>	953	VRMS HARMONIC 19 [%] LSW			RO	
<b>40955</b>	954	VRMS HARMONIC 19 [%] MSW	L3-N	Measurement of the Phase - Neutral voltage of the i-th harmonic in comparison with the fundamental [%]	RO	FLOAT32
<b>40956</b>	955	VRMS HARMONIC 19 [%] LSW			RO	
<b>40957</b>	956	VRMS HARMONIC 20 [%] MSW	L1-N	Measurement of the Phase - Neutral voltage of the i-th harmonic in comparison with the fundamental [%]	RO	FLOAT32
<b>40958</b>	957	VRMS HARMONIC 20 [%] LSW			RO	
<b>40959</b>	958	VRMS HARMONIC 20 [%] MSW	L2-N	Measurement of the Phase - Neutral voltage of the i-th harmonic in comparison with the fundamental [%]	RO	FLOAT32
<b>40960</b>	959	VRMS HARMONIC 20 [%] LSW			RO	
<b>40961</b>	960	VRMS HARMONIC 20 [%] MSW	L3-N	Measurement of the Phase - Neutral voltage of the i-th harmonic in comparison with the fundamental [%]	RO	FLOAT32
<b>40962</b>	961	VRMS HARMONIC 20 [%] LSW			RO	
<b>40963</b>	962	VRMS HARMONIC 21 [%] MSW	L1-N	Measurement of the Phase - Neutral voltage of the i-th harmonic in comparison with the fundamental [%]	RO	FLOAT32
<b>40964</b>	963	VRMS HARMONIC 21 [%] LSW			RO	
<b>40965</b>	964	VRMS HARMONIC 21 [%] MSW	L2-N		RO	FLOAT32

ADDRESS (4x)	ADDRESS OFFSET	REGISTER	PHASE	DESCRIPTION	W/R	TYPE
40966	965	VRMS HARMONIC 21 [%] LSW		Measurement of the Phase - Neutral voltage of the i-th harmonic in comparison with the fundamental [%]	RO	
40967	966	VRMS HARMONIC 21 [%] MSW	L3-N	Measurement of the Phase - Neutral voltage of the i-th harmonic in comparison with the fundamental [%]	RO	FLOAT32
40968	967	VRMS HARMONIC 21 [%] LSW			RO	
40969	968	VRMS HARMONIC 22 [%] MSW	L1-N	Measurement of the Phase - Neutral voltage of the i-th harmonic in comparison with the fundamental [%]	RO	FLOAT32
40970	969	VRMS HARMONIC 22 [%] LSW			RO	
40971	970	VRMS HARMONIC 22 [%] MSW	L2-N	Measurement of the Phase - Neutral voltage of the i-th harmonic in comparison with the fundamental [%]	RO	FLOAT32
40972	971	VRMS HARMONIC 22 [%] LSW			RO	
40973	972	VRMS HARMONIC 22 [%] MSW	L3-N	Measurement of the Phase - Neutral voltage of the i-th harmonic in comparison with the fundamental [%]	RO	FLOAT32
40974	973	VRMS HARMONIC 22 [%] LSW			RO	
40975	974	VRMS HARMONIC 23 [%] MSW	L1-N	Measurement of the Phase - Neutral voltage of the i-th harmonic in comparison with the fundamental [%]	RO	FLOAT32
40976	975	VRMS HARMONIC 23 [%] LSW			RO	
40977	976	VRMS HARMONIC 23 [%] MSW	L2-N	Measurement of the Phase - Neutral voltage of the i-th harmonic in comparison with the fundamental [%]	RO	FLOAT32
40978	977	VRMS HARMONIC 23 [%] LSW			RO	
40979	978	VRMS HARMONIC 23 [%] MSW	L3-N	Measurement of the Phase - Neutral voltage of the i-th harmonic in comparison with the fundamental [%]	RO	FLOAT32
40980	979	VRMS HARMONIC 23 [%] LSW			RO	
40981	980	VRMS HARMONIC 24 [%] MSW	L1-N	Measurement of the Phase - Neutral voltage of the i-th harmonic in	RO	FLOAT32
40982	981	VRMS HARMONIC 24 [%] LSW			RO	

ADDRESS (4x)	ADDRESS OFFSET	REGISTER	PHASE	DESCRIPTION	W/R	TYPE
				comparison with the fundamental [%]		
<b>40983</b>	982	VRMS HARMONIC 24 [%] MSW	L2-N	Measurement of the Phase - Neutral voltage of the i-th harmonic in comparison with the fundamental [%]	RO	FLOAT32
<b>40984</b>	983	VRMS HARMONIC 24 [%] LSW			RO	
<b>40985</b>	984	VRMS HARMONIC 24 [%] MSW	L3-N	Measurement of the Phase - Neutral voltage of the i-th harmonic in comparison with the fundamental [%]	RO	FLOAT32
<b>40986</b>	985	VRMS HARMONIC 24 [%] LSW			RO	
<b>40987</b>	986	VRMS HARMONIC 25 [%] MSW	L1-N	Measurement of the Phase - Neutral voltage of the i-th harmonic in comparison with the fundamental [%]	RO	FLOAT32
<b>40988</b>	987	VRMS HARMONIC 25 [%] LSW			RO	
<b>40989</b>	988	VRMS HARMONIC 25 [%] MSW	L2-N	Measurement of the Phase - Neutral voltage of the i-th harmonic in comparison with the fundamental [%]	RO	FLOAT32
<b>40990</b>	989	VRMS HARMONIC 25 [%] LSW			RO	
<b>40991</b>	990	VRMS HARMONIC 25 [%] MSW	L3-N	Measurement of the Phase - Neutral voltage of the i-th harmonic in comparison with the fundamental [%]	RO	FLOAT32
<b>40992</b>	991	VRMS HARMONIC 25 [%] LSW			RO	
<b>40993</b>	992	VRMS HARMONIC 26 [%] MSW	L1-N	Measurement of the Phase - Neutral voltage of the i-th harmonic in comparison with the fundamental [%]	RO	FLOAT32
<b>40994</b>	993	VRMS HARMONIC 26 [%] LSW			RO	
<b>40995</b>	994	VRMS HARMONIC 26 [%] MSW	L2-N	Measurement of the Phase - Neutral voltage of the i-th harmonic in comparison with the fundamental [%]	RO	FLOAT32
<b>40996</b>	995	VRMS HARMONIC 26 [%] LSW			RO	
<b>40997</b>	996	VRMS HARMONIC 26 [%] MSW	L3-N	Measurement of the Phase - Neutral voltage of the i-th harmonic in comparison with the fundamental [%]	RO	FLOAT32
<b>40998</b>	997	VRMS HARMONIC 26 [%] LSW			RO	
<b>40999</b>	998	VRMS HARMONIC 27 [%] MSW	L1-N	Measurement of the Phase - Neutral voltage	RO	FLOAT32
<b>41000</b>	999	VRMS HARMONIC 27 [%] LSW			RO	

ADDRESS (4x)	ADDRESS OFFSET	REGISTER	PHASE	DESCRIPTION	W/R	TYPE
				of the i-th harmonic in comparison with the fundamental [%]		
<b>41001</b>	1000	VRMS HARMONIC 27 [%] MSW	L2-N	Measurement of the Phase - Neutral voltage of the i-th harmonic in comparison with the fundamental [%]	RO	FLOAT32
<b>41002</b>	1001	VRMS HARMONIC 27 [%] LSW			RO	
<b>41003</b>	1002	VRMS HARMONIC 27 [%] MSW	L3-N	Measurement of the Phase - Neutral voltage of the i-th harmonic in comparison with the fundamental [%]	RO	FLOAT32
<b>41004</b>	1003	VRMS HARMONIC 27 [%] LSW			RO	
<b>41005</b>	1004	VRMS HARMONIC 28 [%] MSW	L1-N	Measurement of the Phase - Neutral voltage of the i-th harmonic in comparison with the fundamental [%]	RO	FLOAT32
<b>41006</b>	1005	VRMS HARMONIC 28 [%] LSW			RO	
<b>41007</b>	1006	VRMS HARMONIC 28 [%] MSW	L2-N	Measurement of the Phase - Neutral voltage of the i-th harmonic in comparison with the fundamental [%]	RO	FLOAT32
<b>41008</b>	1007	VRMS HARMONIC 28 [%] LSW			RO	
<b>41009</b>	1008	VRMS HARMONIC 28 [%] MSW	L3-N	Measurement of the Phase - Neutral voltage of the i-th harmonic in comparison with the fundamental [%]	RO	FLOAT32
<b>41010</b>	1009	VRMS HARMONIC 28 [%] LSW			RO	
<b>41011</b>	1010	VRMS HARMONIC 29 [%] MSW	L1-N	Measurement of the Phase - Neutral voltage of the i-th harmonic in comparison with the fundamental [%]	RO	FLOAT32
<b>41012</b>	1011	VRMS HARMONIC 29 [%] LSW			RO	
<b>41013</b>	1012	VRMS HARMONIC 29 [%] MSW	L2-N	Measurement of the Phase - Neutral voltage of the i-th harmonic in comparison with the fundamental [%]	RO	FLOAT32
<b>41014</b>	1013	VRMS HARMONIC 29 [%] LSW			RO	
<b>41015</b>	1014	VRMS HARMONIC 29 [%] MSW	L3-N	Measurement of the Phase - Neutral voltage of the i-th harmonic in comparison with the fundamental [%]	RO	FLOAT32
<b>41016</b>	1015	VRMS HARMONIC 29 [%] LSW			RO	
<b>41017</b>	1016	VRMS HARMONIC 30 [%] MSW	L1-N		RO	FLOAT32

ADDRESS (4x)	ADDRESS OFFSET	REGISTER	PHASE	DESCRIPTION	W/R	TYPE
41018	1017	VRMS HARMONIC 30 [%] LSW		Measurement of the Phase - Neutral voltage of the i-th harmonic in comparison with the fundamental [%]	RO	
41019	1018	VRMS HARMONIC 30 [%] MSW	L2-N	Measurement of the Phase - Neutral voltage of the i-th harmonic in comparison with the fundamental [%]	RO	FLOAT32
41020	1019	VRMS HARMONIC 30 [%] LSW			RO	
41021	1020	VRMS HARMONIC 30 [%] MSW	L3-N	Measurement of the Phase - Neutral voltage of the i-th harmonic in comparison with the fundamental [%]	RO	FLOAT32
41022	1021	VRMS HARMONIC 30 [%] LSW			RO	
41023	1022	VRMS HARMONIC 31 [%] MSW	L1-N	Measurement of the Phase - Neutral voltage of the i-th harmonic in comparison with the fundamental [%]	RO	FLOAT32
41024	1023	VRMS HARMONIC 31 [%] LSW			RO	
41025	1024	VRMS HARMONIC 31 [%] MSW	L2-N	Measurement of the Phase - Neutral voltage of the i-th harmonic in comparison with the fundamental [%]	RO	FLOAT32
41026	1025	VRMS HARMONIC 31 [%] LSW			RO	
41027	1026	VRMS HARMONIC 31 [%] MSW	L3-N	Measurement of the Phase - Neutral voltage of the i-th harmonic in comparison with the fundamental [%]	RO	FLOAT32
41028	1027	VRMS HARMONIC 31 [%] LSW			RO	
41029	1028	VRMS HARMONIC 32 [%] MSW	L1-N	Measurement of the Phase - Neutral voltage of the i-th harmonic in comparison with the fundamental [%]	RO	FLOAT32
41030	1029	VRMS HARMONIC 32 [%] LSW			RO	
41031	1030	VRMS HARMONIC 32 [%] MSW	L2-N	Measurement of the Phase - Neutral voltage of the i-th harmonic in comparison with the fundamental [%]	RO	FLOAT32
41032	1031	VRMS HARMONIC 32 [%] LSW			RO	
41033	1032	VRMS HARMONIC 32 [%] MSW	L3-N	Measurement of the Phase - Neutral voltage of the i-th harmonic in	RO	FLOAT32
41034	1033	VRMS HARMONIC 32 [%] LSW			RO	

ADDRESS (4x)	ADDRESS OFFSET	REGISTER	PHASE	DESCRIPTION	W/R	TYPE
				comparison with the fundamental [%]		
<b>41035</b>	1034	VRMS HARMONIC 33 [%] MSW	L1-N	Measurement of the Phase - Neutral voltage of the i-th harmonic in comparison with the fundamental [%]	RO	FLOAT32
<b>41036</b>	1035	VRMS HARMONIC 33 [%] LSW			RO	
<b>41037</b>	1036	VRMS HARMONIC 33 [%] MSW	L2-N	Measurement of the Phase - Neutral voltage of the i-th harmonic in comparison with the fundamental [%]	RO	FLOAT32
<b>41038</b>	1037	VRMS HARMONIC 33 [%] LSW			RO	
<b>41039</b>	1038	VRMS HARMONIC 33 [%] MSW	L3-N	Measurement of the Phase - Neutral voltage of the i-th harmonic in comparison with the fundamental [%]	RO	FLOAT32
<b>41040</b>	1039	VRMS HARMONIC 33 [%] LSW			RO	
<b>41041</b>	1040	VRMS HARMONIC 34 [%] MSW	L1-N	Measurement of the Phase - Neutral voltage of the i-th harmonic in comparison with the fundamental [%]	RO	FLOAT32
<b>41042</b>	1041	VRMS HARMONIC 34 [%] LSW			RO	
<b>41043</b>	1042	VRMS HARMONIC 34 [%] MSW	L2-N	Measurement of the Phase - Neutral voltage of the i-th harmonic in comparison with the fundamental [%]	RO	FLOAT32
<b>41044</b>	1043	VRMS HARMONIC 34 [%] LSW			RO	
<b>41045</b>	1044	VRMS HARMONIC 34 [%] MSW	L3-N	Measurement of the Phase - Neutral voltage of the i-th harmonic in comparison with the fundamental [%]	RO	FLOAT32
<b>41046</b>	1045	VRMS HARMONIC 34 [%] LSW			RO	
<b>41047</b>	1046	VRMS HARMONIC 35 [%] MSW	L1-N	Measurement of the Phase - Neutral voltage of the i-th harmonic in comparison with the fundamental [%]	RO	FLOAT32
<b>41048</b>	1047	VRMS HARMONIC 35 [%] LSW			RO	
<b>41049</b>	1048	VRMS HARMONIC 35 [%] MSW	L2-N	Measurement of the Phase - Neutral voltage of the i-th harmonic in comparison with the fundamental [%]	RO	FLOAT32
<b>41050</b>	1049	VRMS HARMONIC 35 [%] LSW			RO	
<b>41051</b>	1050	VRMS HARMONIC 35 [%] MSW	L3-N	Measurement of the Phase - Neutral voltage	RO	FLOAT32
<b>41052</b>	1051	VRMS HARMONIC 35 [%] LSW			RO	

ADDRESS (4x)	ADDRESS OFFSET	REGISTER	PHASE	DESCRIPTION	W/R	TYPE
				of the i-th harmonic in comparison with the fundamental [%]		
<b>41053</b>	1052	VRMS HARMONIC 36 [%] MSW	L1-N	Measurement of the Phase - Neutral voltage of the i-th harmonic in comparison with the fundamental [%]	RO	FLOAT32
<b>41054</b>	1053	VRMS HARMONIC 36 [%] LSW			RO	
<b>41055</b>	1054	VRMS HARMONIC 36 [%] MSW	L2-N	Measurement of the Phase - Neutral voltage of the i-th harmonic in comparison with the fundamental [%]	RO	FLOAT32
<b>41056</b>	1055	VRMS HARMONIC 36 [%] LSW			RO	
<b>41057</b>	1056	VRMS HARMONIC 36 [%] MSW	L3-N	Measurement of the Phase - Neutral voltage of the i-th harmonic in comparison with the fundamental [%]	RO	FLOAT32
<b>41058</b>	1057	VRMS HARMONIC 36 [%] LSW			RO	
<b>41059</b>	1058	VRMS HARMONIC 37 [%] MSW	L1-N	Measurement of the Phase - Neutral voltage of the i-th harmonic in comparison with the fundamental [%]	RO	FLOAT32
<b>41060</b>	1059	VRMS HARMONIC 37 [%] LSW			RO	
<b>41061</b>	1060	VRMS HARMONIC 37 [%] MSW	L2-N	Measurement of the Phase - Neutral voltage of the i-th harmonic in comparison with the fundamental [%]	RO	FLOAT32
<b>41062</b>	1061	VRMS HARMONIC 37 [%] LSW			RO	
<b>41063</b>	1062	VRMS HARMONIC 37 [%] MSW	L3-N	Measurement of the Phase - Neutral voltage of the i-th harmonic in comparison with the fundamental [%]	RO	FLOAT32
<b>41064</b>	1063	VRMS HARMONIC 37 [%] LSW			RO	
<b>41065</b>	1064	VRMS HARMONIC 38 [%] MSW	L1-N	Measurement of the Phase - Neutral voltage of the i-th harmonic in comparison with the fundamental [%]	RO	FLOAT32
<b>41066</b>	1065	VRMS HARMONIC 38 [%] LSW			RO	
<b>41067</b>	1066	VRMS HARMONIC 38 [%] MSW	L2-N	Measurement of the Phase - Neutral voltage of the i-th harmonic in comparison with the fundamental [%]	RO	FLOAT32
<b>41068</b>	1067	VRMS HARMONIC 38 [%] LSW			RO	
<b>41069</b>	1068	VRMS HARMONIC 38 [%] MSW	L3-N		RO	FLOAT32

ADDRESS (4x)	ADDRESS OFFSET	REGISTER	PHASE	DESCRIPTION	W/R	TYPE
41070	1069	VRMS HARMONIC 38 [%] LSW		Measurement of the Phase - Neutral voltage of the i-th harmonic in comparison with the fundamental [%]	RO	
41071	1070	VRMS HARMONIC 39 [%] MSW	L1-N	Measurement of the Phase - Neutral voltage of the i-th harmonic in comparison with the fundamental [%]	RO	FLOAT32
41072	1071	VRMS HARMONIC 39 [%] LSW			RO	
41073	1072	VRMS HARMONIC 39 [%] MSW	L2-N	Measurement of the Phase - Neutral voltage of the i-th harmonic in comparison with the fundamental [%]	RO	FLOAT32
41074	1073	VRMS HARMONIC 39 [%] LSW			RO	
41075	1074	VRMS HARMONIC 39 [%] MSW	L3-N	Measurement of the Phase - Neutral voltage of the i-th harmonic in comparison with the fundamental [%]	RO	FLOAT32
41076	1075	VRMS HARMONIC 39 [%] LSW			RO	
41077	1076	VRMS HARMONIC 40 [%] MSW	L1-N	Measurement of the Phase - Neutral voltage of the i-th harmonic in comparison with the fundamental [%]	RO	FLOAT32
41078	1077	VRMS HARMONIC 40 [%] LSW			RO	
41079	1078	VRMS HARMONIC 40 [%] MSW	L2-N	Measurement of the Phase - Neutral voltage of the i-th harmonic in comparison with the fundamental [%]	RO	FLOAT32
41080	1079	VRMS HARMONIC 40 [%] LSW			RO	
41081	1080	VRMS HARMONIC 40 [%] MSW	L3-N	Measurement of the Phase - Neutral voltage of the i-th harmonic in comparison with the fundamental [%]	RO	FLOAT32
41082	1081	VRMS HARMONIC 40 [%] LSW			RO	
41083	1082	VRMS HARMONIC 41 [%] MSW	L1-N	Measurement of the Phase - Neutral voltage of the i-th harmonic in comparison with the fundamental [%]	RO	FLOAT32
41084	1083	VRMS HARMONIC 41 [%] LSW			RO	
41085	1084	VRMS HARMONIC 41 [%] MSW	L2-N	Measurement of the Phase - Neutral voltage of the i-th harmonic in	RO	FLOAT32
41086	1085	VRMS HARMONIC 41 [%] LSW			RO	



ADDRESS (4x)	ADDRESS OFFSET	REGISTER	PHASE	DESCRIPTION	W/R	TYPE
				comparison with the fundamental [%]		
<b>41087</b>	1086	VRMS HARMONIC 41 [%] MSW	L3-N	Measurement of the Phase - Neutral voltage of the i-th harmonic in comparison with the fundamental [%]	RO	FLOAT32
<b>41088</b>	1087	VRMS HARMONIC 41 [%] LSW			RO	
<b>41089</b>	1088	VRMS HARMONIC 42 [%] MSW	L1-N	Measurement of the Phase - Neutral voltage of the i-th harmonic in comparison with the fundamental [%]	RO	FLOAT32
<b>41090</b>	1089	VRMS HARMONIC 42 [%] LSW			RO	
<b>41091</b>	1090	VRMS HARMONIC 42 [%] MSW	L2-N	Measurement of the Phase - Neutral voltage of the i-th harmonic in comparison with the fundamental [%]	RO	FLOAT32
<b>41092</b>	1091	VRMS HARMONIC 42 [%] LSW			RO	
<b>41093</b>	1092	VRMS HARMONIC 42 [%] MSW	L3-N	Measurement of the Phase - Neutral voltage of the i-th harmonic in comparison with the fundamental [%]	RO	FLOAT32
<b>41094</b>	1093	VRMS HARMONIC 42 [%] LSW			RO	
<b>41095</b>	1094	VRMS HARMONIC 43 [%] MSW	L1-N	Measurement of the Phase - Neutral voltage of the i-th harmonic in comparison with the fundamental [%]	RO	FLOAT32
<b>41096</b>	1095	VRMS HARMONIC 43 [%] LSW			RO	
<b>41097</b>	1096	VRMS HARMONIC 43 [%] MSW	L2-N	Measurement of the Phase - Neutral voltage of the i-th harmonic in comparison with the fundamental [%]	RO	FLOAT32
<b>41098</b>	1097	VRMS HARMONIC 43 [%] LSW			RO	
<b>41099</b>	1098	VRMS HARMONIC 43 [%] MSW	L3-N	Measurement of the Phase - Neutral voltage of the i-th harmonic in comparison with the fundamental [%]	RO	FLOAT32
<b>41100</b>	1099	VRMS HARMONIC 43 [%] LSW			RO	
<b>41101</b>	1100	VRMS HARMONIC 44 [%] MSW	L1-N	Measurement of the Phase - Neutral voltage of the i-th harmonic in comparison with the fundamental [%]	RO	FLOAT32
<b>41102</b>	1101	VRMS HARMONIC 44 [%] LSW			RO	
<b>41103</b>	1102	VRMS HARMONIC 44 [%] MSW	L2-N	Measurement of the Phase - Neutral voltage	RO	FLOAT32
<b>41104</b>	1103	VRMS HARMONIC 44 [%] LSW			RO	

ADDRESS (4x)	ADDRESS OFFSET	REGISTER	PHASE	DESCRIPTION	W/R	TYPE
				of the i-th harmonic in comparison with the fundamental [%]		
<b>41105</b>	1104	VRMS HARMONIC 44 [%] MSW	L3-N	Measurement of the Phase - Neutral voltage of the i-th harmonic in comparison with the fundamental [%]	RO	FLOAT32
<b>41106</b>	1105	VRMS HARMONIC 44 [%] LSW			RO	
<b>41107</b>	1106	VRMS HARMONIC 45 [%] MSW	L1-N	Measurement of the Phase - Neutral voltage of the i-th harmonic in comparison with the fundamental [%]	RO	FLOAT32
<b>41108</b>	1107	VRMS HARMONIC 45 [%] LSW			RO	
<b>41109</b>	1108	VRMS HARMONIC 45 [%] MSW	L2-N	Measurement of the Phase - Neutral voltage of the i-th harmonic in comparison with the fundamental [%]	RO	FLOAT32
<b>41110</b>	1109	VRMS HARMONIC 45 [%] LSW			RO	
<b>41111</b>	1110	VRMS HARMONIC 45 [%] MSW	L3-N	Measurement of the Phase - Neutral voltage of the i-th harmonic in comparison with the fundamental [%]	RO	FLOAT32
<b>41112</b>	1111	VRMS HARMONIC 45 [%] LSW			RO	
<b>41113</b>	1112	VRMS HARMONIC 46 [%] MSW	L1-N	Measurement of the Phase - Neutral voltage of the i-th harmonic in comparison with the fundamental [%]	RO	FLOAT32
<b>41114</b>	1113	VRMS HARMONIC 46 [%] LSW			RO	
<b>41115</b>	1114	VRMS HARMONIC 46 [%] MSW	L2-N	Measurement of the Phase - Neutral voltage of the i-th harmonic in comparison with the fundamental [%]	RO	FLOAT32
<b>41116</b>	1115	VRMS HARMONIC 46 [%] LSW			RO	
<b>41117</b>	1116	VRMS HARMONIC 46 [%] MSW	L3-N	Measurement of the Phase - Neutral voltage of the i-th harmonic in comparison with the fundamental [%]	RO	FLOAT32
<b>41118</b>	1117	VRMS HARMONIC 46 [%] LSW			RO	
<b>41119</b>	1118	VRMS HARMONIC 47 [%] MSW	L1-N	Measurement of the Phase - Neutral voltage of the i-th harmonic in comparison with the fundamental [%]	RO	FLOAT32
<b>41120</b>	1119	VRMS HARMONIC 47 [%] LSW			RO	
<b>41121</b>	1120	VRMS HARMONIC 47 [%] MSW	L2-N		RO	FLOAT32

ADDRESS (4x)	ADDRESS OFFSET	REGISTER	PHASE	DESCRIPTION	W/R	TYPE
41122	1121	VRMS HARMONIC 47 [%] LSW		Measurement of the Phase - Neutral voltage of the i-th harmonic in comparison with the fundamental [%]	RO	
41123	1122	VRMS HARMONIC 47 [%] MSW	L3-N	Measurement of the Phase - Neutral voltage of the i-th harmonic in comparison with the fundamental [%]	RO	FLOAT32
41124	1123	VRMS HARMONIC 47 [%] LSW			RO	
41125	1124	VRMS HARMONIC 48 [%] MSW	L1-N	Measurement of the Phase - Neutral voltage of the i-th harmonic in comparison with the fundamental [%]	RO	FLOAT32
41126	1125	VRMS HARMONIC 48 [%] LSW			RO	
41127	1126	VRMS HARMONIC 48 [%] MSW	L2-N	Measurement of the Phase - Neutral voltage of the i-th harmonic in comparison with the fundamental [%]	RO	FLOAT32
41128	1127	VRMS HARMONIC 48 [%] LSW			RO	
41129	1128	VRMS HARMONIC 48 [%] MSW	L3-N	Measurement of the Phase - Neutral voltage of the i-th harmonic in comparison with the fundamental [%]	RO	FLOAT32
41130	1129	VRMS HARMONIC 48 [%] LSW			RO	
41131	1130	VRMS HARMONIC 49 [%] MSW	L1-N	Measurement of the Phase - Neutral voltage of the i-th harmonic in comparison with the fundamental [%]	RO	FLOAT32
41132	1131	VRMS HARMONIC 49 [%] LSW			RO	
41133	1132	VRMS HARMONIC 49 [%] MSW	L2-N	Measurement of the Phase - Neutral voltage of the i-th harmonic in comparison with the fundamental [%]	RO	FLOAT32
41134	1133	VRMS HARMONIC 49 [%] LSW			RO	
41135	1134	VRMS HARMONIC 49 [%] MSW	L3-N	Measurement of the Phase - Neutral voltage of the i-th harmonic in comparison with the fundamental [%]	RO	FLOAT32
41136	1135	VRMS HARMONIC 49 [%] LSW			RO	
41137	1136	VRMS HARMONIC 50 [%] MSW	L1-N	Measurement of the Phase - Neutral voltage of the i-th harmonic in	RO	FLOAT32
41138	1137	VRMS HARMONIC 50 [%] LSW			RO	

ADDRESS (4x)	ADDRESS OFFSET	REGISTER	PHASE	DESCRIPTION	W/R	TYPE
				comparison with the fundamental [%]		
<b>41139</b>	1138	VRMS HARMONIC 50 [%] MSW	L2-N	Measurement of the Phase - Neutral voltage of the i-th harmonic in comparison with the fundamental [%]	RO	FLOAT32
<b>41140</b>	1139	VRMS HARMONIC 50 [%] LSW			RO	
<b>41141</b>	1140	VRMS HARMONIC 50 [%] MSW	L3-N	Measurement of the Phase - Neutral voltage of the i-th harmonic in comparison with the fundamental [%]	RO	FLOAT32
<b>41142</b>	1141	VRMS HARMONIC 50 [%] LSW			RO	
<b>41143</b>	1142	VRMS HARMONIC 51 [%] MSW	L1-N	Measurement of the Phase - Neutral voltage of the i-th harmonic in comparison with the fundamental [%]	RO	FLOAT32
<b>41144</b>	1143	VRMS HARMONIC 51 [%] LSW			RO	
<b>41145</b>	1144	VRMS HARMONIC 51 [%] MSW	L2-N	Measurement of the Phase - Neutral voltage of the i-th harmonic in comparison with the fundamental [%]	RO	FLOAT32
<b>41146</b>	1145	VRMS HARMONIC 51 [%] LSW			RO	
<b>41147</b>	1146	VRMS HARMONIC 51 [%] MSW	L3-N	Measurement of the Phase - Neutral voltage of the i-th harmonic in comparison with the fundamental [%]	RO	FLOAT32
<b>41148</b>	1147	VRMS HARMONIC 51 [%] LSW			RO	
<b>41149</b>	1148	VRMS HARMONIC 52 [%] MSW	L1-N	Measurement of the Phase - Neutral voltage of the i-th harmonic in comparison with the fundamental [%]	RO	FLOAT32
<b>41150</b>	1149	VRMS HARMONIC 52 [%] LSW			RO	
<b>41151</b>	1150	VRMS HARMONIC 52 [%] MSW	L2-N	Measurement of the Phase - Neutral voltage of the i-th harmonic in comparison with the fundamental [%]	RO	FLOAT32
<b>41152</b>	1151	VRMS HARMONIC 52 [%] LSW			RO	
<b>41153</b>	1152	VRMS HARMONIC 52 [%] MSW	L3-N	Measurement of the Phase - Neutral voltage of the i-th harmonic in comparison with the fundamental [%]	RO	FLOAT32
<b>41154</b>	1153	VRMS HARMONIC 52 [%] LSW			RO	
<b>41155</b>	1154	VRMS HARMONIC 53 [%] MSW	L1-N	Measurement of the Phase - Neutral voltage	RO	FLOAT32
<b>41156</b>	1155	VRMS HARMONIC 53 [%] LSW			RO	

ADDRESS (4x)	ADDRESS OFFSET	REGISTER	PHASE	DESCRIPTION	W/R	TYPE
				of the i-th harmonic in comparison with the fundamental [%]		
<b>41157</b>	1156	VRMS HARMONIC 53 [%] MSW	L2-N	Measurement of the Phase - Neutral voltage of the i-th harmonic in comparison with the fundamental [%]	RO	FLOAT32
<b>41158</b>	1157	VRMS HARMONIC 53 [%] LSW			RO	
<b>41159</b>	1158	VRMS HARMONIC 53 [%] MSW	L3-N	Measurement of the Phase - Neutral voltage of the i-th harmonic in comparison with the fundamental [%]	RO	FLOAT32
<b>41160</b>	1159	VRMS HARMONIC 53 [%] LSW			RO	
<b>41161</b>	1160	VRMS HARMONIC 54 [%] MSW	L1-N	Measurement of the Phase - Neutral voltage of the i-th harmonic in comparison with the fundamental [%]	RO	FLOAT32
<b>41162</b>	1161	VRMS HARMONIC 54 [%] LSW			RO	
<b>41163</b>	1162	VRMS HARMONIC 54 [%] MSW	L2-N	Measurement of the Phase - Neutral voltage of the i-th harmonic in comparison with the fundamental [%]	RO	FLOAT32
<b>41164</b>	1163	VRMS HARMONIC 54 [%] LSW			RO	
<b>41165</b>	1164	VRMS HARMONIC 54 [%] MSW	L3-N	Measurement of the Phase - Neutral voltage of the i-th harmonic in comparison with the fundamental [%]	RO	FLOAT32
<b>41166</b>	1165	VRMS HARMONIC 54 [%] LSW			RO	
<b>41167</b>	1166	VRMS HARMONIC 55 [%] MSW	L1-N	Measurement of the Phase - Neutral voltage of the i-th harmonic in comparison with the fundamental [%]	RO	FLOAT32
<b>41168</b>	1167	VRMS HARMONIC 55 [%] LSW			RO	
<b>41169</b>	1168	VRMS HARMONIC 55 [%] MSW	L2-N	Measurement of the Phase - Neutral voltage of the i-th harmonic in comparison with the fundamental [%]	RO	FLOAT32
<b>41170</b>	1169	VRMS HARMONIC 55 [%] LSW			RO	
<b>41171</b>	1170	VRMS HARMONIC 55 [%] MSW	L3-N	Measurement of the Phase - Neutral voltage of the i-th harmonic in comparison with the fundamental [%]	RO	FLOAT32
<b>41172</b>	1171	VRMS HARMONIC 55 [%] LSW			RO	
<b>41173</b>	1172	IRMS HARMONIC 2 [%] MSW	L1		RO	FLOAT32

ADDRESS (4x)	ADDRESS OFFSET	REGISTER	PHASE	DESCRIPTION	W/R	TYPE
41174	1173	IRMS HARMONIC 2 [%] LSW		Measurement of the Phase - Neutral current of the i-th harmonic in comparison with the fundamental [%]	RO	
41175	1174	IRMS HARMONIC 2 [%] MSW	L2	Measurement of the Phase - Neutral current of the i-th harmonic in comparison with the fundamental [%]	RO	FLOAT32
41176	1175	IRMS HARMONIC 2 [%] LSW			RO	
41177	1176	IRMS HARMONIC 2 [%] MSW	L3	Measurement of the Phase - Neutral current of the i-th harmonic in comparison with the fundamental [%]	RO	FLOAT32
41178	1177	IRMS HARMONIC 2 [%] LSW			RO	
41179	1178	IRMS HARMONIC 3 [%] MSW	L1	Measurement of the Phase - Neutral current of the i-th harmonic in comparison with the fundamental [%]	RO	FLOAT32
41180	1179	IRMS HARMONIC 3 [%] LSW			RO	
41181	1180	IRMS HARMONIC 3 [%] MSW	L2	Measurement of the Phase - Neutral current of the i-th harmonic in comparison with the fundamental [%]	RO	FLOAT32
41182	1181	IRMS HARMONIC 3 [%] LSW			RO	
41183	1182	IRMS HARMONIC 3 [%] MSW	L3	Measurement of the Phase - Neutral current of the i-th harmonic in comparison with the fundamental [%]	RO	FLOAT32
41184	1183	IRMS HARMONIC 3 [%] LSW			RO	
41185	1184	IRMS HARMONIC 4 [%] MSW	L1	Measurement of the Phase - Neutral current of the i-th harmonic in comparison with the fundamental [%]	RO	FLOAT32
41186	1185	IRMS HARMONIC 4 [%] LSW			RO	
41187	1186	IRMS HARMONIC 4 [%] MSW	L2	Measurement of the Phase - Neutral current of the i-th harmonic in comparison with the fundamental [%]	RO	FLOAT32
41188	1187	IRMS HARMONIC 4 [%] LSW			RO	
41189	1188	IRMS HARMONIC 4 [%] MSW	L3	Measurement of the Phase - Neutral current of the i-th harmonic in	RO	FLOAT32
41190	1189	IRMS HARMONIC 4 [%] LSW			RO	

ADDRESS (4x)	ADDRESS OFFSET	REGISTER	PHASE	DESCRIPTION	W/R	TYPE
				comparison with the fundamental [%]		
<b>41191</b>	1190	IRMS HARMONIC 5 [%] MSW	L1	Measurement of the Phase - Neutral current of the i-th harmonic in comparison with the fundamental [%]	RO	FLOAT32
<b>41192</b>	1191	IRMS HARMONIC 5 [%] LSW			RO	
<b>41193</b>	1192	IRMS HARMONIC 5 [%] MSW	L2	Measurement of the Phase - Neutral current of the i-th harmonic in comparison with the fundamental [%]	RO	FLOAT32
<b>41194</b>	1193	IRMS HARMONIC 5 [%] LSW			RO	
<b>41195</b>	1194	IRMS HARMONIC 5 [%] MSW	L3	Measurement of the Phase - Neutral current of the i-th harmonic in comparison with the fundamental [%]	RO	FLOAT32
<b>41196</b>	1195	IRMS HARMONIC 5 [%] LSW			RO	
<b>41197</b>	1196	IRMS HARMONIC 6 [%] MSW	L1	Measurement of the Phase - Neutral current of the i-th harmonic in comparison with the fundamental [%]	RO	FLOAT32
<b>41198</b>	1197	IRMS HARMONIC 6 [%] LSW			RO	
<b>41199</b>	1198	IRMS HARMONIC 6 [%] MSW	L2	Measurement of the Phase - Neutral current of the i-th harmonic in comparison with the fundamental [%]	RO	FLOAT32
<b>41200</b>	1199	IRMS HARMONIC 6 [%] LSW			RO	
<b>41201</b>	1200	IRMS HARMONIC 6 [%] MSW	L3	Measurement of the Phase - Neutral current of the i-th harmonic in comparison with the fundamental [%]	RO	FLOAT32
<b>41202</b>	1201	IRMS HARMONIC 6 [%] LSW			RO	
<b>41203</b>	1202	IRMS HARMONIC 7 [%] MSW	L1	Measurement of the Phase - Neutral current of the i-th harmonic in comparison with the fundamental [%]	RO	FLOAT32
<b>41204</b>	1203	IRMS HARMONIC 7 [%] LSW			RO	
<b>41205</b>	1204	IRMS HARMONIC 7 [%] MSW	L2	Measurement of the Phase - Neutral current of the i-th harmonic in comparison with the fundamental [%]	RO	FLOAT32
<b>41206</b>	1205	IRMS HARMONIC 7 [%] LSW			RO	
<b>41207</b>	1206	IRMS HARMONIC 7 [%] MSW	L3	Measurement of the Phase - Neutral current	RO	FLOAT32
<b>41208</b>	1207	IRMS HARMONIC 7 [%] LSW			RO	

ADDRESS (4x)	ADDRESS OFFSET	REGISTER	PHASE	DESCRIPTION	W/R	TYPE
				of the i-th harmonic in comparison with the fundamental [%]		
<b>41209</b>	1208	IRMS HARMONIC 8 [%] MSW	L1	Measurement of the Phase - Neutral current of the i-th harmonic in comparison with the fundamental [%]	RO	FLOAT32
<b>41210</b>	1209	IRMS HARMONIC 8 [%] LSW			RO	
<b>41211</b>	1210	IRMS HARMONIC 8 [%] MSW	L2	Measurement of the Phase - Neutral current of the i-th harmonic in comparison with the fundamental [%]	RO	FLOAT32
<b>41212</b>	1211	IRMS HARMONIC 8 [%] LSW			RO	
<b>41213</b>	1212	IRMS HARMONIC 8 [%] MSW	L3	Measurement of the Phase - Neutral current of the i-th harmonic in comparison with the fundamental [%]	RO	FLOAT32
<b>41214</b>	1213	IRMS HARMONIC 8 [%] LSW			RO	
<b>41215</b>	1214	IRMS HARMONIC 9 [%] MSW	L1	Measurement of the Phase - Neutral current of the i-th harmonic in comparison with the fundamental [%]	RO	FLOAT32
<b>41216</b>	1215	IRMS HARMONIC 9 [%] LSW			RO	
<b>41217</b>	1216	IRMS HARMONIC 9 [%] MSW	L2	Measurement of the Phase - Neutral current of the i-th harmonic in comparison with the fundamental [%]	RO	FLOAT32
<b>41218</b>	1217	IRMS HARMONIC 9 [%] LSW			RO	
<b>41219</b>	1218	IRMS HARMONIC 9 [%] MSW	L3	Measurement of the Phase - Neutral current of the i-th harmonic in comparison with the fundamental [%]	RO	FLOAT32
<b>41220</b>	1219	IRMS HARMONIC 9 [%] LSW			RO	
<b>41221</b>	1220	IRMS HARMONIC 10 [%] MSW	L1	Measurement of the Phase - Neutral current of the i-th harmonic in comparison with the fundamental [%]	RO	FLOAT32
<b>41222</b>	1221	IRMS HARMONIC 10 [%] LSW			RO	
<b>41223</b>	1222	IRMS HARMONIC 10 [%] MSW	L2	Measurement of the Phase - Neutral current of the i-th harmonic in comparison with the fundamental [%]	RO	FLOAT32
<b>41224</b>	1223	IRMS HARMONIC 10 [%] LSW			RO	
<b>41225</b>	1224	IRMS HARMONIC 10 [%] MSW	L3		RO	FLOAT32



ADDRESS (4x)	ADDRESS OFFSET	REGISTER	PHASE	DESCRIPTION	W/R	TYPE
41226	1225	IRMS HARMONIC 10 [%] LSW		Measurement of the Phase - Neutral current of the i-th harmonic in comparison with the fundamental [%]	RO	
41227	1226	IRMS HARMONIC 11 [%] MSW	L1	Measurement of the Phase - Neutral current of the i-th harmonic in comparison with the fundamental [%]	RO	FLOAT32
41228	1227	IRMS HARMONIC 11 [%] LSW			RO	
41229	1228	IRMS HARMONIC 11 [%] MSW	L2	Measurement of the Phase - Neutral current of the i-th harmonic in comparison with the fundamental [%]	RO	FLOAT32
41230	1229	IRMS HARMONIC 11 [%] LSW			RO	
41231	1230	IRMS HARMONIC 11 [%] MSW	L3	Measurement of the Phase - Neutral current of the i-th harmonic in comparison with the fundamental [%]	RO	FLOAT32
41232	1231	IRMS HARMONIC 11 [%] LSW			RO	
41233	1232	IRMS HARMONIC 12 [%] MSW	L1	Measurement of the Phase - Neutral current of the i-th harmonic in comparison with the fundamental [%]	RO	FLOAT32
41234	1233	IRMS HARMONIC 12 [%] LSW			RO	
41235	1234	IRMS HARMONIC 12 [%] MSW	L2	Measurement of the Phase - Neutral current of the i-th harmonic in comparison with the fundamental [%]	RO	FLOAT32
41236	1235	IRMS HARMONIC 12 [%] LSW			RO	
41237	1236	IRMS HARMONIC 12 [%] MSW	L3	Measurement of the Phase - Neutral current of the i-th harmonic in comparison with the fundamental [%]	RO	FLOAT32
41238	1237	IRMS HARMONIC 12 [%] LSW			RO	
41239	1238	IRMS HARMONIC 13 [%] MSW	L1	Measurement of the Phase - Neutral current of the i-th harmonic in comparison with the fundamental [%]	RO	FLOAT32
41240	1239	IRMS HARMONIC 13 [%] LSW			RO	
41241	1240	IRMS HARMONIC 13 [%] MSW	L2	Measurement of the Phase - Neutral current of the i-th harmonic in	RO	FLOAT32
41242	1241	IRMS HARMONIC 13 [%] LSW			RO	

ADDRESS (4x)	ADDRESS OFFSET	REGISTER	PHASE	DESCRIPTION	W/R	TYPE
				comparison with the fundamental [%]		
<b>41243</b>	1242	IRMS HARMONIC 13 [%] MSW	L3	Measurement of the Phase - Neutral current of the i-th harmonic in comparison with the fundamental [%]	RO	FLOAT32
<b>41244</b>	1243	IRMS HARMONIC 13 [%] LSW			RO	
<b>41245</b>	1244	IRMS HARMONIC 14 [%] MSW	L1	Measurement of the Phase - Neutral current of the i-th harmonic in comparison with the fundamental [%]	RO	FLOAT32
<b>41246</b>	1245	IRMS HARMONIC 14 [%] LSW			RO	
<b>41247</b>	1246	IRMS HARMONIC 14 [%] MSW	L2	Measurement of the Phase - Neutral current of the i-th harmonic in comparison with the fundamental [%]	RO	FLOAT32
<b>41248</b>	1247	IRMS HARMONIC 14 [%] LSW			RO	
<b>41249</b>	1248	IRMS HARMONIC 14 [%] MSW	L3	Measurement of the Phase - Neutral current of the i-th harmonic in comparison with the fundamental [%]	RO	FLOAT32
<b>41250</b>	1249	IRMS HARMONIC 14 [%] LSW			RO	
<b>41251</b>	1250	IRMS HARMONIC 15 [%] MSW	L1	Measurement of the Phase - Neutral current of the i-th harmonic in comparison with the fundamental [%]	RO	FLOAT32
<b>41252</b>	1251	IRMS HARMONIC 15 [%] LSW			RO	
<b>41253</b>	1252	IRMS HARMONIC 15 [%] MSW	L2	Measurement of the Phase - Neutral current of the i-th harmonic in comparison with the fundamental [%]	RO	FLOAT32
<b>41254</b>	1253	IRMS HARMONIC 15 [%] LSW			RO	
<b>41255</b>	1254	IRMS HARMONIC 15 [%] MSW	L3	Measurement of the Phase - Neutral current of the i-th harmonic in comparison with the fundamental [%]	RO	FLOAT32
<b>41256</b>	1255	IRMS HARMONIC 15 [%] LSW			RO	
<b>41257</b>	1256	IRMS HARMONIC 16 [%] MSW	L1	Measurement of the Phase - Neutral current of the i-th harmonic in comparison with the fundamental [%]	RO	FLOAT32
<b>41258</b>	1257	IRMS HARMONIC 16 [%] LSW			RO	
<b>41259</b>	1258	IRMS HARMONIC 16 [%] MSW	L2	Measurement of the Phase - Neutral current	RO	FLOAT32
<b>41260</b>	1259	IRMS HARMONIC 16 [%] LSW			RO	

ADDRESS (4x)	ADDRESS OFFSET	REGISTER	PHASE	DESCRIPTION	W/R	TYPE
				of the i-th harmonic in comparison with the fundamental [%]		
<b>41261</b>	1260	IRMS HARMONIC 16 [%] MSW	L3	Measurement of the Phase - Neutral current of the i-th harmonic in comparison with the fundamental [%]	RO	FLOAT32
<b>41262</b>	1261	IRMS HARMONIC 16 [%] LSW			RO	
<b>41263</b>	1262	IRMS HARMONIC 17 [%] MSW	L1	Measurement of the Phase - Neutral current of the i-th harmonic in comparison with the fundamental [%]	RO	FLOAT32
<b>41264</b>	1263	IRMS HARMONIC 17 [%] LSW			RO	
<b>41265</b>	1264	IRMS HARMONIC 17 [%] MSW	L2	Measurement of the Phase - Neutral current of the i-th harmonic in comparison with the fundamental [%]	RO	FLOAT32
<b>41266</b>	1265	IRMS HARMONIC 17 [%] LSW			RO	
<b>41267</b>	1266	IRMS HARMONIC 17 [%] MSW	L3	Measurement of the Phase - Neutral current of the i-th harmonic in comparison with the fundamental [%]	RO	FLOAT32
<b>41268</b>	1267	IRMS HARMONIC 17 [%] LSW			RO	
<b>41269</b>	1268	IRMS HARMONIC 18 [%] MSW	L1	Measurement of the Phase - Neutral current of the i-th harmonic in comparison with the fundamental [%]	RO	FLOAT32
<b>41270</b>	1269	IRMS HARMONIC 18 [%] LSW			RO	
<b>41271</b>	1270	IRMS HARMONIC 18 [%] MSW	L2	Measurement of the Phase - Neutral current of the i-th harmonic in comparison with the fundamental [%]	RO	FLOAT32
<b>41272</b>	1271	IRMS HARMONIC 18 [%] LSW			RO	
<b>41273</b>	1272	IRMS HARMONIC 18 [%] MSW	L3	Measurement of the Phase - Neutral current of the i-th harmonic in comparison with the fundamental [%]	RO	FLOAT32
<b>41274</b>	1273	IRMS HARMONIC 18 [%] LSW			RO	
<b>41275</b>	1274	IRMS HARMONIC 19 [%] MSW	L1	Measurement of the Phase - Neutral current of the i-th harmonic in comparison with the fundamental [%]	RO	FLOAT32
<b>41276</b>	1275	IRMS HARMONIC 19 [%] LSW			RO	
<b>41277</b>	1276	IRMS HARMONIC 19 [%] MSW	L2		RO	FLOAT32

ADDRESS (4x)	ADDRESS OFFSET	REGISTER	PHASE	DESCRIPTION	W/R	TYPE
41278	1277	IRMS HARMONIC 19 [%] LSW		Measurement of the Phase - Neutral current of the i-th harmonic in comparison with the fundamental [%]	RO	
41279	1278	IRMS HARMONIC 19 [%] MSW	L3	Measurement of the Phase - Neutral current of the i-th harmonic in comparison with the fundamental [%]	RO	FLOAT32
41280	1279	IRMS HARMONIC 19 [%] LSW			RO	
41281	1280	IRMS HARMONIC 20 [%] MSW	L1	Measurement of the Phase - Neutral current of the i-th harmonic in comparison with the fundamental [%]	RO	FLOAT32
41282	1281	IRMS HARMONIC 20 [%] LSW			RO	
41283	1282	IRMS HARMONIC 20 [%] MSW	L2	Measurement of the Phase - Neutral current of the i-th harmonic in comparison with the fundamental [%]	RO	FLOAT32
41284	1283	IRMS HARMONIC 20 [%] LSW			RO	
41285	1284	IRMS HARMONIC 20 [%] MSW	L3	Measurement of the Phase - Neutral current of the i-th harmonic in comparison with the fundamental [%]	RO	FLOAT32
41286	1285	IRMS HARMONIC 20 [%] LSW			RO	
41287	1286	IRMS HARMONIC 21 [%] MSW	L1	Measurement of the Phase - Neutral current of the i-th harmonic in comparison with the fundamental [%]	RO	FLOAT32
41288	1287	IRMS HARMONIC 21 [%] LSW			RO	
41289	1288	IRMS HARMONIC 21 [%] MSW	L2	Measurement of the Phase - Neutral current of the i-th harmonic in comparison with the fundamental [%]	RO	FLOAT32
41290	1289	IRMS HARMONIC 21 [%] LSW			RO	
41291	1290	IRMS HARMONIC 21 [%] MSW	L3	Measurement of the Phase - Neutral current of the i-th harmonic in comparison with the fundamental [%]	RO	FLOAT32
41292	1291	IRMS HARMONIC 21 [%] LSW			RO	
41293	1292	IRMS HARMONIC 22 [%] MSW	L1	Measurement of the Phase - Neutral current of the i-th harmonic in	RO	FLOAT32
41294	1293	IRMS HARMONIC 22 [%] LSW			RO	

ADDRESS (4x)	ADDRESS OFFSET	REGISTER	PHASE	DESCRIPTION	W/R	TYPE
				comparison with the fundamental [%]		
<b>41295</b>	1294	IRMS HARMONIC 22 [%] MSW	L2	Measurement of the Phase - Neutral current of the i-th harmonic in comparison with the fundamental [%]	RO	FLOAT32
<b>41296</b>	1295	IRMS HARMONIC 22 [%] LSW			RO	
<b>41297</b>	1296	IRMS HARMONIC 22 [%] MSW	L3	Measurement of the Phase - Neutral current of the i-th harmonic in comparison with the fundamental [%]	RO	FLOAT32
<b>41298</b>	1297	IRMS HARMONIC 22 [%] LSW			RO	
<b>41299</b>	1298	IRMS HARMONIC 23 [%] MSW	L1	Measurement of the Phase - Neutral current of the i-th harmonic in comparison with the fundamental [%]	RO	FLOAT32
<b>41300</b>	1299	IRMS HARMONIC 23 [%] LSW			RO	
<b>41301</b>	1300	IRMS HARMONIC 23 [%] MSW	L2	Measurement of the Phase - Neutral current of the i-th harmonic in comparison with the fundamental [%]	RO	FLOAT32
<b>41302</b>	1301	IRMS HARMONIC 23 [%] LSW			RO	
<b>41303</b>	1302	IRMS HARMONIC 23 [%] MSW	L3	Measurement of the Phase - Neutral current of the i-th harmonic in comparison with the fundamental [%]	RO	FLOAT32
<b>41304</b>	1303	IRMS HARMONIC 23 [%] LSW			RO	
<b>41305</b>	1304	IRMS HARMONIC 24 [%] MSW	L1	Measurement of the Phase - Neutral current of the i-th harmonic in comparison with the fundamental [%]	RO	FLOAT32
<b>41306</b>	1305	IRMS HARMONIC 24 [%] LSW			RO	
<b>41307</b>	1306	IRMS HARMONIC 24 [%] MSW	L2	Measurement of the Phase - Neutral current of the i-th harmonic in comparison with the fundamental [%]	RO	FLOAT32
<b>41308</b>	1307	IRMS HARMONIC 24 [%] LSW			RO	
<b>41309</b>	1308	IRMS HARMONIC 24 [%] MSW	L3	Measurement of the Phase - Neutral current of the i-th harmonic in comparison with the fundamental [%]	RO	FLOAT32
<b>41310</b>	1309	IRMS HARMONIC 24 [%] LSW			RO	
<b>41311</b>	1310	IRMS HARMONIC 25 [%] MSW	L1	Measurement of the Phase - Neutral current	RO	FLOAT32
<b>41312</b>	1311	IRMS HARMONIC 25 [%] LSW			RO	

ADDRESS (4x)	ADDRESS OFFSET	REGISTER	PHASE	DESCRIPTION	W/R	TYPE
				of the i-th harmonic in comparison with the fundamental [%]		
<b>41313</b>	1312	IRMS HARMONIC 25 [%] MSW	L2	Measurement of the Phase - Neutral current of the i-th harmonic in comparison with the fundamental [%]	RO	FLOAT32
<b>41314</b>	1313	IRMS HARMONIC 25 [%] LSW			RO	
<b>41315</b>	1314	IRMS HARMONIC 25 [%] MSW	L3	Measurement of the Phase - Neutral current of the i-th harmonic in comparison with the fundamental [%]	RO	FLOAT32
<b>41316</b>	1315	IRMS HARMONIC 25 [%] LSW			RO	
<b>41317</b>	1316	IRMS HARMONIC 26 [%] MSW	L1	Measurement of the Phase - Neutral current of the i-th harmonic in comparison with the fundamental [%]	RO	FLOAT32
<b>41318</b>	1317	IRMS HARMONIC 26 [%] LSW			RO	
<b>41319</b>	1318	IRMS HARMONIC 26 [%] MSW	L2	Measurement of the Phase - Neutral current of the i-th harmonic in comparison with the fundamental [%]	RO	FLOAT32
<b>41320</b>	1319	IRMS HARMONIC 26 [%] LSW			RO	
<b>41321</b>	1320	IRMS HARMONIC 26 [%] MSW	L3	Measurement of the Phase - Neutral current of the i-th harmonic in comparison with the fundamental [%]	RO	FLOAT32
<b>41322</b>	1321	IRMS HARMONIC 26 [%] LSW			RO	
<b>41323</b>	1322	IRMS HARMONIC 27 [%] MSW	L1	Measurement of the Phase - Neutral current of the i-th harmonic in comparison with the fundamental [%]	RO	FLOAT32
<b>41324</b>	1323	IRMS HARMONIC 27 [%] LSW			RO	
<b>41325</b>	1324	IRMS HARMONIC 27 [%] MSW	L2	Measurement of the Phase - Neutral current of the i-th harmonic in comparison with the fundamental [%]	RO	FLOAT32
<b>41326</b>	1325	IRMS HARMONIC 27 [%] LSW			RO	
<b>41327</b>	1326	IRMS HARMONIC 27 [%] MSW	L3	Measurement of the Phase - Neutral current of the i-th harmonic in comparison with the fundamental [%]	RO	FLOAT32
<b>41328</b>	1327	IRMS HARMONIC 27 [%] LSW			RO	
<b>41329</b>	1328	IRMS HARMONIC 28 [%] MSW	L1		RO	FLOAT32

ADDRESS (4x)	ADDRESS OFFSET	REGISTER	PHASE	DESCRIPTION	W/R	TYPE
41330	1329	IRMS HARMONIC 28 [%] LSW		Measurement of the Phase - Neutral current of the i-th harmonic in comparison with the fundamental [%]	RO	
41331	1330	IRMS HARMONIC 28 [%] MSW	L2	Measurement of the Phase - Neutral current of the i-th harmonic in comparison with the fundamental [%]	RO	FLOAT32
41332	1331	IRMS HARMONIC 28 [%] LSW			RO	
41333	1332	IRMS HARMONIC 28 [%] MSW	L3	Measurement of the Phase - Neutral current of the i-th harmonic in comparison with the fundamental [%]	RO	FLOAT32
41334	1333	IRMS HARMONIC 28 [%] LSW			RO	
41335	1334	IRMS HARMONIC 29 [%] MSW	L1	Measurement of the Phase - Neutral current of the i-th harmonic in comparison with the fundamental [%]	RO	FLOAT32
41336	1335	IRMS HARMONIC 29 [%] LSW			RO	
41337	1336	IRMS HARMONIC 29 [%] MSW	L2	Measurement of the Phase - Neutral current of the i-th harmonic in comparison with the fundamental [%]	RO	FLOAT32
41338	1337	IRMS HARMONIC 29 [%] LSW			RO	
41339	1338	IRMS HARMONIC 29 [%] MSW	L3	Measurement of the Phase - Neutral current of the i-th harmonic in comparison with the fundamental [%]	RO	FLOAT32
41340	1339	IRMS HARMONIC 29 [%] LSW			RO	
41341	1340	IRMS HARMONIC 30 [%] MSW	L1	Measurement of the Phase - Neutral current of the i-th harmonic in comparison with the fundamental [%]	RO	FLOAT32
41342	1341	IRMS HARMONIC 30 [%] LSW			RO	
41343	1342	IRMS HARMONIC 30 [%] MSW	L2	Measurement of the Phase - Neutral current of the i-th harmonic in comparison with the fundamental [%]	RO	FLOAT32
41344	1343	IRMS HARMONIC 30 [%] LSW			RO	
41345	1344	IRMS HARMONIC 30 [%] MSW	L3	Measurement of the Phase - Neutral current of the i-th harmonic in	RO	FLOAT32
41346	1345	IRMS HARMONIC 30 [%] LSW			RO	

ADDRESS (4x)	ADDRESS OFFSET	REGISTER	PHASE	DESCRIPTION	W/R	TYPE
				comparison with the fundamental [%]		
<b>41347</b>	1346	IRMS HARMONIC 31 [%] MSW	L1	Measurement of the Phase - Neutral current of the i-th harmonic in comparison with the fundamental [%]	RO	FLOAT32
<b>41348</b>	1347	IRMS HARMONIC 31 [%] LSW			RO	
<b>41349</b>	1348	IRMS HARMONIC 31 [%] MSW	L2	Measurement of the Phase - Neutral current of the i-th harmonic in comparison with the fundamental [%]	RO	FLOAT32
<b>41350</b>	1349	IRMS HARMONIC 31 [%] LSW			RO	
<b>41351</b>	1350	IRMS HARMONIC 31 [%] MSW	L3	Measurement of the Phase - Neutral current of the i-th harmonic in comparison with the fundamental [%]	RO	FLOAT32
<b>41352</b>	1351	IRMS HARMONIC 31 [%] LSW			RO	
<b>41353</b>	1352	IRMS HARMONIC 32 [%] MSW	L1	Measurement of the Phase - Neutral current of the i-th harmonic in comparison with the fundamental [%]	RO	FLOAT32
<b>41354</b>	1353	IRMS HARMONIC 32 [%] LSW			RO	
<b>41355</b>	1354	IRMS HARMONIC 32 [%] MSW	L2	Measurement of the Phase - Neutral current of the i-th harmonic in comparison with the fundamental [%]	RO	FLOAT32
<b>41356</b>	1355	IRMS HARMONIC 32 [%] LSW			RO	
<b>41357</b>	1356	IRMS HARMONIC 32 [%] MSW	L3	Measurement of the Phase - Neutral current of the i-th harmonic in comparison with the fundamental [%]	RO	FLOAT32
<b>41358</b>	1357	IRMS HARMONIC 32 [%] LSW			RO	
<b>41359</b>	1358	IRMS HARMONIC 33 [%] MSW	L1	Measurement of the Phase - Neutral current of the i-th harmonic in comparison with the fundamental [%]	RO	FLOAT32
<b>41360</b>	1359	IRMS HARMONIC 33 [%] LSW			RO	
<b>41361</b>	1360	IRMS HARMONIC 33 [%] MSW	L2	Measurement of the Phase - Neutral current of the i-th harmonic in comparison with the fundamental [%]	RO	FLOAT32
<b>41362</b>	1361	IRMS HARMONIC 33 [%] LSW			RO	
<b>41363</b>	1362	IRMS HARMONIC 33 [%] MSW	L3	Measurement of the Phase - Neutral current	RO	FLOAT32
<b>41364</b>	1363	IRMS HARMONIC 33 [%] LSW			RO	



ADDRESS (4x)	ADDRESS OFFSET	REGISTER	PHASE	DESCRIPTION	W/R	TYPE
				of the i-th harmonic in comparison with the fundamental [%]		
<b>41365</b>	1364	IRMS HARMONIC 34 [%] MSW	L1	Measurement of the Phase - Neutral current of the i-th harmonic in comparison with the fundamental [%]	RO	FLOAT32
<b>41366</b>	1365	IRMS HARMONIC 34 [%] LSW			RO	
<b>41367</b>	1366	IRMS HARMONIC 34 [%] MSW	L2	Measurement of the Phase - Neutral current of the i-th harmonic in comparison with the fundamental [%]	RO	FLOAT32
<b>41368</b>	1367	IRMS HARMONIC 34 [%] LSW			RO	
<b>41369</b>	1368	IRMS HARMONIC 34 [%] MSW	L3	Measurement of the Phase - Neutral current of the i-th harmonic in comparison with the fundamental [%]	RO	FLOAT32
<b>41370</b>	1369	IRMS HARMONIC 34 [%] LSW			RO	
<b>41371</b>	1370	IRMS HARMONIC 35 [%] MSW	L1	Measurement of the Phase - Neutral current of the i-th harmonic in comparison with the fundamental [%]	RO	FLOAT32
<b>41372</b>	1371	IRMS HARMONIC 35 [%] LSW			RO	
<b>41373</b>	1372	IRMS HARMONIC 35 [%] MSW	L2	Measurement of the Phase - Neutral current of the i-th harmonic in comparison with the fundamental [%]	RO	FLOAT32
<b>41374</b>	1373	IRMS HARMONIC 35 [%] LSW			RO	
<b>41375</b>	1374	IRMS HARMONIC 35 [%] MSW	L3	Measurement of the Phase - Neutral current of the i-th harmonic in comparison with the fundamental [%]	RO	FLOAT32
<b>41376</b>	1375	IRMS HARMONIC 35 [%] LSW			RO	
<b>41377</b>	1376	IRMS HARMONIC 36 [%] MSW	L1	Measurement of the Phase - Neutral current of the i-th harmonic in comparison with the fundamental [%]	RO	FLOAT32
<b>41378</b>	1377	IRMS HARMONIC 36 [%] LSW			RO	
<b>41379</b>	1378	IRMS HARMONIC 36 [%] MSW	L2	Measurement of the Phase - Neutral current of the i-th harmonic in comparison with the fundamental [%]	RO	FLOAT32
<b>41380</b>	1379	IRMS HARMONIC 36 [%] LSW			RO	
<b>41381</b>	1380	IRMS HARMONIC 36 [%] MSW	L3		RO	FLOAT32

ADDRESS (4x)	ADDRESS OFFSET	REGISTER	PHASE	DESCRIPTION	W/R	TYPE
41382	1381	IRMS HARMONIC 36 [%] LSW		Measurement of the Phase - Neutral current of the i-th harmonic in comparison with the fundamental [%]	RO	
41383	1382	IRMS HARMONIC 37 [%] MSW	L1	Measurement of the Phase - Neutral current of the i-th harmonic in comparison with the fundamental [%]	RO	FLOAT32
41384	1383	IRMS HARMONIC 37 [%] LSW			RO	
41385	1384	IRMS HARMONIC 37 [%] MSW	L2	Measurement of the Phase - Neutral current of the i-th harmonic in comparison with the fundamental [%]	RO	FLOAT32
41386	1385	IRMS HARMONIC 37 [%] LSW			RO	
41387	1386	IRMS HARMONIC 37 [%] MSW	L3	Measurement of the Phase - Neutral current of the i-th harmonic in comparison with the fundamental [%]	RO	FLOAT32
41388	1387	IRMS HARMONIC 37 [%] LSW			RO	
41389	1388	IRMS HARMONIC 38 [%] MSW	L1	Measurement of the Phase - Neutral current of the i-th harmonic in comparison with the fundamental [%]	RO	FLOAT32
41390	1389	IRMS HARMONIC 38 [%] LSW			RO	
41391	1390	IRMS HARMONIC 38 [%] MSW	L2	Measurement of the Phase - Neutral current of the i-th harmonic in comparison with the fundamental [%]	RO	FLOAT32
41392	1391	IRMS HARMONIC 38 [%] LSW			RO	
41393	1392	IRMS HARMONIC 38 [%] MSW	L3	Measurement of the Phase - Neutral current of the i-th harmonic in comparison with the fundamental [%]	RO	FLOAT32
41394	1393	IRMS HARMONIC 38 [%] LSW			RO	
41395	1394	IRMS HARMONIC 39 [%] MSW	L1	Measurement of the Phase - Neutral current of the i-th harmonic in comparison with the fundamental [%]	RO	FLOAT32
41396	1395	IRMS HARMONIC 39 [%] LSW			RO	
41397	1396	IRMS HARMONIC 39 [%] MSW	L2	Measurement of the Phase - Neutral current of the i-th harmonic in	RO	FLOAT32
41398	1397	IRMS HARMONIC 39 [%] LSW			RO	

ADDRESS (4x)	ADDRESS OFFSET	REGISTER	PHASE	DESCRIPTION	W/R	TYPE
				comparison with the fundamental [%]		
<b>41399</b>	1398	IRMS HARMONIC 39 [%] MSW	L3	Measurement of the Phase - Neutral current of the i-th harmonic in comparison with the fundamental [%]	RO	FLOAT32
<b>41400</b>	1399	IRMS HARMONIC 39 [%] LSW			RO	
<b>41401</b>	1400	IRMS HARMONIC 40 [%] MSW	L1	Measurement of the Phase - Neutral current of the i-th harmonic in comparison with the fundamental [%]	RO	FLOAT32
<b>41402</b>	1401	IRMS HARMONIC 40 [%] LSW			RO	
<b>41403</b>	1402	IRMS HARMONIC 40 [%] MSW	L2	Measurement of the Phase - Neutral current of the i-th harmonic in comparison with the fundamental [%]	RO	FLOAT32
<b>41404</b>	1403	IRMS HARMONIC 40 [%] LSW			RO	
<b>41405</b>	1404	IRMS HARMONIC 40 [%] MSW	L3	Measurement of the Phase - Neutral current of the i-th harmonic in comparison with the fundamental [%]	RO	FLOAT32
<b>41406</b>	1405	IRMS HARMONIC 40 [%] LSW			RO	
<b>41407</b>	1406	IRMS HARMONIC 41 [%] MSW	L1	Measurement of the Phase - Neutral current of the i-th harmonic in comparison with the fundamental [%]	RO	FLOAT32
<b>41408</b>	1407	IRMS HARMONIC 41 [%] LSW			RO	
<b>41409</b>	1408	IRMS HARMONIC 41 [%] MSW	L2	Measurement of the Phase - Neutral current of the i-th harmonic in comparison with the fundamental [%]	RO	FLOAT32
<b>41410</b>	1409	IRMS HARMONIC 41 [%] LSW			RO	
<b>41411</b>	1410	IRMS HARMONIC 41 [%] MSW	L3	Measurement of the Phase - Neutral current of the i-th harmonic in comparison with the fundamental [%]	RO	FLOAT32
<b>41412</b>	1411	IRMS HARMONIC 41 [%] LSW			RO	
<b>41413</b>	1412	IRMS HARMONIC 42 [%] MSW	L1	Measurement of the Phase - Neutral current of the i-th harmonic in comparison with the fundamental [%]	RO	FLOAT32
<b>41414</b>	1413	IRMS HARMONIC 42 [%] LSW			RO	
<b>41415</b>	1414	IRMS HARMONIC 42 [%] MSW	L2	Measurement of the Phase - Neutral current	RO	FLOAT32
<b>41416</b>	1415	IRMS HARMONIC 42 [%] LSW			RO	

ADDRESS (4x)	ADDRESS OFFSET	REGISTER	PHASE	DESCRIPTION	W/R	TYPE
				of the i-th harmonic in comparison with the fundamental [%]		
<b>41417</b>	1416	IRMS HARMONIC 42 [%] MSW	L3	Measurement of the Phase - Neutral current of the i-th harmonic in comparison with the fundamental [%]	RO	FLOAT32
<b>41418</b>	1417	IRMS HARMONIC 42 [%] LSW			RO	
<b>41419</b>	1418	IRMS HARMONIC 43 [%] MSW	L1	Measurement of the Phase - Neutral current of the i-th harmonic in comparison with the fundamental [%]	RO	FLOAT32
<b>41420</b>	1419	IRMS HARMONIC 43 [%] LSW			RO	
<b>41421</b>	1420	IRMS HARMONIC 43 [%] MSW	L2	Measurement of the Phase - Neutral current of the i-th harmonic in comparison with the fundamental [%]	RO	FLOAT32
<b>41422</b>	1421	IRMS HARMONIC 43 [%] LSW			RO	
<b>41423</b>	1422	IRMS HARMONIC 43 [%] MSW	L3	Measurement of the Phase - Neutral current of the i-th harmonic in comparison with the fundamental [%]	RO	FLOAT32
<b>41424</b>	1423	IRMS HARMONIC 43 [%] LSW			RO	
<b>41425</b>	1424	IRMS HARMONIC 44 [%] MSW	L1	Measurement of the Phase - Neutral current of the i-th harmonic in comparison with the fundamental [%]	RO	FLOAT32
<b>41426</b>	1425	IRMS HARMONIC 44 [%] LSW			RO	
<b>41427</b>	1426	IRMS HARMONIC 44 [%] MSW	L2	Measurement of the Phase - Neutral current of the i-th harmonic in comparison with the fundamental [%]	RO	FLOAT32
<b>41428</b>	1427	IRMS HARMONIC 44 [%] LSW			RO	
<b>41429</b>	1428	IRMS HARMONIC 44 [%] MSW	L3	Measurement of the Phase - Neutral current of the i-th harmonic in comparison with the fundamental [%]	RO	FLOAT32
<b>41430</b>	1429	IRMS HARMONIC 44 [%] LSW			RO	
<b>41431</b>	1430	IRMS HARMONIC 45 [%] MSW	L1	Measurement of the Phase - Neutral current of the i-th harmonic in comparison with the fundamental [%]	RO	FLOAT32
<b>41432</b>	1431	IRMS HARMONIC 45 [%] LSW			RO	
<b>41433</b>	1432	IRMS HARMONIC 45 [%] MSW	L2		RO	FLOAT32

ADDRESS (4x)	ADDRESS OFFSET	REGISTER	PHASE	DESCRIPTION	W/R	TYPE
41434	1433	IRMS HARMONIC 45 [%] LSW		Measurement of the Phase - Neutral current of the i-th harmonic in comparison with the fundamental [%]	RO	
41435	1434	IRMS HARMONIC 45 [%] MSW	L3	Measurement of the Phase - Neutral current of the i-th harmonic in comparison with the fundamental [%]	RO	FLOAT32
41436	1435	IRMS HARMONIC 45 [%] LSW			RO	
41437	1436	IRMS HARMONIC 46 [%] MSW	L1	Measurement of the Phase - Neutral current of the i-th harmonic in comparison with the fundamental [%]	RO	FLOAT32
41438	1437	IRMS HARMONIC 46 [%] LSW			RO	
41439	1438	IRMS HARMONIC 46 [%] MSW	L2	Measurement of the Phase - Neutral current of the i-th harmonic in comparison with the fundamental [%]	RO	FLOAT32
41440	1439	IRMS HARMONIC 46 [%] LSW			RO	
41441	1440	IRMS HARMONIC 46 [%] MSW	L3	Measurement of the Phase - Neutral current of the i-th harmonic in comparison with the fundamental [%]	RO	FLOAT32
41442	1441	IRMS HARMONIC 46 [%] LSW			RO	
41443	1442	IRMS HARMONIC 47 [%] MSW	L1	Measurement of the Phase - Neutral current of the i-th harmonic in comparison with the fundamental [%]	RO	FLOAT32
41444	1443	IRMS HARMONIC 47 [%] LSW			RO	
41445	1444	IRMS HARMONIC 47 [%] MSW	L2	Measurement of the Phase - Neutral current of the i-th harmonic in comparison with the fundamental [%]	RO	FLOAT32
41446	1445	IRMS HARMONIC 47 [%] LSW			RO	
41447	1446	IRMS HARMONIC 47 [%] MSW	L3	Measurement of the Phase - Neutral current of the i-th harmonic in comparison with the fundamental [%]	RO	FLOAT32
41448	1447	IRMS HARMONIC 47 [%] LSW			RO	
41449	1448	IRMS HARMONIC 48 [%] MSW	L1	Measurement of the Phase - Neutral current of the i-th harmonic in	RO	FLOAT32
41450	1449	IRMS HARMONIC 48 [%] LSW			RO	

ADDRESS (4x)	ADDRESS OFFSET	REGISTER	PHASE	DESCRIPTION	W/R	TYPE
				comparison with the fundamental [%]		
<b>41451</b>	1450	IRMS HARMONIC 48 [%] MSW	L2	Measurement of the Phase - Neutral current of the i-th harmonic in comparison with the fundamental [%]	RO	FLOAT32
<b>41452</b>	1451	IRMS HARMONIC 48 [%] LSW			RO	
<b>41453</b>	1452	IRMS HARMONIC 48 [%] MSW	L3	Measurement of the Phase - Neutral current of the i-th harmonic in comparison with the fundamental [%]	RO	FLOAT32
<b>41454</b>	1453	IRMS HARMONIC 48 [%] LSW			RO	
<b>41455</b>	1454	IRMS HARMONIC 49 [%] MSW	L1	Measurement of the Phase - Neutral current of the i-th harmonic in comparison with the fundamental [%]	RO	FLOAT32
<b>41456</b>	1455	IRMS HARMONIC 49 [%] LSW			RO	
<b>41457</b>	1456	IRMS HARMONIC 49 [%] MSW	L2	Measurement of the Phase - Neutral current of the i-th harmonic in comparison with the fundamental [%]	RO	FLOAT32
<b>41458</b>	1457	IRMS HARMONIC 49 [%] LSW			RO	
<b>41459</b>	1458	IRMS HARMONIC 49 [%] MSW	L3	Measurement of the Phase - Neutral current of the i-th harmonic in comparison with the fundamental [%]	RO	FLOAT32
<b>41460</b>	1459	IRMS HARMONIC 49 [%] LSW			RO	
<b>41461</b>	1460	IRMS HARMONIC 50 [%] MSW	L1	Measurement of the Phase - Neutral current of the i-th harmonic in comparison with the fundamental [%]	RO	FLOAT32
<b>41462</b>	1461	IRMS HARMONIC 50 [%] LSW			RO	
<b>41463</b>	1462	IRMS HARMONIC 50 [%] MSW	L2	Measurement of the Phase - Neutral current of the i-th harmonic in comparison with the fundamental [%]	RO	FLOAT32
<b>41464</b>	1463	IRMS HARMONIC 50 [%] LSW			RO	
<b>41465</b>	1464	IRMS HARMONIC 50 [%] MSW	L3	Measurement of the Phase - Neutral current of the i-th harmonic in comparison with the fundamental [%]	RO	FLOAT32
<b>41466</b>	1465	IRMS HARMONIC 50 [%] LSW			RO	
<b>41467</b>	1466	IRMS HARMONIC 51 [%] MSW	L1	Measurement of the Phase - Neutral current	RO	FLOAT32
<b>41468</b>	1467	IRMS HARMONIC 51 [%] LSW			RO	

ADDRESS (4x)	ADDRESS OFFSET	REGISTER	PHASE	DESCRIPTION	W/R	TYPE
				of the i-th harmonic in comparison with the fundamental [%]		
<b>41469</b>	1468	IRMS HARMONIC 51 [%] MSW	L2	Measurement of the Phase - Neutral current of the i-th harmonic in comparison with the fundamental [%]	RO	FLOAT32
<b>41470</b>	1469	IRMS HARMONIC 51 [%] LSW			RO	
<b>41471</b>	1470	IRMS HARMONIC 51 [%] MSW	L3	Measurement of the Phase - Neutral current of the i-th harmonic in comparison with the fundamental [%]	RO	FLOAT32
<b>41472</b>	1471	IRMS HARMONIC 51 [%] LSW			RO	
<b>41473</b>	1472	IRMS HARMONIC 52 [%] MSW	L1	Measurement of the Phase - Neutral current of the i-th harmonic in comparison with the fundamental [%]	RO	FLOAT32
<b>41474</b>	1473	IRMS HARMONIC 52 [%] LSW			RO	
<b>41475</b>	1474	IRMS HARMONIC 52 [%] MSW	L2	Measurement of the Phase - Neutral current of the i-th harmonic in comparison with the fundamental [%]	RO	FLOAT32
<b>41476</b>	1475	IRMS HARMONIC 52 [%] LSW			RO	
<b>41477</b>	1476	IRMS HARMONIC 52 [%] MSW	L3	Measurement of the Phase - Neutral current of the i-th harmonic in comparison with the fundamental [%]	RO	FLOAT32
<b>41478</b>	1477	IRMS HARMONIC 52 [%] LSW			RO	
<b>41479</b>	1478	IRMS HARMONIC 53 [%] MSW	L1	Measurement of the Phase - Neutral current of the i-th harmonic in comparison with the fundamental [%]	RO	FLOAT32
<b>41480</b>	1479	IRMS HARMONIC 53 [%] LSW			RO	
<b>41481</b>	1480	IRMS HARMONIC 53 [%] MSW	L2	Measurement of the Phase - Neutral current of the i-th harmonic in comparison with the fundamental [%]	RO	FLOAT32
<b>41482</b>	1481	IRMS HARMONIC 53 [%] LSW			RO	
<b>41483</b>	1482	IRMS HARMONIC 53 [%] MSW	L3	Measurement of the Phase - Neutral current of the i-th harmonic in comparison with the fundamental [%]	RO	FLOAT32
<b>41484</b>	1483	IRMS HARMONIC 53 [%] LSW			RO	
<b>41485</b>	1484	IRMS HARMONIC 54 [%] MSW	L1		RO	FLOAT32

ADDRESS (4x)	ADDRESS OFFSET	REGISTER	PHASE	DESCRIPTION	W/R	TYPE
41486	1485	IRMS HARMONIC 54 [%] LSW		Measurement of the Phase - Neutral current of the i-th harmonic in comparison with the fundamental [%]	RO	
41487	1486	IRMS HARMONIC 54 [%] MSW	L2	Measurement of the Phase - Neutral current of the i-th harmonic in comparison with the fundamental [%]	RO	FLOAT32
41488	1487	IRMS HARMONIC 54 [%] LSW			RO	
41489	1488	IRMS HARMONIC 54 [%] MSW	L3	Measurement of the Phase - Neutral current of the i-th harmonic in comparison with the fundamental [%]	RO	FLOAT32
41490	1489	IRMS HARMONIC 54 [%] LSW			RO	
41491	1490	IRMS HARMONIC 55 [%] MSW	L1	Measurement of the Phase - Neutral current of the i-th harmonic in comparison with the fundamental [%]	RO	FLOAT32
41492	1491	IRMS HARMONIC 55 [%] LSW			RO	
41493	1492	IRMS HARMONIC 55 [%] MSW	L2	Measurement of the Phase - Neutral current of the i-th harmonic in comparison with the fundamental [%]	RO	FLOAT32
41494	1493	IRMS HARMONIC 55 [%] LSW			RO	
41495	1494	IRMS HARMONIC 55 [%] MSW	L3	Measurement of the Phase - Neutral current of the i-th harmonic in comparison with the fundamental [%]	RO	FLOAT32
41496	1495	IRMS HARMONIC 55 [%] LSW			RO	
41497	1496	VRMS AVG [V] MSW	L1	Average VRMS calculated over the configured average time [V]	RO	FLOAT32
41498	1497	VRMS AVG [V] LSW			RO	
41499	1498	VRMS AVG MIN [V] MSW	L1	Minimum VRMS calculated over the configured average time [V]	RW	FLOAT32
41500	1499	VRMS AVG MIN [V] LSW			RW	
41501	1500	VRMS AVG MAX [V] MSW	L1	Maximum VRMS calculated over the configured average time [V]	RW	FLOAT32
41502	1501	VRMS AVG MAX [V] LSW			RW	
41503	1502	VRMS MIN [V] MSW	L1	Device minimum VRMS [V]	RW	FLOAT32
41504	1503	VRMS MIN [V] LSW			RW	
41505	1504	VRMS MAX [V] MSW	L1		RW	FLOAT32



ADDRESS (4x)	ADDRESS OFFSET	REGISTER	PHASE	DESCRIPTION	W/R	TYPE
41506	1505	VRMS MAX [V] LSW		Device maximum VRMS [V]	RW	
41507	1506	VRMS AVG [V] MSW	L2	Average VRMS calculated over the configured average time [V]	RO	FLOAT32
41508	1507	VRMS AVG [V] LSW			RO	
41509	1508	VRMS AVG MIN [V] MSW	L2	Minimum VRMS calculated over the configured average time [V]	RW	FLOAT32
41510	1509	VRMS AVG MIN [V] LSW			RW	
41511	1510	VRMS AVG MAX [V] MSW	L2	Maximum VRMS calculated over the configured average time [V]	RW	FLOAT32
41512	1511	VRMS AVG MAX [V] LSW			RW	
41513	1512	VRMS MIN [V] MSW	L2	Device minimum VRMS [V]	RW	FLOAT32
41514	1513	VRMS MIN [V] LSW			RW	
41515	1514	VRMS MAX [V] MSW	L2	Device maximum VRMS [V]	RW	FLOAT32
41516	1515	VRMS MAX [V] LSW			RW	
41517	1516	VRMS AVG [V] MSW	L3	Average VRMS calculated over the configured average time [V]	RO	FLOAT32
41518	1517	VRMS AVG [V] LSW			RO	
41519	1518	VRMS AVG MIN [V] MSW	L3	Minimum VRMS calculated over the configured average time [V]	RW	FLOAT32
41520	1519	VRMS AVG MIN [V] LSW			RW	
41521	1520	VRMS AVG MAX [V] MSW	L3	Maximum VRMS calculated over the configured average time [V]	RW	FLOAT32
41522	1521	VRMS AVG MAX [V] LSW			RW	
41523	1522	VRMS MIN [V] MSW	L3	Device minimum VRMS [V]	RW	FLOAT32
41524	1523	VRMS MIN [V] LSW			RW	
41525	1524	VRMS MAX [V] MSW	L3	Device maximum VRMS [V]	RW	FLOAT32
41526	1525	VRMS MAX [V] LSW			RW	
41527	1526	IRMS AVG MSW [A]	L1	Average IRMS calculated over the configured average time [A]	RO	FLOAT32
41528	1527	IRMS AVG LSW [A]			RO	
41529	1528	IRMS AVG MIN MSW [A]	L1	Minimum IRMS calculated over the configured average time [A]	RW	FLOAT32
41530	1529	IRMS AVG MIN LSW [A]			RW	
41531	1530	IRMS AVG MAX MSW [A]	L1	Maximum IRMS calculated over the configured average time [A]	RW	FLOAT32
41532	1531	IRMS AVG MAX LSW [A]			RW	
41533	1532	IRMS MIN MSW [A]	L1	Minimum IRMS since device power up [A]	RW	FLOAT32
41534	1533	IRMS MIN LSW [A]			RW	

ADDRESS (4x)	ADDRESS OFFSET	REGISTER	PHASE	DESCRIPTION	W/R	TYPE
41535	1534	IRMS MAX MSW [A]	L1	Device maximum IRMS [A]	RW	FLOAT32
41536	1535	IRMS MAX LSW [A]			RW	
41537	1536	IRMS AVG MSW [A]	L2	Average IRMS calculated over the configured average time [A]	RO	FLOAT32
41538	1537	IRMS AVG LSW [A]			RO	
41539	1538	IRMS AVG MIN MSW [A]	L2	Minimum IRMS calculated over the configured average time [A]	RW	FLOAT32
41540	1539	IRMS AVG MIN LSW [A]			RW	
41541	1540	IRMS AVG MAX MSW [A]	L2	Maximum IRMS calculated over the configured average time [A]	RW	FLOAT32
41542	1541	IRMS AVG MAX LSW [A]			RW	
41543	1542	IRMS MIN MSW [A]	L2	Device minimum IRMS [A]	RW	FLOAT32
41544	1543	IRMS MIN LSW [A]			RW	
41545	1544	IRMS MAX MSW [A]	L2	Maximum IRMS since device power up [A]	RW	FLOAT32
41546	1545	IRMS MAX LSW [A]			RW	
41547	1546	IRMS AVG MSW [A]	L3	Average IRMS calculated over the configured average time [A]	RO	FLOAT32
41548	1547	IRMS AVG LSW [A]			RO	
41549	1548	IRMS AVG MIN MSW [A]	L3	Minimum IRMS calculated over the configured average time [A]	RW	FLOAT32
41550	1549	IRMS AVG MIN LSW [A]			RW	
41551	1550	IRMS AVG MAX MSW [A]	L3	Maximum IRMS calculated over the configured average time [A]	RW	FLOAT32
41552	1551	IRMS AVG MAX LSW [A]			RW	
41553	1552	IRMS MIN MSW [A]	L3	Device minimum IRMS [A]	RW	FLOAT32
41554	1553	IRMS MIN LSW [A]			RW	
41555	1554	IRMS MAX MSW [A]	L3	Device maximum IRMS [A]	RW	FLOAT32
41556	1555	IRMS MAX LSW [A]			RW	
41557	1556	VRMS AVG [V] MSW	L1-L2	Average VRMS calculated over the configured average time [V]	RO	FLOAT32
41558	1557	VRMS AVG [V] LSW			RO	
41559	1558	VRMS AVG MIN [V] MSW	L1-L2	Minimum VRMS calculated over the configured average time [V]	RW	FLOAT32
41560	1559	VRMS AVG MIN [V] LSW			RW	
41561	1560	VRMS AVG MAX [V] MSW	L1-L2	Maximum VRMS calculated over the configured average time [V]	RW	FLOAT32
41562	1561	VRMS AVG MAX [V] LSW			RW	
41563	1562	VRMS MIN [V] MSW	L1-L2		RW	FLOAT32

ADDRESS (4x)	ADDRESS OFFSET	REGISTER	PHASE	DESCRIPTION	W/R	TYPE
41564	1563	VRMS MIN [V] LSW		Minimum VRMS since device power up [V]	RW	
41565	1564	VRMS MAX [V] MSW	L1-L2	Maximum VRMS since device power up [V]	RW	FLOAT32
41566	1565	VRMS MAX [V] LSW			RW	
41567	1566	VRMS AVG [V] MSW	L2-L3	Average VRMS calculated over the configured average time [V]	RO	FLOAT32
41568	1567	VRMS AVG [V] LSW			RO	
41569	1568	VRMS AVG MIN [V] MSW	L2-L3	Minimum VRMS calculated over the configured average time [V]	RW	FLOAT32
41570	1569	VRMS AVG MIN [V] LSW			RW	
41571	1570	VRMS AVG MAX [V] MSW	L2-L3	Maximum VRMS calculated over the configured average time [V]	RW	FLOAT32
41572	1571	VRMS AVG MAX [V] LSW			RW	
41573	1572	VRMS MIN [V] MSW	L2-L3	Minimum VRMS since device power up [V]	RW	FLOAT32
41574	1573	VRMS MIN [V] LSW			RW	
41575	1574	VRMS MAX [V] MSW	L2-L3	Maximum VRMS since device power up [V]	RW	FLOAT32
41576	1575	VRMS MAX [V] LSW			RW	
41577	1576	VRMS AVG [V] MSW	L3-L1	Average VRMS calculated over the configured average time [V]	RO	FLOAT32
41578	1577	VRMS AVG [V] LSW			RO	
41579	1578	VRMS AVG MIN [V] MSW	L3-L1	Minimum VRMS calculated over the configured average time [V]	RW	FLOAT32
41580	1579	VRMS AVG MIN [V] LSW			RW	
41581	1580	VRMS AVG MAX [V] MSW	L3-L1	Maximum VRMS calculated over the configured average time [V]	RW	FLOAT32
41582	1581	VRMS AVG MAX [V] LSW			RW	
41583	1582	VRMS MIN [V] MSW	L3-L1	Minimum VRMS since device power up [V]	RW	FLOAT32
41584	1583	VRMS MIN [V] LSW			RW	
41585	1584	VRMS MAX [V] MSW	L3-L1	Maximum VRMS since device power up [V]	RW	FLOAT32
41586	1585	VRMS MAX [V] LSW			RW	
41587	1586	P AVG [W] MSW	L1	Average Active Power calculated over the configured average time [W]	RO	FLOAT32
41588	1587	P AVG [W] LSW			RO	
41589	1588	P AVG MIN [W] MSW	L1	Minimum Active Power calculated over the configured average time [W]	RW	FLOAT32
41590	1589	P AVG MIN [W] LSW			RW	
41591	1590	P AVG MAX [W] MSW	L1	Maximum Active Power calculated over the configured average time [W]	RW	FLOAT32
41592	1591	P AVG MAX [W] LSW			RW	

ADDRESS (4x)	ADDRESS OFFSET	REGISTER	PHASE	DESCRIPTION	W/R	TYPE
41593	1592	P MIN [W] MSW	L1	Minimum Active Power since device power up [W]	RW	FLOAT32
41594	1593	P MIN [W] LSW			RW	
41595	1594	P MAX [W] MSW	L1	Maximum Active Power since device power up [W]	RW	FLOAT32
41596	1595	P MAX [W] LSW			RW	
41597	1596	P AVG [W] MSW	L2	Average Active Power calculated over the configured average time [W]	RO	FLOAT32
41598	1597	P AVG [W] LSW			RO	
41599	1598	P AVG MIN [W] MSW	L2	Minimum Active Power calculated over the configured average time [W]	RW	FLOAT32
41600	1599	P AVG MIN [W] LSW			RW	
41601	1600	P AVG MAX [W] MSW	L2	Maximum Active Power calculated over the configured average time [WA]	RW	FLOAT32
41602	1601	P AVG MAX [W] LSW			RW	
41603	1602	P MIN [W] MSW	L2	Minimum Active Power since device power up [W]	RW	FLOAT32
41604	1603	P MIN [W] LSW			RW	
41605	1604	P MAX [W] MSW	L2	Maximum Active Power since device power up [W]	RW	FLOAT32
41606	1605	P MAX [W] LSW			RW	
41607	1606	P AVG [W] MSW	L3	Average Active Power calculated over the configured average time [W]	RO	FLOAT32
41608	1607	P AVG [W] LSW			RO	
41609	1608	P AVG MIN [W] MSW	L3	Minimum Active Power calculated over the configured average time [W]	RW	FLOAT32
41610	1609	P AVG MIN [W] LSW			RW	
41611	1610	P AVG MAX [W] MSW	L3	Maximum Active Power calculated over the configured average time [WA]	RW	FLOAT32
41612	1611	P AVG MAX [W] LSW			RW	
41613	1612	P MIN [W] MSW	L3	Minimum Active Power since device power up [W]	RW	FLOAT32
41614	1613	P MIN [W] LSW			RW	
41615	1614	P MAX [W] MSW	L3	Maximum Active Power since device power up [W]	RW	FLOAT32
41616	1615	P MAX [W] LSW			RW	
41617	1616	Q AVG [VAR] MSW	L1	Average Reactive Power calculated over the configured average time [VAR]	RO	FLOAT32
41618	1617	Q AVG [VAR] LSW			RO	
41619	1618	Q AVG MIN [VAR] MSW	L1	Minimum Reactive Power calculated over the configured average time [VAR]	RW	FLOAT32
41620	1619	Q AVG MIN [VAR] LSW			RW	

ADDRESS (4x)	ADDRESS OFFSET	REGISTER	PHASE	DESCRIPTION	W/R	TYPE
41621	1620	Q AVG MAX [VAR] MSW	L1	Maximum Reactive Power calculated over the configured average time [VAR]	RW	FLOAT32
41622	1621	Q AVG MAX [VAR] LSW			RW	
41623	1622	Q MIN [VAR] MSW	L1	Minimum Reactive Power since device power up [VAR]	RW	FLOAT32
41624	1623	Q MIN [VAR] LSW			RW	
41625	1624	Q MAX [VAR] MSW	L1	Maximum Reactive Power since device power up [VAR]	RW	FLOAT32
41626	1625	Q MAX [VAR] LSW			RW	
41627	1626	Q AVG [VAR] MSW	L2	Average Reactive Power calculated over the configured average time [VAR]	RO	FLOAT32
41628	1627	Q AVG [VAR] LSW			RO	
41629	1628	Q AVG MIN [VAR] MSW	L2	Minimum Reactive Power calculated over the configured average time [VAR]	RW	FLOAT32
41630	1629	Q AVG MIN [VAR] LSW			RW	
41631	1630	Q AVG MAX [VAR] MSW	L2	Maximum Reactive Power calculated over the configured average time [VAR]	RW	FLOAT32
41632	1631	Q AVG MAX [VAR] LSW			RW	
41633	1632	Q MIN [VAR] MSW	L2	Minimum Reactive Power since device power up [VAR]	RW	FLOAT32
41634	1633	Q MIN [VAR] LSW			RW	
41635	1634	Q MAX [VAR] MSW	L2	Maximum Reactive Power since device power up [VAR]	RW	FLOAT32
41636	1635	Q MAX [VAR] LSW			RW	
41637	1636	Q AVG [VAR] MSW	L3	Average Reactive Power calculated over the configured average time [VAR]	RO	FLOAT32
41638	1637	Q AVG [VAR] LSW			RO	
41639	1638	Q AVG MIN [VAR] MSW	L3	Minimum Reactive Power calculated over the configured average time [VAR]	RW	FLOAT32
41640	1639	Q AVG MIN [VAR] LSW			RW	
41641	1640	Q AVG MAX [VAR] MSW	L3	Maximum Reactive Power calculated over the configured average time [VAR]	RW	FLOAT32
41642	1641	Q AVG MAX [VAR] LSW			RW	
41643	1642	Q MIN [VAR] MSW	L3	Minimum Reactive Power since device power up [VAR]	RW	FLOAT32
41644	1643	Q MIN [VAR] LSW			RW	
41645	1644	Q MAX [VAR] MSW	L3	Maximum Reactive Power since device power up [VAR]	RW	FLOAT32
41646	1645	Q MAX [VAR] LSW			RW	
41647	1646	S AVG [VA] MSW	L1	Average Apparent Power calculated over the configured average time [VA]	RO	FLOAT32
41648	1647	S AVG [VA] LSW			RO	

ADDRESS (4x)	ADDRESS OFFSET	REGISTER	PHASE	DESCRIPTION	W/R	TYPE
41649	1648	S AVG MIN [VA] MSW	L1	Minimum Apparent Power calculated over the configured average time [VA]	RW	FLOAT32
41650	1649	S AVG MIN [VA] LSW			RW	
41651	1650	S AVG MAX [VA] MSW	L1	Maximum Apparent Power calculated over the configured average time [VA]	RW	FLOAT32
41652	1651	S AVG MAX [VA] LSW			RW	
41653	1652	S MIN [VA] MSW	L1	Minimum Apparent Power since device power up [VA]	RW	FLOAT32
41654	1653	S MIN [VA] LSW			RW	
41655	1654	S MAX [VA] MSW	L1	Maximum Apparent Power since device power up [VA]	RW	FLOAT32
41656	1655	S MAX [VA] LSW			RW	
41657	1656	S AVG [VA] MSW	L2	Average Apparent Power calculated over the configured average time [VA]	RO	FLOAT32
41658	1657	S AVG [VA] LSW			RO	
41659	1658	S AVG MIN [VA] MSW	L2	Minimum Apparent Power calculated over the configured average time [VA]	RW	FLOAT32
41660	1659	S AVG MIN [VA] LSW			RW	
41661	1660	S AVG MAX [VA] MSW	L2	Maximum Apparent Power calculated over the configured average time [VA]	RW	FLOAT32
41662	1661	S AVG MAX [VA] LSW			RW	
41663	1662	S MIN [VA] MSW	L2	Minimum Apparent Power since device power up [VA]	RW	FLOAT32
41664	1663	S MIN [VA] LSW			RW	
41665	1664	S MAX [VA] MSW	L2	Maximum Apparent Power since device power up [VA]	RW	FLOAT32
41666	1665	S MAX [VA] LSW			RW	
41667	1666	S AVG [VA] MSW	L3	Average Apparent Power calculated over the configured average time [VA]	RO	FLOAT32
41668	1667	S AVG [VA] LSW			RO	
41669	1668	S AVG MIN [VA] MSW	L3	Minimum Apparent Power calculated over the configured average time [VA]	RW	FLOAT32
41670	1669	S AVG MIN [VA] LSW			RW	
41671	1670	S AVG MAX [VA] MSW	L3	Maximum Apparent Power calculated over the configured average time [VA]	RW	FLOAT32
41672	1671	S AVG MAX [VA] LSW			RW	
41673	1672	S MIN [VA] MSW	L3	Minimum Apparent Power since device power up [VA]	RW	FLOAT32
41674	1673	S MIN [VA] LSW			RW	
41675	1674	S MAX [VA] MSW	L3	Maximum Apparent Power since device power up [VA]	RW	FLOAT32
41676	1675	S MAX [VA] LSW			RW	

ADDRESS (4x)	ADDRESS OFFSET	REGISTER	PHASE	DESCRIPTION	W/R	TYPE
41677	1676	PF AVG MSW	L1	Average Power Factor calculated over the configured average time	RO	FLOAT32
41678	1677	PF AVG LSW			RO	
41679	1678	PF AVG MIN MSW	L1	Minimum Power Factor calculated over the configured average time	RW	FLOAT32
41680	1679	PF AVG MIN LSW			RW	
41681	1680	PF AVG MAX MSW	L1	Maximum Power Factor calculated over the configured average time	RW	FLOAT32
41682	1681	PF AVG MAX LSW			RW	
41683	1682	PF MIN MSW	L1	Minimum Power Factor since device power up	RW	FLOAT32
41684	1683	PF MIN LSW			RW	
41685	1684	PF MAX MSW	L1	Maximum Power Factor since device power up	RW	FLOAT32
41686	1685	PF MAX LSW			RW	
41687	1686	PF AVG MSW	L2	Average Power Factor calculated over the configured average time	RO	FLOAT32
41688	1687	PF AVG LSW			RO	
41689	1688	PF AVG MIN MSW	L2	Minimum Power Factor calculated over the configured average time	RW	FLOAT32
41690	1689	PF AVG MIN LSW			RW	
41691	1690	PF AVG MAX MSW	L2	Maximum Power Factor calculated over the configured average time	RW	FLOAT32
41692	1691	PF AVG MAX LSW			RW	
41693	1692	PF MIN MSW	L2	Minimum Power Factor since device power up	RW	FLOAT32
41694	1693	PF MIN LSW			RW	
41695	1694	PF MAX MSW	L2	Maximum Power Factor since device power up	RW	FLOAT32
41696	1695	PF MAX LSW			RW	
41697	1696	PF AVG MSW	L3	Average Power Factor calculated over the configured average time	RO	FLOAT32
41698	1697	PF AVG LSW			RO	
41699	1698	PF AVG MIN MSW	L3	Minimum Power Factor calculated over the configured average time	RW	FLOAT32
41700	1699	PF AVG MIN LSW			RW	
41701	1700	PF AVG MAX MSW	L3	Maximum Power Factor calculated over the configured average time	RW	FLOAT32
41702	1701	PF AVG MAX LSW			RW	
41703	1702	PF MIN MSW	L3		RW	FLOAT32

ADDRESS (4x)	ADDRESS OFFSET	REGISTER	PHASE	DESCRIPTION	W/R	TYPE
41704	1703	PF MIN LSW		Minimum Power Factor since device power up	RW	
41705	1704	PF MAX MSW	L3	Maximum Power Factor since device power up	RW	FLOAT32
41706	1705	PF MAX LSW			RW	
41707	1706	P AVG [W] MSW	3PH	Average Active Power calculated over the configured average time [W]	RO	FLOAT32
41708	1707	P AVG [W] LSW			RO	
41709	1708	P AVG MIN [W] MSW	3PH	Minimum Active Power calculated over the configured average time [W]	RW	FLOAT32
41710	1709	P AVG MIN [W] LSW			RW	
41711	1710	P AVG MAX [W] MSW	3PH	Maximum Active Power calculated over the configured average time [WA]	RW	FLOAT32
41712	1711	P AVG MAX [W] LSW			RW	
41713	1712	P MIN [W] MSW	3PH	Minimum Active Power since device power up [W]	RW	FLOAT32
41714	1713	P MIN [W] LSW			RW	
41715	1714	P MAX [W] MSW	3PH	Maximum Active Power since device power up [W]	RW	FLOAT32
41716	1715	P MAX [W] LSW			RW	
41717	1716	Q AVG [VAR] MSW	3PH	Average Reactive Power calculated over the configured average time [VAR]	RO	FLOAT32
41718	1717	Q AVG [VAR] LSW			RO	
41719	1718	Q AVG MIN [VAR] MSW	3PH	Minimum Reactive Power calculated over the configured average time [VAR]	RW	FLOAT32
41720	1719	Q AVG MIN [VAR] LSW			RW	
41721	1720	Q AVG MAX [VAR] MSW	3PH	Maximum Reactive Power calculated over the configured average time [VAR]	RW	FLOAT32
41722	1721	Q AVG MAX [VAR] LSW			RW	
41723	1722	Q MIN [VAR] MSW	3PH	Minimum Reactive Power since device power up [VAR]	RW	FLOAT32
41724	1723	Q MIN [VAR] LSW			RW	
41725	1724	Q MAX [VAR] MSW	3PH	Maximum Reactive Power since device power up [VAR]	RW	FLOAT32
41726	1725	Q MAX [VAR] LSW			RW	
41727	1726	S AVG [VA] MSW	3PH	Average Apparent Power calculated over the configured average time [VA]	RO	FLOAT32
41728	1727	S AVG [VA] LSW			RO	
41729	1728	S AVG MIN [VA] MSW	3PH	Minimum Apparent Power calculated over the configured average time [VA]	RW	FLOAT32
41730	1729	S AVG MIN [VA] LSW			RW	



ADDRESS (4x)	ADDRESS OFFSET	REGISTER	PHASE	DESCRIPTION	W/R	TYPE
41731	1730	S AVG MAX [VA] MSW	3PH	Maximum Apparent Power calculated over the configured average time [VA]	RW	FLOAT32
41732	1731	S AVG MAX [VA] LSW			RW	
41733	1732	S MIN [VA] MSW	3PH	Minimum Apparent Power since device power up [VA]	RW	FLOAT32
41734	1733	S MIN [VA] LSW			RW	
41735	1734	S MAX [VA] MSW	3PH	Maximum Apparent Power since device power up [VA]	RW	FLOAT32
41736	1735	S MAX [VA] LSW			RW	
41737	1736	PF AVG MSW	3PH	Average Power Factor calculated over the configured average time	RO	FLOAT32
41738	1737	PF AVG LSW			RO	
41739	1738	PF AVG MIN MSW	3PH	Minimum Power Factor calculated over the configured average time	RW	FLOAT32
41740	1739	PF AVG MIN LSW			RW	
41741	1740	PF AVG MAX MSW	3PH	Maximum Power Factor calculated over the configured average time	RW	FLOAT32
41742	1741	PF AVG MAX LSW			RW	
41743	1742	PF MIN MSW	3PH	Minimum Power Factor since device power up	RW	FLOAT32
41744	1743	PF MIN LSW			RW	
41745	1744	PF MAX MSW	3PH	Maximum Power Factor since device power up	RW	FLOAT32
41746	1745	PF MAX LSW			RW	
41747	1746	E ACTIVE ENERGY (+) [Wh] MMSW	L1	Active Energy (Only +) Q1-Q4 [Wh]	RW	UNSIGNED64
41748	1747	E ACTIVE ENERGY (+) [Wh] MSW			RW	
41749	1748	E ACTIVE ENERGY (+) [Wh] LSW			RW	
41750	1749	E ACTIVE ENERGY (+) [Wh] LLSW			RW	
41751	1750	E ACTIVE ENERGY (+) [Wh] MMSW	L2	Active Energy (Only +) Q1-Q4 [Wh]	RW	UNSIGNED64
41752	1751	E ACTIVE ENERGY (+) [Wh] MSW			RW	
41753	1752	E ACTIVE ENERGY (+) [Wh] LSW			RW	
41754	1753	E ACTIVE ENERGY (+) [Wh] LLSW			RW	
41755	1754	E ACTIVE ENERGY (+) [Wh] MMSW	L3	Active Energy (Only +) Q1-Q4 [Wh]	RW	UNSIGNED64
41756	1755	E ACTIVE ENERGY (+) [Wh] MSW			RW	
41757	1756	E ACTIVE ENERGY (+) [Wh] LSW			RW	
41758	1757	E ACTIVE ENERGY (+) [Wh] LLSW			RW	

ADDRESS (4x)	ADDRESS OFFSET	REGISTER	PHASE	DESCRIPTION	W/R	TYPE
41759	1758	E ACTIVE ENERGY (-) [Wh] MMSW	L1	Active Energy (Only -) Q2-Q3 [Wh]	RW	UNSIGNED64
41760	1759	E ACTIVE ENERGY (-) [Wh] MSW			RW	
41761	1760	E ACTIVE ENERGY (-) [Wh] LSW			RW	
41762	1761	E ACTIVE ENERGY (-) [Wh] LLSW			RW	
41763	1762	E ACTIVE ENERGY (-) [Wh] MMSW	L2	Active Energy (Only -) Q2-Q3 [Wh]	RW	UNSIGNED64
41764	1763	E ACTIVE ENERGY (-) [Wh] MSW			RW	
41765	1764	E ACTIVE ENERGY (-) [Wh] LSW			RW	
41766	1765	E ACTIVE ENERGY (-) [Wh] LLSW			RW	
41767	1766	E ACTIVE ENERGY (-) [Wh] MMSW	L3	Active Energy (Only -) Q2-Q3 [Wh]	RW	UNSIGNED64
41768	1767	E ACTIVE ENERGY (-) [Wh] MSW			RW	
41769	1768	E ACTIVE ENERGY (-) [Wh] LSW			RW	
41770	1769	E ACTIVE ENERGY (-) [Wh] LLSW			RW	
41771	1770	E REACTIVE ENERGY (+) [VARh] MMSW	L1	Reactive Energy (Only +) Q1-Q2 [VARh]	RW	UNSIGNED64
41772	1771	E REACTIVE ENERGY (+) [VARh] MSW			RW	
41773	1772	E REACTIVE ENERGY (+) [VARh] LSW			RW	
41774	1773	E REACTIVE ENERGY (+) [VARh] LLSW			RW	
41775	1774	E REACTIVE ENERGY (+) [VARh] MMSW	L2	Reactive Energy (Only +) Q1-Q2 [VARh]	RW	UNSIGNED64
41776	1775	E REACTIVE ENERGY (+) [VARh] MSW			RW	
41777	1776	E REACTIVE ENERGY (+) [VARh] LSW			RW	
41778	1777	E REACTIVE ENERGY (+) [VARh] LLSW			RW	
41779	1778	E REACTIVE ENERGY (+) [VARh] MMSW	L3	Reactive Energy (Only +) Q1-Q2 [VARh]	RW	UNSIGNED64
41780	1779	E REACTIVE ENERGY (+) [VARh] MSW			RW	
41781	1780	E REACTIVE ENERGY (+) [VARh] LSW			RW	
41782	1781	E REACTIVE ENERGY (+) [VARh] LLSW			RW	
41783	1782	E REACTIVE ENERGY (-) [VARh] MMSW	L1	Reactive Energy (Only -) Q3-Q4 [VARh]	RW	UNSIGNED64
41784	1783	E REACTIVE ENERGY (-) [VARh] MSW			RW	
41785	1784	E REACTIVE ENERGY (-) [VARh] LSW			RW	
41786	1785	E REACTIVE ENERGY (-) [VARh] LLSW			RW	

ADDRESS (4x)	ADDRESS OFFSET	REGISTER	PHASE	DESCRIPTION	W/R	TYPE
41787	1786	E REACTIVE ENERGY (-) [VARh] MMSW	L2	Reactive Energy (Only -) Q3-Q4 [VARh]	RW	UNSIGNED64
41788	1787	E REACTIVE ENERGY (-) [VARh] MSW			RW	
41789	1788	E REACTIVE ENERGY (-) [VARh] LSW			RW	
41790	1789	E REACTIVE ENERGY (-) [VARh] LLSW			RW	
41791	1790	E REACTIVE ENERGY (-) [VARh] MMSW	L3	Reactive Energy (Only -) Q3-Q4 [VARh]	RW	UNSIGNED64
41792	1791	E REACTIVE ENERGY (-) [VARh] MSW			RW	
41793	1792	E REACTIVE ENERGY (-) [VARh] LSW			RW	
41794	1793	E REACTIVE ENERGY (-) [VARh] LLSW			RW	
41795	1794	E REACTIVE ENERGY (+)[VARh] MMSW	L1	Reactive Energy (Only +) Q1 [VARh]	RW	UNSIGNED64
41796	1795	E REACTIVE ENERGY (+)[VARh] MSW			RW	
41797	1796	E REACTIVE ENERGY (+)[VARh] LSW			RW	
41798	1797	E REACTIVE ENERGY (+)[VARh] LLSW			RW	
41799	1798	E REACTIVE ENERGY (+)[VARh] MMSW	L2	Reactive Energy (Only +) Q1 [VARh]	RW	UNSIGNED64
41800	1799	E REACTIVE ENERGY (+)[VARh] MSW			RW	
41801	1800	E REACTIVE ENERGY (+)[VARh] LSW			RW	
41802	1801	E REACTIVE ENERGY (+)[VARh] LLSW			RW	
41803	1802	E REACTIVE ENERGY (+)[VARh] MMSW	L3	Reactive Energy (Only +) Q1 [VARh]	RW	UNSIGNED64
41804	1803	E REACTIVE ENERGY (+)[VARh] MSW			RW	
41805	1804	E REACTIVE ENERGY (+)[VARh] LSW			RW	
41806	1805	E REACTIVE ENERGY (+)[VARh] LLSW			RW	
41807	1806	E REACTIVE ENERGY (-) [VARh] MMSW	L1	Reactive Energy (Only -) Q2 [VARh]	RW	UNSIGNED64
41808	1807	E REACTIVE ENERGY (-) [VARh] MSW			RW	

ADDRESS (4x)	ADDRESS OFFSET	REGISTER	PHASE	DESCRIPTION	W/R	TYPE
41809	1808	E REACTIVE ENERGY (-) [VARh] LSW			RW	
41810	1809	E REACTIVE ENERGY (-) [VARh] LLSW			RW	
41811	1810	E REACTIVE ENERGY (-) [VARh] MMSW	L2	Reactive Energy (Only -) Q2 [VARh]	RW	UNSIGNED64
41812	1811	E REACTIVE ENERGY (-) [VARh] MSW			RW	
41813	1812	E REACTIVE ENERGY (-) [VARh] LSW			RW	
41814	1813	E REACTIVE ENERGY (-) [VARh] LLSW			RW	
41815	1814	E REACTIVE ENERGY (-) [VARh] MMSW	L3	Reactive Energy (Only -) Q2 [VARh]	RW	UNSIGNED64
41816	1815	E REACTIVE ENERGY (-) [VARh] MSW			RW	
41817	1816	E REACTIVE ENERGY (-) [VARh] LSW			RW	
41818	1817	E REACTIVE ENERGY (-) [VARh] LLSW			RW	
41819	1818	E REACTIVE ENERGY (-)[VARh] MMSW	L1	Reactive Energy (Only -) Q4 [VARh]	RW	UNSIGNED64
41820	1819	E REACTIVE ENERGY (-) [VARh] MSW			RW	
41821	1820	E REACTIVE ENERGY (-) [VARh] LSW			RW	
41822	1821	E REACTIVE ENERGY (-) [VARh] LLSW			RW	
41823	1822	E REACTIVE ENERGY (-)[VARh] MMSW	L2	Reactive Energy (Only -) Q4 [VARh]	RW	UNSIGNED64
41824	1823	E REACTIVE ENERGY (-) [VARh] MSW			RW	
41825	1824	E REACTIVE ENERGY (-) [VARh] LSW			RW	
41826	1825	E REACTIVE ENERGY (-) [VARh] LLSW			RW	
41827	1826	E REACTIVE ENERGY (-)[VARh] MMSW	L3	Reactive Energy (Only -) Q4 [VARh]	RW	UNSIGNED64
41828	1827	E REACTIVE ENERGY (-) [VARh] MSW			RW	

ADDRESS (4x)	ADDRESS OFFSET	REGISTER	PHASE	DESCRIPTION	W/R	TYPE
41829	1828	E REACTIVE ENERGY (-) [VARh] LSW			RW	
41830	1829	E REACTIVE ENERGY (-) [VARh] LLSW			RW	
41831	1830	E REACTIVE ENERGY (-)[VARh] MMSW	L1	Reactive Energy (Only -) Q3 [VARh]	RW	UNSIGNED64
41832	1831	E REACTIVE ENERGY (-)[VARh] MSW			RW	
41833	1832	E REACTIVE ENERGY (-)[VARh] LSW			RW	
41834	1833	E REACTIVE ENERGY (-)[VARh] LLSW			RW	
41835	1834	E REACTIVE ENERGY (-)[VARh] MMSW	L2	Reactive Energy (Only -) Q3 [VARh]	RW	UNSIGNED64
41836	1835	E REACTIVE ENERGY (-) [VARh] MSW			RW	
41837	1836	E REACTIVE ENERGY (-) [VARh] LSW			RW	
41838	1837	E REACTIVE ENERGY (-) [VARh] LLSW			RW	
41839	1838	E REACTIVE ENERGY (-) [VARh] MMSW	L3	Reactive Energy (Only -) Q3 [VARh]	RW	UNSIGNED64
41840	1839	E REACTIVE ENERGY (-) [VARh] MSW			RW	
41841	1840	E REACTIVE ENERGY (-) [VARh] LSW			RW	
41842	1841	E REACTIVE ENERGY (-) [VARh] LLSW			RW	
41843	1842	E ACTIVE ENERGY [Wh] MMSW	L1	Total Active Energy [Wh]	RW	UNSIGNED64
41844	1843	E ACTIVE ENERGY [Wh] MSW			RW	
41845	1844	E ACTIVE ENERGY [Wh] LSW			RW	
41846	1845	E ACTIVE ENERGY [Wh] LLSW			RW	
41847	1846	E ACTIVE ENERGY [Wh] MMSW	L2	Total Active Energy [Wh]	RW	SIGNED64
41848	1847	E ACTIVE ENERGY [Wh] MSW			RW	
41849	1848	E ACTIVE ENERGY [Wh] LSW			RW	
41850	1849	E ACTIVE ENERGY [Wh] LLSW			RW	
41851	1850	E ACTIVE ENERGY [Wh] MMSW	L3	Total Active Energy [Wh]	RW	SIGNED64
41852	1851	E ACTIVE ENERGY [Wh] MSW			RW	
41853	1852	E ACTIVE ENERGY [Wh] LSW			RW	
41854	1853	E ACTIVE ENERGY [Wh] LLSW			RW	

ADDRESS (4x)	ADDRESS OFFSET	REGISTER	PHASE	DESCRIPTION	W/R	TYPE
41855	1854	E REACTIVE ENERGY [VARh] MMSW	L1	Total Reactive Energy [VARh]	RW	SIGNED64
41856	1855	E REACTIVE ENERGY [VARh] MSW			RW	
41857	1856	E REACTIVE ENERGY [VARh] LSW			RW	
41858	1857	E REACTIVE ENERGY [VARh] LLSW			RW	
41859	1858	E REACTIVE ENERGY [VARh] MMSW	L2	Total Reactive Energy [VARh]	RW	SIGNED64
41860	1859	E REACTIVE ENERGY [VARh] MSW			RW	
41861	1860	E REACTIVE ENERGY [VARh] LSW			RW	
41862	1861	E REACTIVE ENERGY [VARh] LLSW			RW	
41863	1862	E REACTIVE ENERGY [VARh] MMSW	L3	Total Reactive Energy [VARh]	RW	SIGNED64
41864	1863	E REACTIVE ENERGY [VARh] MSW			RW	
41865	1864	E REACTIVE ENERGY [VARh] LSW			RW	
41866	1865	E REACTIVE ENERGY [VARh] LLSW			RW	
41867	1866	E REACTIVE ENERGY [VARh] MMSW	L1	Total Apparent Energy [VAh]	RW	SIGNED64
41868	1867	E REACTIVE ENERGY [VARh] MSW			RW	
41869	1868	E REACTIVE ENERGY [VARh] LSW			RW	
41870	1869	E REACTIVE ENERGY [VARh] LLSW			RW	
41871	1870	E REACTIVE ENERGY [VARh] MMSW	L2	Total Apparent Energy [VAh]	RW	SIGNED64
41872	1871	E REACTIVE ENERGY [VARh] MSW			RW	
41873	1872	E REACTIVE ENERGY [VARh] LSW			RW	
41874	1873	E REACTIVE ENERGY [VARh] LLSW			RW	
41875	1874	E REACTIVE ENERGY [VARh] MMSW	L3	Total Apparent Energy [VAh]	RW	SIGNED64
41876	1875	E REACTIVE ENERGY [VARh] MSW			RW	
41877	1876	E REACTIVE ENERGY [VARh] LSW			RW	
41878	1877	E REACTIVE ENERGY [VARh] LLSW			RW	
41879	1878	E ACTIVE ENERGY (+) [Wh] MMSW	3PH	Active Energy (Only +) Q1-Q4 [Wh]	RW	UNSIGNED64

ADDRESS (4x)	ADDRESS OFFSET	REGISTER	PHASE	DESCRIPTION	W/R	TYPE
41880	1879	E ACTIVE ENERGY (+) [Wh] MSW			RW	
41881	1880	E ACTIVE ENERGY (+) [Wh] LSW			RW	
41882	1881	E ACTIVE ENERGY (+) [Wh] LLSW			RW	
41883	1882	E ACTIVE ENERGY (-) [Wh] MMSW	3PH	Active Energy (Only -) Q2-Q3 [Wh]	RW	UNSIGNED64
41884	1883	E ACTIVE ENERGY (-) [Wh] MSW			RW	
41885	1884	E ACTIVE ENERGY (-) [Wh] LSW			RW	
41886	1885	E ACTIVE ENERGY (-) [Wh] LLSW			RW	
41887	1886	E REACTIVE ENERGY (+) [VARh] MMSW	3PH	Reactive Energy (Only +) Q1-Q2 [Wh]	RW	UNSIGNED64
41888	1887	E REACTIVE ENERGY (+) [VARh] MSW			RW	
41889	1888	E REACTIVE ENERGY (+) [VARh] LSW			RW	
41890	1889	E REACTIVE ENERGY (+) [VARh] LLSW			RW	
41891	1890	E REACTIVE ENERGY (-) [VARh] MMSW	3PH	Reactive Energy (Only -) Q3-Q4 [Wh]	RW	UNSIGNED64
41892	1891	E REACTIVE ENERGY (-) [VARh] MSW			RW	
41893	1892	E REACTIVE ENERGY (-) [VARh] LSW			RW	
41894	1893	E REACTIVE ENERGY (-) [VARh] LLSW			RW	
41895	1894	E ACTIVE ENERGY [Wh] MMSW	3PH	Total Active Energy [Wh]	RW	SIGNED64
41896	1895	E ACTIVE ENERGY [Wh] MSW			RW	
41897	1896	E ACTIVE ENERGY [Wh] LSW			RW	
41898	1897	E ACTIVE ENERGY [Wh] LLSW			RW	
41899	1898	E REACTIVE ENERGY [VARh] MMSW	3PH	Total Reactive Energy [Varh]	RW	SIGNED64
41900	1899	E REACTIVE ENERGY [VARh] MSW			RW	
41901	1900	E REACTIVE ENERGY [VARh] LSW			RW	
41902	1901	E REACTIVE ENERGY [VARh] LLSW			RW	
41903	1902	E APPARENT ENERGY [VAh] MMSW	3PH	Total Apparent Energy [VAh]	RW	SIGNED64
41904	1903	E APPARENT ENERGY [VAh] MSW			RW	
41905	1904	E APPARENT ENERGY [VAh] LSW			RW	
41906	1905	E APPARENT ENERGY [VAh] LLSW			RW	
41923	1922	THD I AVG MSW	L1	Average Current THD calculated over the	RO	FLOAT32
41924	1923	THD I AVG LSW			RO	

ADDRESS (4x)	ADDRESS OFFSET	REGISTER	PHASE	DESCRIPTION	W/R	TYPE
				configured average time		
<b>41925</b>	1924	THD I AVG MIN MSW	L1	Minimum Current THD calculated over the configured average time	RW	FLOAT32
<b>41926</b>	1925	THD I AVG MIN LSW			RW	
<b>41927</b>	1926	THD I AVG MAX MSW	L1	Maximum Current THD calculated over the configured average time	RW	FLOAT32
<b>41928</b>	1927	THD I AVG MAX LSW			RW	
<b>41929</b>	1928	THD I MIN MSW	L1	Minimum Current THD since device power up	RW	FLOAT32
<b>41930</b>	1929	THD I MIN LSW			RW	
<b>41931</b>	1930	THD I MAX MSW	L1	Maximum Current THD since device power up	RW	FLOAT32
<b>41932</b>	1931	THD I MAX LSW			RW	
<b>41933</b>	1932	THD I AVG MSW	L2	Average Current THD calculated over the configured average time	RO	FLOAT32
<b>41934</b>	1933	THD I AVG LSW			RO	
<b>41935</b>	1934	THD I AVG MIN MSW	L2	Minimum Current THD calculated over the configured average time	RW	FLOAT32
<b>41936</b>	1935	THD I AVG MIN LSW			RW	
<b>41937</b>	1936	THD I AVG MAX MSW	L2	Maximum Current THD calculated over the configured average time	RW	FLOAT32
<b>41938</b>	1937	THD I AVG MAX LSW			RW	
<b>41939</b>	1938	THD I MIN MSW	L2	Minimum Current THD since device power up	RW	FLOAT32
<b>41940</b>	1939	THD I MIN LSW			RW	
<b>41941</b>	1940	THD I MAX MSW	L2	Maximum Current THD since device power up	RW	FLOAT32
<b>41942</b>	1941	THD I MAX LSW			RW	
<b>41943</b>	1942	THD I AVG MSW	L3	Average Current THD calculated over the configured average time	RO	FLOAT32
<b>41944</b>	1943	THD I AVG LSW			RO	
<b>41945</b>	1944	THD I AVG MIN MSW	L3	Minimum Current THD calculated over the configured average time	RW	FLOAT32
<b>41946</b>	1945	THD I AVG MIN LSW			RW	
<b>41947</b>	1946	THD I AVG MAX MSW	L3	Maximum Current THD calculated over the configured average time	RW	FLOAT32
<b>41948</b>	1947	THD I AVG MAX LSW			RW	
<b>41949</b>	1948	THD I MIN MSW	L3	Minimum Current THD since device power up	RW	FLOAT32
<b>41950</b>	1949	THD I MIN LSW			RW	
<b>41951</b>	1950	THD I MAX MSW	L3	Maximum Current THD since device power up	RW	FLOAT32
<b>41952</b>	1951	THD I MAX LSW			RW	



ADDRESS (4x)	ADDRESS OFFSET	REGISTER	PHASE	DESCRIPTION	W/R	TYPE
41953	1952	THD I AVG MSW	L1	Average Voltage THD calculated over the configured average time	RO	FLOAT32
41954	1953	THD V AVG LSW			RO	
41955	1954	THD V AVG MIN MSW	L1	Minimum Voltage THD calculated over the configured average time	RW	FLOAT32
41956	1955	THD V AVG MIN LSW			RW	
41957	1956	THD V AVG MAX MSW	L1	Maximum Voltage THD calculated over the configured average time	RW	FLOAT32
41958	1957	THD V AVG MAX LSW			RW	
41959	1958	THD V MIN MSW	L1	Minimum Voltage THD since device power up	RW	FLOAT32
41960	1959	THD V MIN LSW			RW	
41961	1960	THD V MAX MSW	L1	Maximum Voltage THD since device power up	RW	FLOAT32
41962	1961	THD V MAX LSW			RW	
41963	1962	THD I AVG MSW	L2	Average Voltage THD calculated over the configured average time	RO	FLOAT32
41964	1963	THD V AVG LSW			RO	
41965	1964	THD V AVG MIN MSW	L2	Minimum Voltage THD calculated over the configured average time	RW	FLOAT32
41966	1965	THD V AVG MIN LSW			RW	
41967	1966	THD V AVG MAX MSW	L2	Maximum Voltage THD calculated over the configured average time	RW	FLOAT32
41968	1967	THD V AVG MAX LSW			RW	
41969	1968	THD V MIN MSW	L2	Minimum Voltage THD since device power up	RW	FLOAT32
41970	1969	THD V MIN LSW			RW	
41971	1970	THD V MAX MSW	L2	Maximum Voltage THD since device power up	RW	FLOAT32
41972	1971	THD V MAX LSW			RW	
41973	1972	THD I AVG MSW	L3	Average Voltage THD calculated over the configured average time	RO	FLOAT32
41974	1973	THD V AVG LSW			RO	
41975	1974	THD V AVG MIN MSW	L3	Minimum Voltage THD calculated over the configured average time	RW	FLOAT32
41976	1975	THD V AVG MIN LSW			RW	
41977	1976	THD V AVG MAX MSW	L3	Maximum Voltage THD calculated over the configured average time	RW	FLOAT32
41978	1977	THD V AVG MAX LSW			RW	
41979	1978	THD V MIN MSW	L3	Minimum Voltage THD since device power up	RW	FLOAT32
41980	1979	THD V MIN LSW			RW	
41981	1980	THD V MAX MSW	L3		RW	FLOAT32

ADDRESS (4x)	ADDRESS OFFSET	REGISTER	PHASE	DESCRIPTION	W/R	TYPE
41982	1981	THD V MAX LSW		Maximum Voltage THD since device power up	RW	
41995	1994	Vsys [V] MSW	3PH	System Voltage (VL1+VL2+VL3)/3	RW	FLOAT32
41996	1995	Vsys [V] LSW			RW	
41997	1996	Isys [A] MSW	3PH	System Current (IL1+IL2+IL3)	RW	FLOAT32
41998	1997	Isys [A] LSW			RW	
42019	2018	COUNTER 1 MSW	-	Digital Input 1 Counter	RW	UNSIGNED INT 32
42020	2019	COUNTER 1 LSW			RW	
42021	2020	COUNTER 2 MSW	-	Digital Input 2 Counter	RW	UNSIGNED INT 32
42022	2021	COUNTER 2 LSW			RW	
42023	2022	E ACTIVE ENERGY (+) [KWh] MSW	L1	Active Energy (Only +) Q1-Q4	RO	FLOAT 32
42024	2023	E ACTIVE ENERGY (+) [KWh] LSW			RO	
42025	2024	E ACTIVE ENERGY (+) [KWh] MSW	L2	Active Energy (Only +) Q1-Q4	RO	FLOAT 32
42026	2025	E ACTIVE ENERGY (+) [KWh] LSW			RO	
42027	2026	E ACTIVE ENERGY (+) [KWh] MSW	L3	Active Energy (Only +) Q1-Q4	RO	FLOAT 32
42028	2027	E ACTIVE ENERGY (+) [KWh] LSW			RO	
42029	2028	E ACTIVE ENERGY (-) [KWh] MSW	L1	Active Energy (Only -) Q2-Q3	RO	FLOAT 32
42030	2029	E ACTIVE ENERGY (-) [KWh] LSW			RO	
42031	2030	E ACTIVE ENERGY (-) [KWh] MSW	L2	Active Energy (Only -) Q2-Q3	RO	FLOAT 32
42032	2031	E ACTIVE ENERGY (-) [KWh] LSW			RO	
42033	2032	E ACTIVE ENERGY (-) [KWh] MSW	L3	Active Energy (Only -) Q2-Q3	RO	FLOAT 32
42034	2033	E ACTIVE ENERGY (-) [KWh] LSW			RO	
42035	2034	E REACTIVE ENERGY (+) [KVARh] MSW	L1	Reactive Energy (Only +) Q1-Q2	RO	FLOAT 32
42036	2035	E REACTIVE ENERGY (+) [KVARh] LSW			RO	
42037	2036	E REACTIVE ENERGY (+) [KVARh] MSW	L2	Reactive Energy (Only +) Q1-Q2	RO	FLOAT 32
42038	2037	E REACTIVE ENERGY (+) [KVARh] LSW			RO	
42039	2038	E REACTIVE ENERGY (+) [KVARh] MSW	L3	Reactive Energy (Only +) Q1-Q2	RO	FLOAT 32
42040	2039	E REACTIVE ENERGY (+) [KVARh] LSW			RO	
42041	2040		L1		RO	FLOAT 32

ADDRESS (4x)	ADDRESS OFFSET	REGISTER	PHASE	DESCRIPTION	W/R	TYPE
42042	2041	E REACTIVE ENERGY (-) [KVARh] MSW		Reactive Energy (Only -) Q3-Q4	RO	
42043	2042	E REACTIVE ENERGY (-) [KVARh] LSW	L2	Reactive Energy (Only -) Q3-Q4	RO	FLOAT32
42044	2043	E REACTIVE ENERGY (-) [KVARh] MSW			RO	
42045	2044	E REACTIVE ENERGY (-) [KVARh] LSW	L3	Reactive Energy (Only -) Q3-Q4	RO	FLOAT32
42046	2045	E REACTIVE ENERGY (-) [KVARh] MSW			RO	
42047	2046	E REACTIVE ENERGY (+)[KVARh] MSW	L1	Reactive Energy (Only +) Q1 [KVARh]	RO	FLOAT32
42048	2047	E REACTIVE ENERGY (+)[KVARh] LSW			RO	
42049	2048	E REACTIVE ENERGY (+)[KVARh] MSW	L2	Reactive Energy (Only +) Q1 [KVARh]	RO	FLOAT32
42050	2049	E REACTIVE ENERGY (+)[KVARh] LSW			RO	
42051	2050	E REACTIVE ENERGY (+)[KVARh] MSW	L3	Reactive Energy (Only +) Q1 [KVARh]	RO	FLOAT32
42052	2051	E REACTIVE ENERGY (+)[KVARh] LSW			RO	
42053	2052	E REACTIVE ENERGY (-) [KVARh] MSW	L1	Reactive Energy (Only -) Q3 [KVARh]	RO	FLOAT32
42054	2053	E REACTIVE ENERGY (-) [KVARh] LSW			RO	
42055	2054	E REACTIVE ENERGY (-) [KVARh] MSW	L2	Reactive Energy (Only -) Q3 [KVARh]	RO	FLOAT32
42056	2055	E REACTIVE ENERGY (-) [KVARh] LSW			RO	
42057	2056	E REACTIVE ENERGY (-) [KVARh] MSW	L3	Reactive Energy (Only -) Q3 [KVARh]	RO	FLOAT32
42058	2057	E REACTIVE ENERGY (-) [KVARh] LSW			RO	
42059	2058	E REACTIVE ENERGY (+) [KVARh] MSW	L1	Reactive Energy (Only +) Q2 [KVARh]	RO	FLOAT32
42060	2059	E REACTIVE ENERGY (+) [KVARh] LSW			RO	
42061	2060	E REACTIVE ENERGY (+) [KVARh] MSW	L2	Reactive Energy (Only +) Q2 [KVARh]	RO	FLOAT32
42062	2061	E REACTIVE ENERGY (+) [KVARh] LSW			RO	
42063	2062	E REACTIVE ENERGY (+) [KVARh] MSW	L3	Reactive Energy (Only +) Q2 [KVARh]	RO	FLOAT32
42064	2063	E REACTIVE ENERGY (+) [KVARh] LSW			RO	
42065	2064	E REACTIVE ENERGY (-) [KVARh] MSW	L1	Reactive Energy (Only -) Q4 [KVARh]	RO	FLOAT32

ADDRESS (4x)	ADDRESS OFFSET	REGISTER	PHASE	DESCRIPTION	W/R	TYPE
42066	2065	E REACTIVE ENERGY (-) [KVARh] LSW			RO	
42067	2066	E REACTIVE ENERGY (-) [KVARh] MSW	L2	Reactive Energy (Only -) Q4 [KVARh]	RO	FLOAT32
42068	2067	E REACTIVE ENERGY (-) [KVARh] LSW			RO	
42069	2068	E REACTIVE ENERGY (-) [KVARh] MSW	L3	Reactive Energy (Only -) Q4 [KVARh]	RO	FLOAT32
42070	2069	E REACTIVE ENERGY (-) [KVARh] LSW			RO	
42071	2070	TOT E ACTIVE ENERGY [KWh] MSW	L1	Total Active Energy [KWh]	RO	FLOAT32
42072	2071	TOT E ACTIVE ENERGY [KWh] LSW			RO	
42073	2072	TOT E ACTIVE ENERGY [KWh] MSW	L2	Total Active Energy [KWh]	RO	FLOAT32
42074	2073	TOT E ACTIVE ENERGY [KWh] LSW			RO	
42075	2074	TOT E ACTIVE ENERGY [KWh] MSW	L3	Total Active Energy [KWh]	RO	FLOAT32
42076	2075	TOT E ACTIVE ENERGY [KWh] LSW			RO	
42077	2076	TOT E REACTIVE ENERGY [KVARh]MSW	L1	Total Reactive Energy [KVARh]	RO	FLOAT32
42078	2077	TOT E REACTIVE ENERGY [KVARh]LSW			RO	
42079	2078	TOT E REACTIVE ENERGY [KVARh]MSW	L2	Total Reactive Energy [KVARh]	RO	FLOAT32
42080	2079	TOT E REACTIVE ENERGY [KVARh]LSW			RO	
42081	2080	TOT E REACTIVE ENERGY [KVARh]MSW	L3	Total Reactive Energy [KVARh]	RO	FLOAT32
42082	2081	TOT E REACTIVE ENERGY [KVARh]LSW			RO	
42083	2082	TOT E APPARENT ENERGY [KVARh] MSW	L1	Total Apparent Energy [VAh]	RO	FLOAT32
42084	2083	TOT E APPARENT ENERGY [KVARh] LSW			RO	
42085	2084	TOT E APPARENT ENERGY [KVARh] MSW	L2	Total Apparent Energy [VAh]	RO	FLOAT32
42086	2085	TOT E APPARENT ENERGY [KVARh] LSW			RO	
42087	2086	TOT E APPARENT ENERGY [KVARh] MSW	L3	Total Apparent Energy [VAh]	RO	FLOAT32
42088	2087	TOT E APPARENT ENERGY [KVARh] LSW			RO	
42089	2088	E ACTIVE ENERGY (+) [KWh] MSW	3PH		RO	FLOAT32

ADDRESS (4x)	ADDRESS OFFSET	REGISTER	PHASE	DESCRIPTION	W/R	TYPE
42090	2089	E ACTIVE ENERGY (+) [KWh] LSW		Active Energy (Only +) Q1-Q4 [KWh]	RO	
42091	2090	E ACTIVE ENERGY (-) [KWh] MSW	3PH	Active Energy (Only -) Q2-Q3 [KWh]	RO	FLOAT32
42092	2091	E ACTIVE ENERGY (-) [KWh] LSW			RO	
42093	2092	E REACTIVE ENERGY (+) [KVARh] MSW	3PH	Reactive Energy (Only +) Q1-Q2 [KWh]	RO	FLOAT32
42094	2093	E REACTIVE ENERGY (+) [KVARh] LSW			RO	
42095	2094	E REACTIVE ENERGY (-) [KVARh] MSW	3PH	Reactive Energy (Only -) Q3-Q4 [KWh]	RO	FLOAT32
42096	2095	E REACTIVE ENERGY (-) [KVARh] LSW			RO	
42097	2096	TOT E ACTIVE ENERGY [KWh] MSW	3PH	Total Active Energy [KWh]	RO	FLOAT32
42098	2097	TOT E ACTIVE ENERGY [KWh] LSW			RO	
42099	2098	TOT E REACTIVE ENERGY [KVARh] MSW	3PH	Total Reactive Energy [KVARh]	RO	FLOAT32
42100	2099	TOT E REACTIVE ENERGY [KVARh] LSW			RO	
42101	2100	TOT E APPARENT ENERGY [KVAh] MSW	3PH	Total Apparent Energy [KVAh]	RO	FLOAT32
42102	2101	TOT E APPARENT ENERGY [KVAh] LSW			RO	
42103	2102	TOT E REACTIVE ENERGY (+) ABSORBED [KVARh] MSW	3PH	Total Absorbed Reactive Energy (+) [KVARh]	RO	FLOAT32
42104	2103	TOT E REACTIVE ENERGY (+) ABSORBED [KVARh] LSW			RO	
42105	2104	TOT E REACTIVE ENERGY (-) ABSORBED [KVARh] MSW	3PH	Total Absorbed Reactive Energy (-) [KVARh]	RO	FLOAT32
42106	2105	TOT E REACTIVE ENERGY (-) ABSORBED [KVARh] LSW			RO	
42107	2106	TOT E REACTIVE ENERGY (+) DELIVERED [KVARh] MSW	3PH	Total Delivered Reactive Energy (+) [KVARh]	RO	FLOAT32
42108	2107	TOT E REACTIVE ENERGY (+) DELIVERED [KVARh] LSW			RO	
42109	2108	TOT E REACTIVE ENERGY (-) DELIVERED [KVARh] MSW	3PH	Total Delivered Reactive Energy (-) [KVARh]	RO	FLOAT32
42110	2109	TOT E REACTIVE ENERGY (-) DELIVERED [KVARh] LSW			RO	
45075	5074	DEMAND VALUE [min]	-	Value of the demand value for the average [minutes]. The modification is enabled after a reboot.	RW*	UNSIGNED INT 32

## 20. **PROFINET IO COMMUNICATION PROTOCOL (R203-P MODELS ONLY)**

Type of protocol: Class A Device, Cyclic Real-time (RT) and Acyclic Data

### 20.1. **CREATING A PROJECT WITH SIEMENS PLC (TIA PORTAL 16) (R203-P MODELS ONLY)**

Creating a new project:

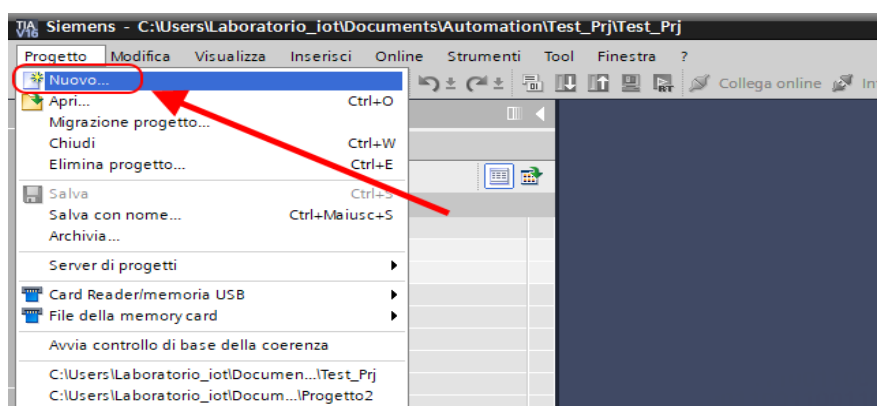

## 20.1.1. INSTALLING THE GSDML FILE

Install the GSDML file of the Seneca product

(it is possible to obtain the file on the web page of the device on the [www.seneca.it](http://www.seneca.it) site):

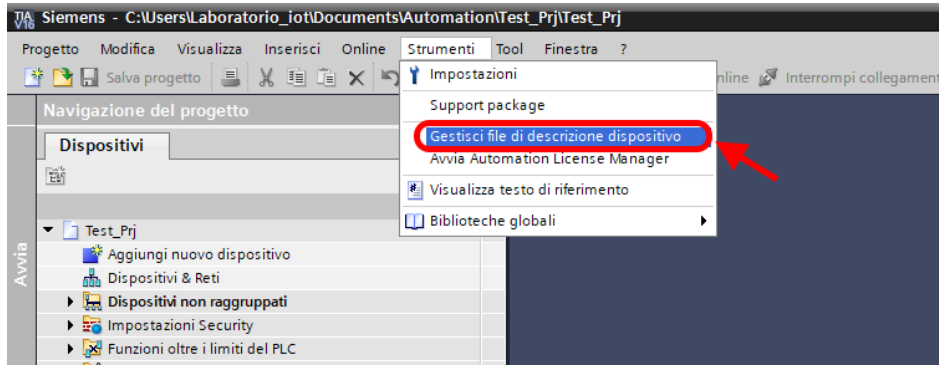

Point to the directory where the file is and press OK, then the list of GSD files in the folder will appear:

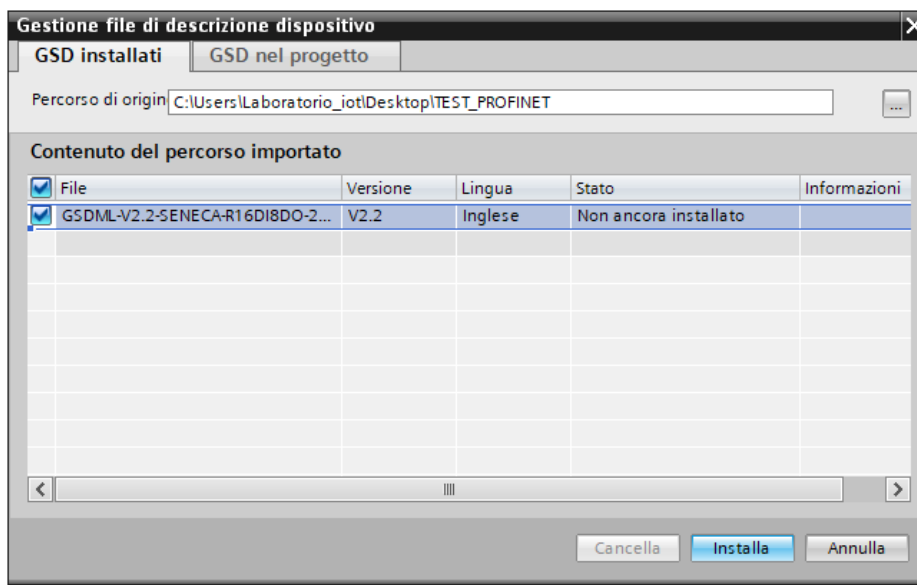

Click on "install".

## 20.1.2. INSERTION OF THE SIEMENS PLC IN THE PROJECT

Now insert the Siemens PLC (in our example a SIEMATIC S7 1200), click on "Add new device ...":

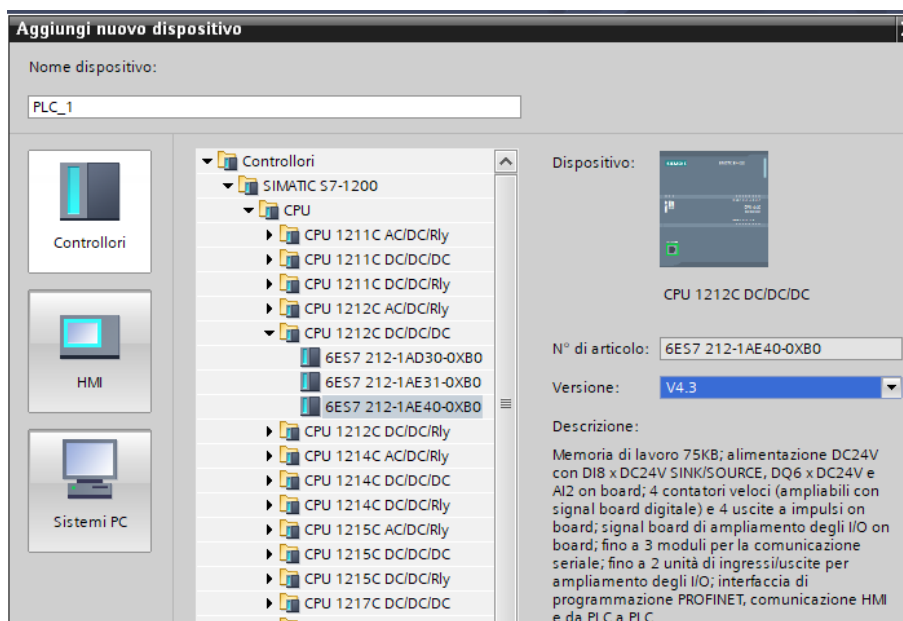
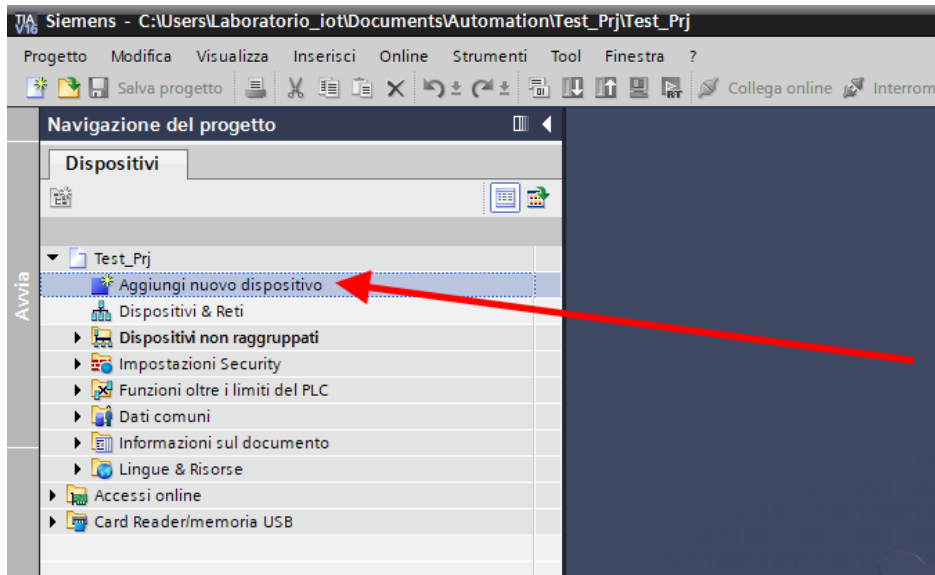



Confirm and the PLC will be added to the rack:

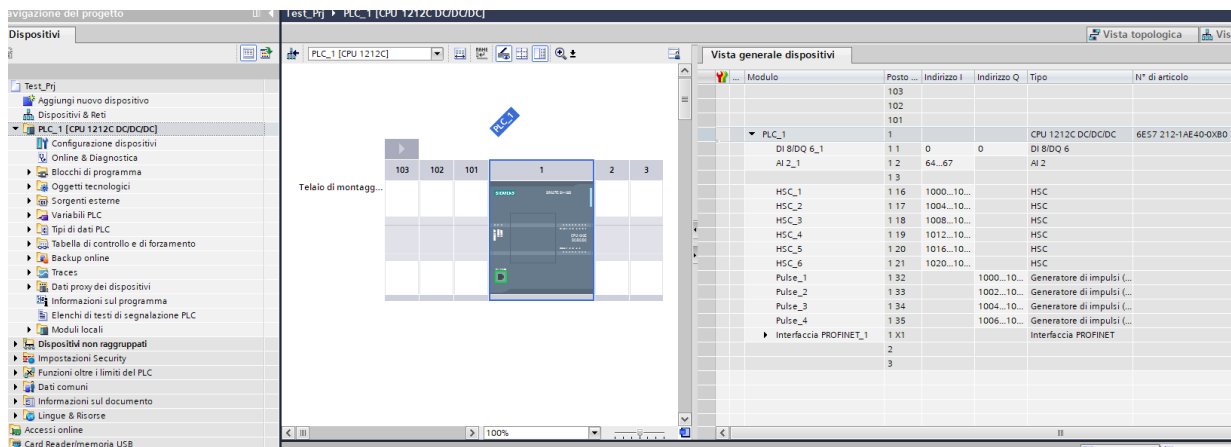

Now click on the PLC and select Profinet interface -> Ethernet addresses

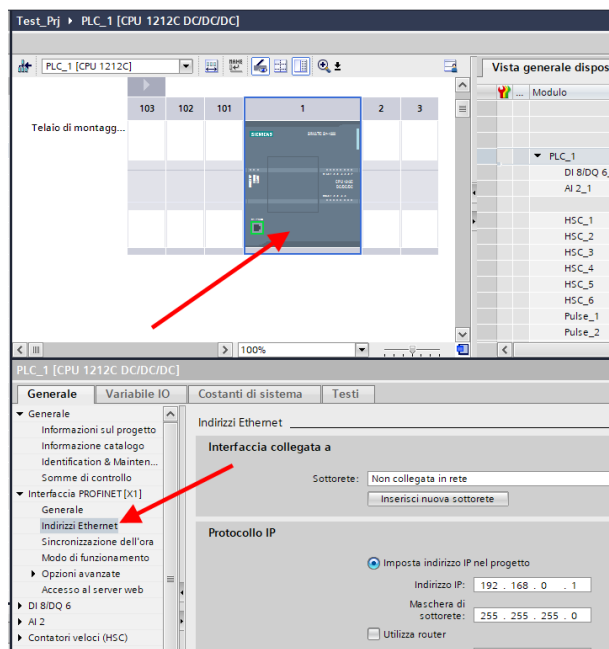

Set the IP you want (in this case 192.168.90.44) and the PLC subnet:

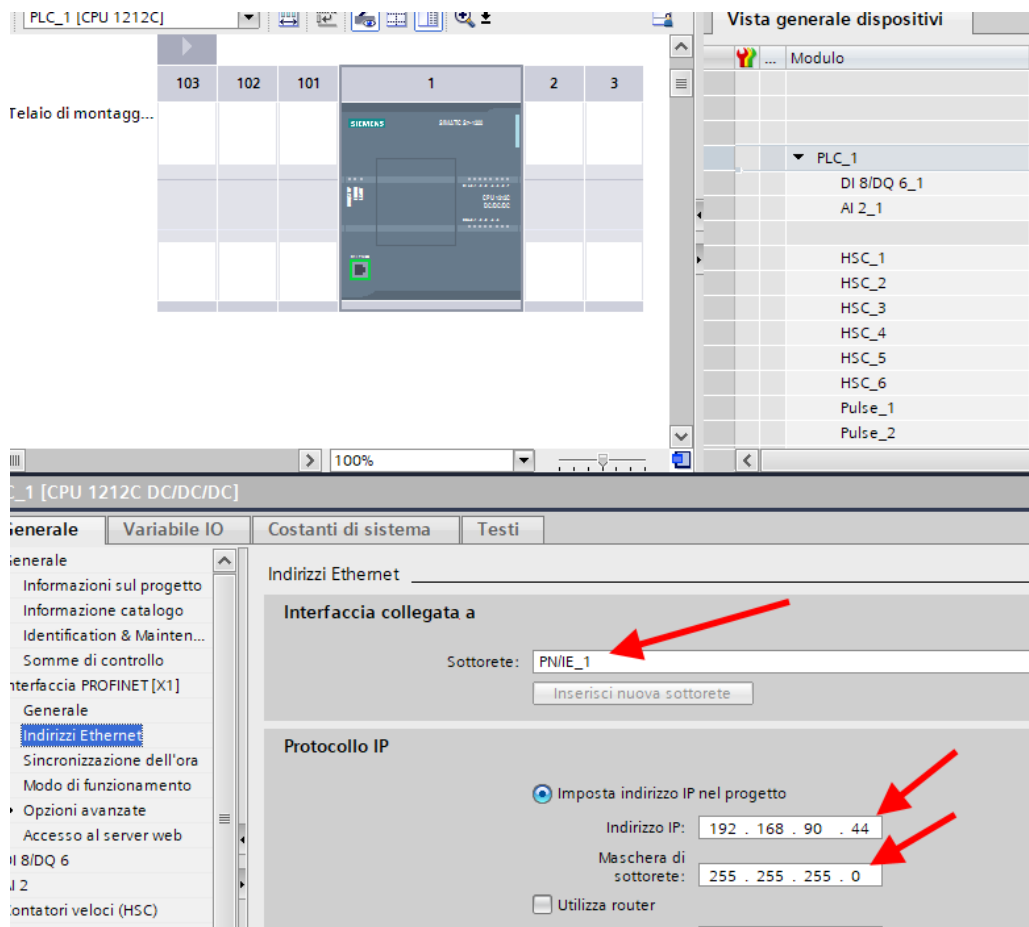

Move on to the network view:

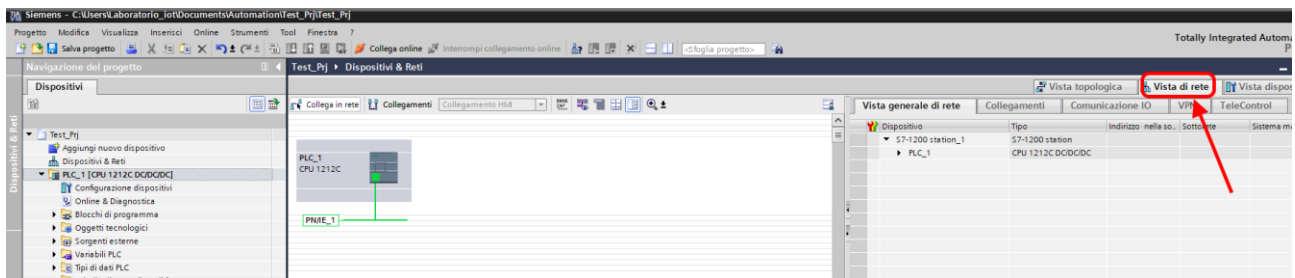

### 20.1.3. *INSERTION OF THE PROFINET SENECA IO*

On the right select "Hardware Catalogue" and then under "Additional Field Equipment" -> PROFINET IO -> Sensors -> Seneca S.R.L. -> Seneca R-Series Devices -> R-203-P Ethernet I/O

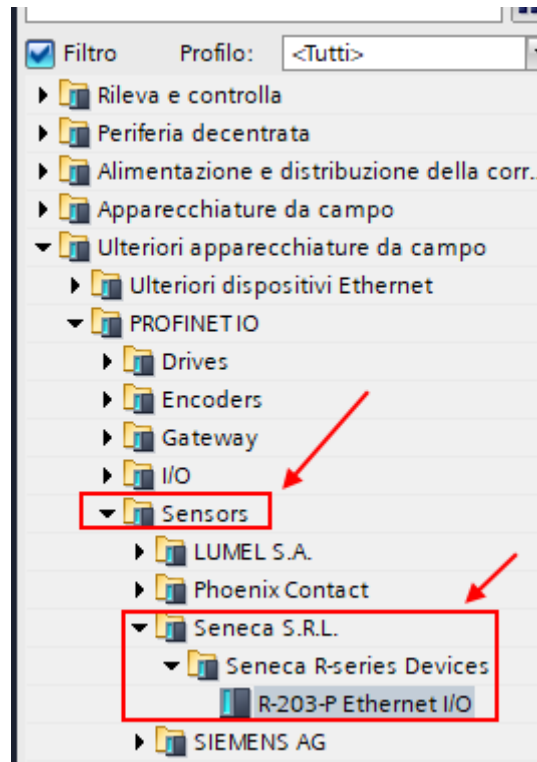

Drag the device to the network view:

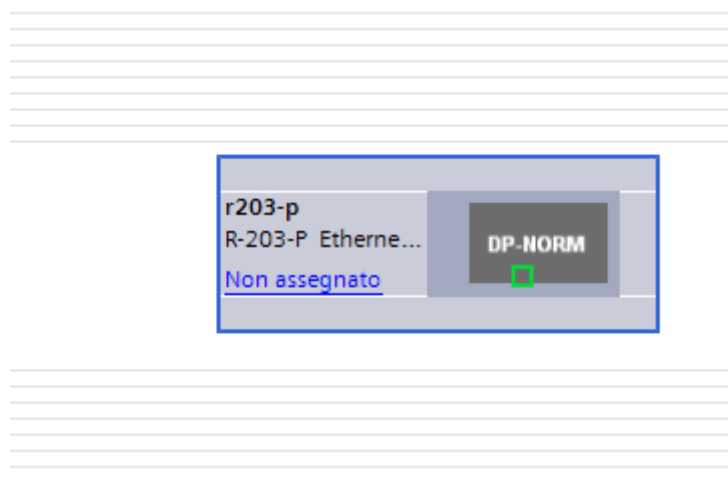

Now associate it to the PLC by clicking with the left mouse on "Not assigned" and then select the PLC:

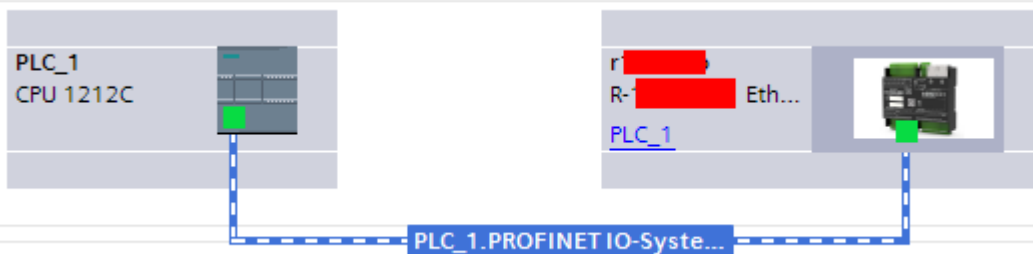
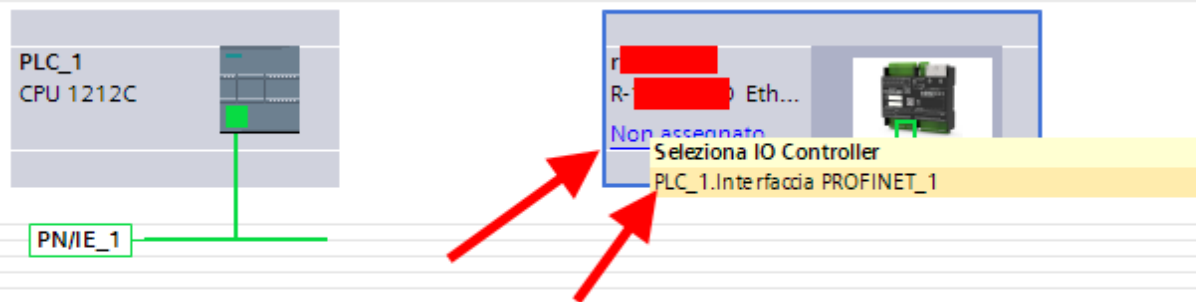

Click twice on the Seneca device and configure the IP address here too (for example 192.168.90.48):

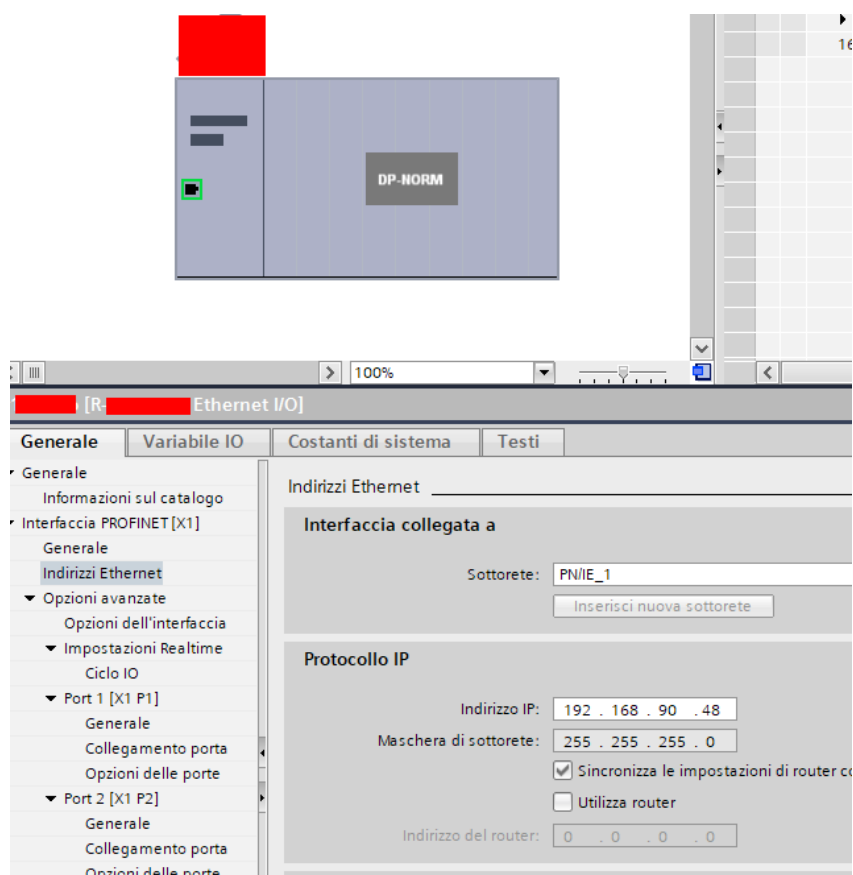

In Profinet the devices are identified by their name, so right click on the Seneca device and select "Assign device name"

## **ATTENTION!**

**AVOID INSERTING SPECIAL CHARACTERS IN THE PROFINET NAME OF THE DEVICE**

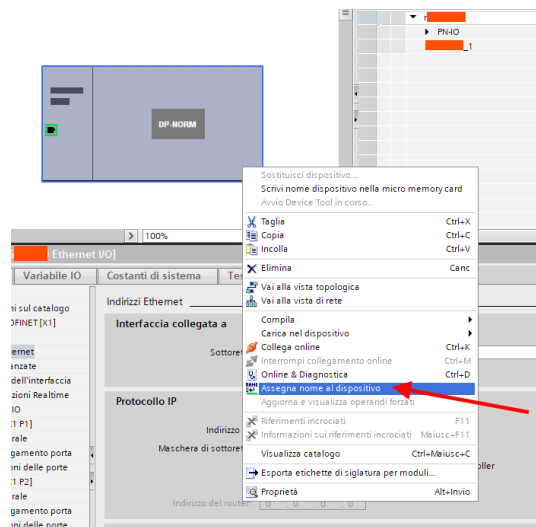

Scan the network with "Update list" and set (if necessary) the device name with "Assign name".

## 20.1.4. CONFIGURATION OF THE PARAMETERS OF THE SENECA DEVICE

It is also possible to directly configure the device IO without any external software.  
To configure the device, click on the IO so that the "Unit parameters" appear:

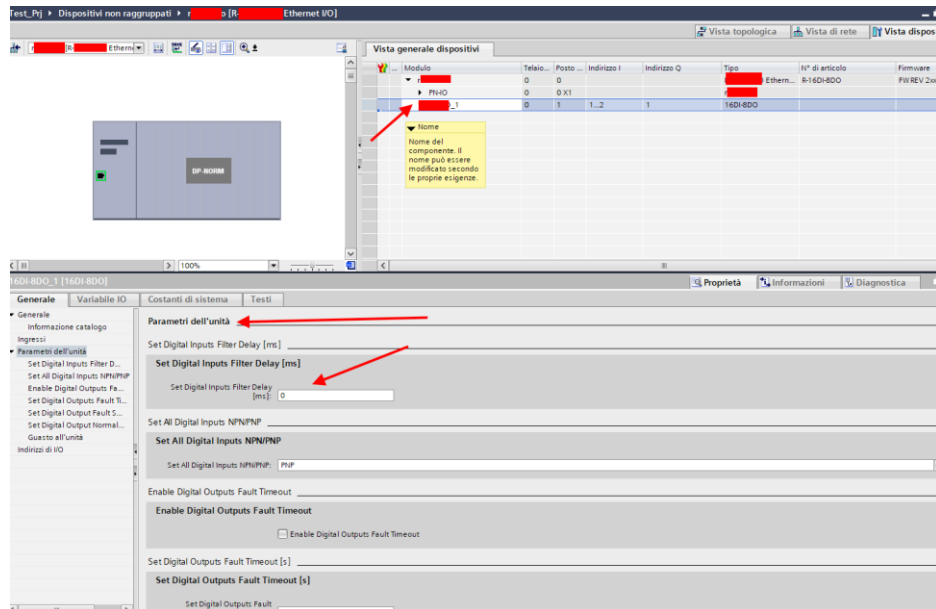

At the next start, the PLC will send the desired configuration to the device.

### 20.1.5. **CONFIGURATION PARAMETERS OF THE GSDML FILE**

#### **CONNECTION TYPE**

Sets the type of connection to make.

#### **TA TYPE**

Selects the type of sensor and the value of the TA secondary to be used between:

TA with current output

TA with MV output

Rogowski sensor

#### **TA RATIO**

Sets any TA ratio, the value to enter is related to the primary, example:

If a 50/5 TA has been installed, the value 50 must be entered as primary with the value 5 on the "TA TYPE" parameter.

#### **TV TYPE**

Sets the type of voltage transformer

#### **TV RATIO**

Sets the possible TV ratio

#### **NETWORK FREQUENCY [Hz]**

Sets the system to 50 or 60 Hz.

#### **AVERAGE POWER WINDOW**

Sets the time on which to measure the average values

#### **USER CALIBRATION VOLTAGE**

Sets a possible multiplication coefficient for the voltage measurement.

#### **USER CALIBRATION CURRENT**

Sets a possible multiplication coefficient for the current measurement.

#### **CUTOFF CURRENT [A]**

Sets a current value (on the primary) below which counters are stopped.

#### **USER CALIBRATION ACTIVE ENERGY**

Sets a possible multiplication coefficient for the active energy.

#### **USER CALIBRATION REACTIVE ENERGY**

Sets a possible multiplication coefficient for the reactive energy.

#### **AO MODE**

Sets whether the analog output is configured in Voltage [0V...10V] or Current [0mA...20mA].



## 20.1.6. R203-P I/O DATA

You can now choose which variable groups to publish in Profinet.  
Once the device inserted the following will appear:

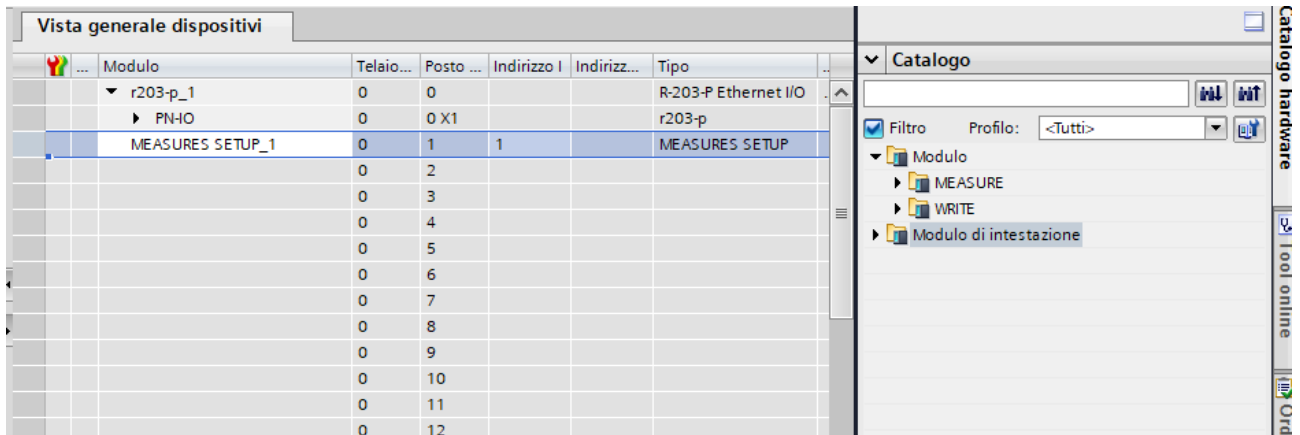

MEASURE\_SETUP is a group of variables that is always present, while on the right there are “MEASURE” and “WRITE” variables.

You can add up to 15 variable groups.

The variable groups are optional, those that can be added are:

**MEASURE SETUP (Always present)**

Provides general information on the status of the inputs and the device:

Name	Data Type	Display as Bits	Length [Bytes]
<b>STATUS</b>	Unsigned8	Bit 0: CYCLIC PHASE SENSOR ERROR Bit 1: CURRENT CUT OFF Bit 2: CURRENT ERROR L1 Bit 3: CURRENT ERROR L2 Bit 4: CURRENT ERROR L3 Bit 5: LINE 1 VOLTAGE/CURRENT CONNECTION ERROR Bit 6: LINE 2 VOLTAGE/CURRENT CONNECTION ERROR Bit 7: LINE 3 VOLTAGE/CURRENT CONNECTION ERROR	1

For more information on the meaning of these Boolean values, refer to the chapter 14.

**VOLTAGE**

Provides the values of the phase-to-line and star voltages:

Name	Data Type	Display as Bits	Length [Bytes]
<b>VL1L2</b>	Float32	No	4
<b>VL2L3</b>	Float32	No	4
<b>VL3L1</b>	Float32	No	4
<b>VL1N</b>	Float32	No	4
<b>VL2N</b>	Float32	No	4
<b>VL3N</b>	Float32	No	4

### **CURRENT**

Provides the values of the phase and neutral currents in [A]:

Name	Data Type	Display as Bits	Length [Bytes]
IL1	Float32	<input type="checkbox"/> No	4
IL2	Float32	<input type="checkbox"/> No	4
IL3	Float32	<input type="checkbox"/> No	4
IN	Float32	<input type="checkbox"/> No	4

### **ACTIVE REACTIVE APPARENT TOTAL POWER**

Provides the total active, reactive and apparent power values in [KW], [KVAR], [KVA]:

Name	Data Type	Display as Bits	Length [Bytes]
ACTIVE POWER L1	Float32	<input type="checkbox"/> No	4
ACTIVE POWER L2	Float32	<input type="checkbox"/> No	4
ACTIVE POWER L3	Float32	<input type="checkbox"/> No	4
REACTIVE POWER L1	Float32	<input type="checkbox"/> No	4
REACTIVE POWER L2	Float32	<input type="checkbox"/> No	4
REACTIVE POWER L3	Float32	<input type="checkbox"/> No	4
APPARENT POWER L1	Float32	<input type="checkbox"/> No	4
APPARENT POWER L2	Float32	<input type="checkbox"/> No	4
APPARENT POWER L3	Float32	<input type="checkbox"/> No	4
TOTAL ACTIVE POWER	Float32	<input type="checkbox"/> No	4
TOTAL REACTIVE POWER	Float32	<input type="checkbox"/> No	4
TOTAL APPARENT POWER	Float32	<input type="checkbox"/> No	4

## ANGLE

Provides the values of the vector phase shift in [°]

Name	Data Type	Display as Bits	Length [Bytes]
ANGLE VI L1	Float32	<input type="checkbox"/> No	4
ANGLE VI L2	Float32	<input type="checkbox"/> No	4
ANGLE VI L3	Float32	<input type="checkbox"/> No	4
ANGLE VI L1 L2	Float32	<input type="checkbox"/> No	4
ANGLE VI L2 L3	Float32	<input type="checkbox"/> No	4
ANGLE VI L3 L1	Float32	<input type="checkbox"/> No	4

## POWER FACTOR

Provides the power factor values:

Name	Data Type	Display as Bits	Length [Bytes]
POWER FACTOR L1	Float32	<input type="checkbox"/> No	4
POWER FACTOR L2	Float32	<input type="checkbox"/> No	4
POWER FACTOR L3	Float32	<input type="checkbox"/> No	4
POWER FACTOR TOTAL	Float32	<input type="checkbox"/> No	4

**FREQUENCY PERIOD**

Provides frequency [Hz] and period [ms] values:

Name	Data Type	Display as Bits	Length [Bytes]
FREQUENCY L1	Float32	<input type="checkbox"/> No	4
FREQUENCY L2	Float32	<input type="checkbox"/> No	4
FREQUENCY L3	Float32	<input type="checkbox"/> No	4
PERIOD L1	Float32	<input type="checkbox"/> No	4
PERIOD L2	Float32	<input type="checkbox"/> No	4
PERIOD L3	Float32	<input type="checkbox"/> No	4

**THD**

Provides the Total Harmonic Distortion in [%]

Name	Data Type	Display as Bits	Length [Bytes]
THD V L1	Float32	<input type="checkbox"/> No	4
THD V L2	Float32	<input type="checkbox"/> No	4
THD V L3	Float32	<input type="checkbox"/> No	4
THD I L1	Float32	<input type="checkbox"/> No	4
THD I L2	Float32	<input type="checkbox"/> No	4
THD I L3	Float32	<input type="checkbox"/> No	4

**AVERAGE**

Provides the values averaged over the demand time configured in [V], [A], [KW], [KVAR], [KVA]

Name	Data Type	Display as Bits	Length [Bytes]
AVG V L1	Float32	<input type="checkbox"/> No	4
AVG V L2	Float32	<input type="checkbox"/> No	4
AVG V L3	Float32	<input type="checkbox"/> No	4
AVG I L1	Float32	<input type="checkbox"/> No	4
AVG I L2	Float32	<input type="checkbox"/> No	4
AVG I L3	Float32	<input type="checkbox"/> No	4
AVG ACTIVE POWER 3PH	Float32	<input type="checkbox"/> No	4
AVG REACTIVE POWER 3PH	Float32	<input type="checkbox"/> No	4
AVG APPARENT POWER 3PH	Float32	<input type="checkbox"/> No	4

**MIN**

Provides the minimum values of the measurements in [V], [A], [KW], [KVAR], [KVA]:

Name	Data Type	Display as Bits	Length [Bytes]
MIN V L1	Float32	<input type="checkbox"/> No	4
MIN V L2	Float32	<input type="checkbox"/> No	4
MIN V L3	Float32	<input type="checkbox"/> No	4
MIN I L1	Float32	<input type="checkbox"/> No	4
MIN I L2	Float32	<input type="checkbox"/> No	4
MIN I L3	Float32	<input type="checkbox"/> No	4
MIN ACTIVE POWER 3PH	Float32	<input type="checkbox"/> No	4
MIN REACTIVE POWER 3PH	Float32	<input type="checkbox"/> No	4
MIN APPARENT POWER 3PH	Float32	<input type="checkbox"/> No	4

**MAX**

Provides maximum measurement values in [V], [A], [KW], [KVAR], [KVA]:

Name	Data Type	Display as Bits	Length [Bytes]
MAX V L1	Float32	<input type="checkbox"/> No	4
MAX V L2	Float32	<input type="checkbox"/> No	4
MAX V L3	Float32	<input type="checkbox"/> No	4
MAX I L1	Float32	<input type="checkbox"/> No	4
MAX I L2	Float32	<input type="checkbox"/> No	4
MAX I L3	Float32	<input type="checkbox"/> No	4
MAX ACTIVE POWER 3PH	Float32	<input type="checkbox"/> No	4
MAX REACTIVE POWER 3PH	Float32	<input type="checkbox"/> No	4
MAX APPARENT POWER 3PH	Float32	<input type="checkbox"/> No	4

**ENERGY ACTIVE PHASE**

Provides the values of phase active energy separated by quadrants, positive and negative and total in [KWh]:

Name	Data Type	Display as Bits	Length [Bytes]
ENERGY ACTIVE(+) Q1-Q4 L1	Float32	<input type="checkbox"/> No	4
ENERGY ACTIVE(+) Q1-Q4 L2	Float32	<input type="checkbox"/> No	4
ENERGY ACTIVE(+) Q1-Q4 L3	Float32	<input type="checkbox"/> No	4
ENERGY ACTIVE(-) Q2-Q3 L1	Float32	<input type="checkbox"/> No	4
ENERGY ACTIVE(-) Q2-Q3 L2	Float32	<input type="checkbox"/> No	4
ENERGY ACTIVE(-) Q2-Q3 L3	Float32	<input type="checkbox"/> No	4
ENERGY ACTIVE TOTAL L1	Float32	<input type="checkbox"/> No	4
ENERGY ACTIVE TOTAL L2	Float32	<input type="checkbox"/> No	4
ENERGY ACTIVE TOTAL L3	Float32	<input type="checkbox"/> No	4

**ENERGY ACTIVE 3PH PHASE**

Provides the values of the positive and negative and total three-phase active energy in [KWh]:

Name	Data Type	Display as Bits	Length [Bytes]
ENERGY ACTIVE 3PH (+) Q1-Q4	Float32	<input type="checkbox"/> No	4
ENERGY ACTIVE 3PH (-) Q2-Q3	Float32	<input type="checkbox"/> No	4
ENERGY ACTIVE TOTAL 3PH	Float32	<input type="checkbox"/> No	4



**ENERGY REACTIVE Q1-Q2**

Provides positive reactive energy values in [KVARh]:

Name	Data Type	Display as Bits	Length [Bytes]
ENERGY REACTIVE(+) Q1-Q2 L1	Float32	<input type="checkbox"/> No	4
ENERGY REACTIVE(+) Q1-Q2 L2	Float32	<input type="checkbox"/> No	4
ENERGY REACTIVE(+) Q1-Q2 L3	Float32	<input type="checkbox"/> No	4
ENERGY ACTIVE 3PH (+) Q1-Q2	Float32	<input type="checkbox"/> No	4

**ENERGY REACTIVE Q3-Q4**

Provides the values of the negative reactive energy in [KVARh]:

Name	Data Type	Display as Bits	Length [Bytes]
ENERGY REACTIVE(-) Q3-Q4 L1	Float32	<input type="checkbox"/> No	4
ENERGY REACTIVE(-) Q3-Q4 L2	Float32	<input type="checkbox"/> No	4
ENERGY REACTIVE(-) Q3-Q4 L3	Float32	<input type="checkbox"/> No	4
ENERGY ACTIVE 3PH (-) Q3-Q4	Float32	<input type="checkbox"/> No	4

**ENERGY REACTIVE Q1**

Provides the Q1 quadrant reactive energy values of each phase in [KVARh]:

Name	Data Type	Display as Bits	Length [Bytes]
ENERGY REACTIVE(+) Q1 L1	Float32	<input type="checkbox"/> No	4
ENERGY REACTIVE(+) Q1 L2	Float32	<input type="checkbox"/> No	4
ENERGY REACTIVE(+) Q1 L3	Float32	<input type="checkbox"/> No	4

**ENERGY REACTIVE Q2**

Provides the reactive energy values of the Q2 quadrant of each phase in [KVARh]:

Name	Data Type	Display as Bits	Length [Bytes]
ENERGY REACTIVE(-) Q2 L1	Float32	<input type="checkbox"/> No	4
ENERGY REACTIVE(-) Q2 L2	Float32	<input type="checkbox"/> No	4
ENERGY REACTIVE(-) Q2 L3	Float32	<input type="checkbox"/> No	4

**ENERGY REACTIVE Q3**

Provides the Q3 quadrant reactive energy values of each phase in [KVARh]:

Name	Data Type	Display as Bits	Length [Bytes]
ENERGY REACTIVE(+) Q3 L1	Float32	<input type="checkbox"/> No	4
ENERGY REACTIVE(+) Q3 L2	Float32	<input type="checkbox"/> No	4
ENERGY REACTIVE(+) Q3 L3	Float32	<input type="checkbox"/> No	4

**ENERGY REACTIVE Q4**

Provides the reactive energy values of the Q4 quadrant of each phase in [KVARh]:

Name	Data Type	Display as Bits	Length [Bytes]
ENERGY REACTIVE(-) Q4 L1	Float32	<input type="checkbox"/> No	4
ENERGY REACTIVE(-) Q4 L2	Float32	<input type="checkbox"/> No	4
ENERGY REACTIVE(-) Q4 L3	Float32	<input type="checkbox"/> No	4

### **ENERGY REACTIVE TOTAL**

Provides the total reactive energy values of each phase and three-phase in [KVARh]:

Name	Data Type	Display as Bits	Length [Bytes]
ENERGY REACTIVE TOTAL L1	Float32	<input type="checkbox"/> No	4
ENERGY REACTIVE TOTAL L2	Float32	<input type="checkbox"/> No	4
ENERGY REACTIVE TOTAL L3	Float32	<input type="checkbox"/> No	4
ENERGY REACTIVE TOTAL 3PH	Float32	<input type="checkbox"/> No	4

### **ENERGY APPARENT TOTAL**

Provides the total apparent energy values of each phase and three-phase in [KVARh]:

Name	Data Type	Display as Bits	Length [Bytes]
ENERGY APPARENT TOTAL L1	Float32	<input type="checkbox"/> No	4
ENERGY APPARENT TOTAL L2	Float32	<input type="checkbox"/> No	4
ENERGY APPARENT TOTAL L3	Float32	<input type="checkbox"/> No	4
ENERGY APPARENT TOTAL 3PH	Float32	<input type="checkbox"/> No	4

### **ENERGY REACTIVE ABSORBED TOTAL**

Provides the values of the total absorbed reactive energy in [KVARh]:

Name	Data Type	Display as Bits	Length [Bytes]
ENERGY REACTIVE ABSORBED (+) TOTAL 3PH	Float32	<input type="checkbox"/> No	4
ENERGY REACTIVE ABSORBED (-) TOTAL 3PH	Float32	<input type="checkbox"/> No	4

### ENERGY REACTIVE DELIVERED TOTAL

Provides the values of the total reactive energy delivered in [KVARh]:

Name	Data Type	Display as Bits	Length [Bytes]
ENERGY REACTIVE DELIVERED (+) TOTAL 3PH	Float32	<input type="checkbox"/> No	4
ENERGY REACTIVE DELIVERED (-) TOTAL 3PH	Float32	<input type="checkbox"/> No	4

### DI

Provides the two analog input values:

Name	Data Type	Display as Bits	Length [Bytes]
DIGITAL INPUT	Unsigned8	Bit 0: DIN.1 Bit 1: DIN.2 Bit 2: NONE Bit 3: NONE Bit 4: NONE Bit 5: NONE Bit 6: NONE Bit 7: NONE	1

### DO

Status (writable) with the value of the two digital outputs:

Name	Data Type	Display as Bits	Length [Bytes]
DO	Unsigned8	Bit 0: DOUT.1 Bit 1: DOUT.2 Bit 2: NONE Bit 3: NONE Bit 4: NONE Bit 5: NONE Bit 6: NONE Bit 7: NONE	1

### AO

Status (writable) with the value of the analog output in [mA] or [V]:

Name	Data Type	Display as Bits	Length [Bytes]
AO VALUE	Float32	<input type="checkbox"/> No	4

### NETWORK FREQUENCY

It allows you to change in real time the frequency and operation from 0 = 50Hz to 1= 60 Hz

Name	Data Type	Display as Bits	Length [Bytes]
NETWORK FREQUENCY VALUE	Unsigned8	<input type="checkbox"/> No	1

### COMMAND VALUE

It allows you to send commands to R203:

COMMAND CODE(decimal)	ACTION
260	Reset MIN/MAX
259	Reset AVG
261	Reset Energy Counters
40986	Load value in CMD_AUX register to COUNTER1
41002	Load value in CMD_AUX register to COUNTER2

Name	Data Type	Display as Bits	Length [Bytes]
COMMAND VALUE	Unsigned16	<input type="checkbox"/> No	2

### COMMAND AUX

Additional COMMAND Register to send special commands to R203:

Name	Data Type	Display as Bits	Length [Bytes]
COMMAND AUX VALUE	Unsigned32	<input type="checkbox"/> No	4

Now compile, send the project and go online with the PLC.

## 21. **ETHERNET/IP COMMUNICATION PROTOCOL (R203- E MODELS ONLY)**

EtherNet/IP (Ethernet Industrial Protocol) is an open field bus based on CIP (Common Industrial Protocol), developed by Rockwell Automation and ODVA (Open DeviceNet Vendor Association).

### 21.1. **CREATING A PROJECT WITH PLC ALLEN BRADLEY/ROCKWELL (RS-LOGIX5000 / STUDIO 5000 LOGIX DESIGNER 35.00.00)**

Once the PLC has been added to the project, import the EDS file of the R203 device via the Tools-> EDS Hardware Installation Tool menu:

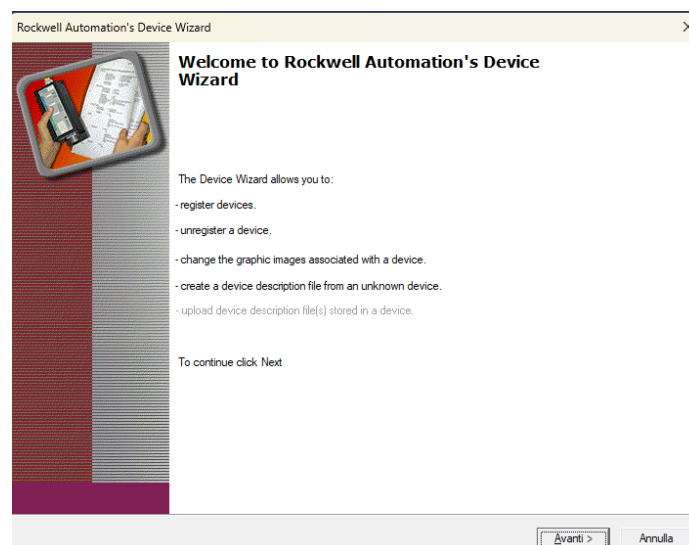
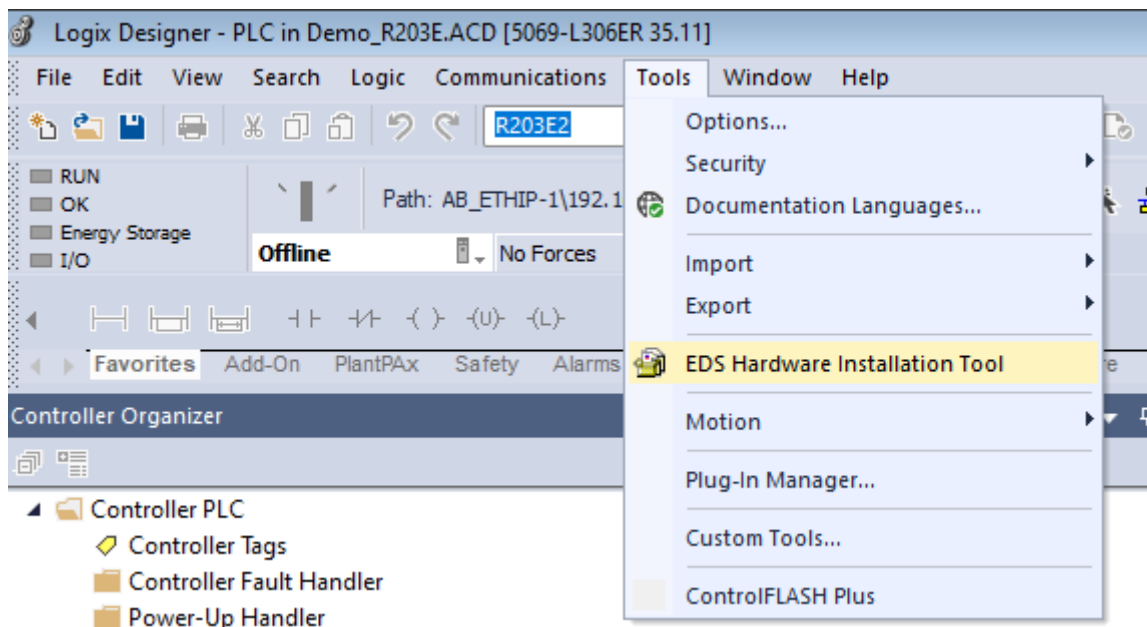

Press “Next”, and select Add a new device:

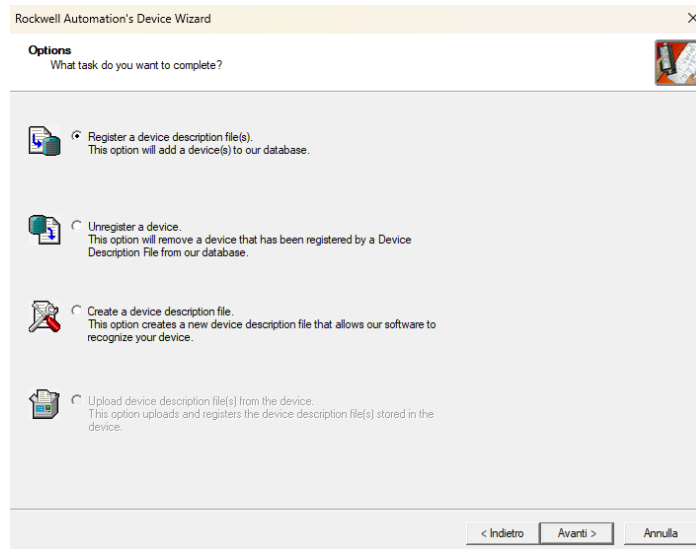

Select to register a single device and select the “R203-P.eds” file

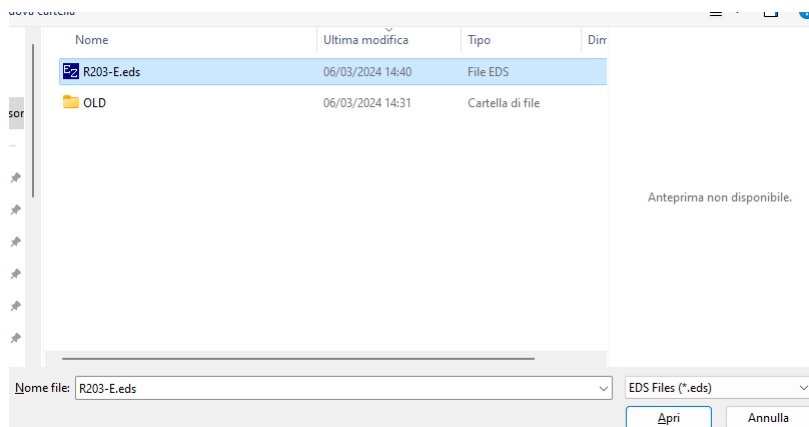
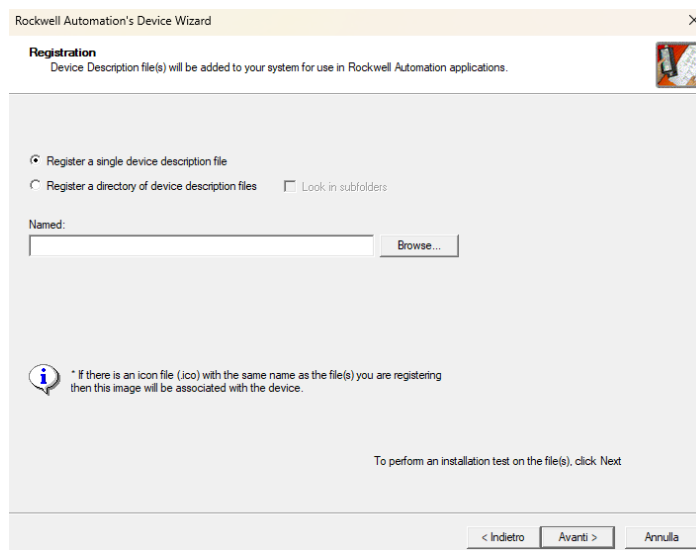

Select “Open” and then “Next”:

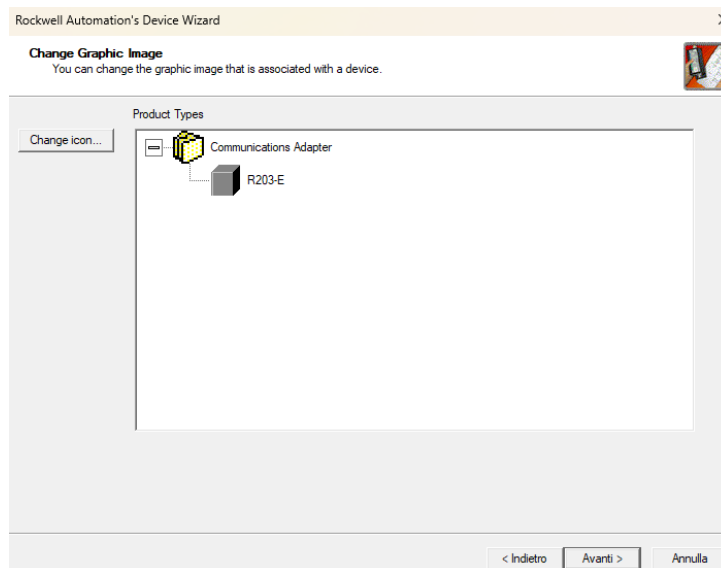
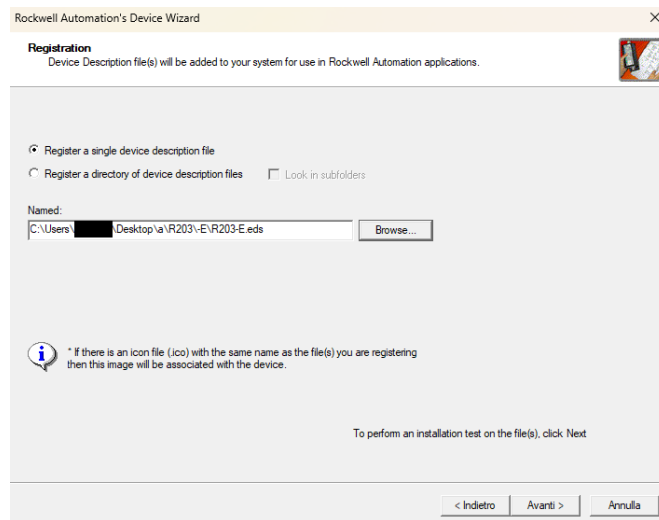

At this point the R203-E product has been entered into the device database.



Now go with the mouse over the ethernet port of the PLC connected to the device and with the right button select "New Module...":

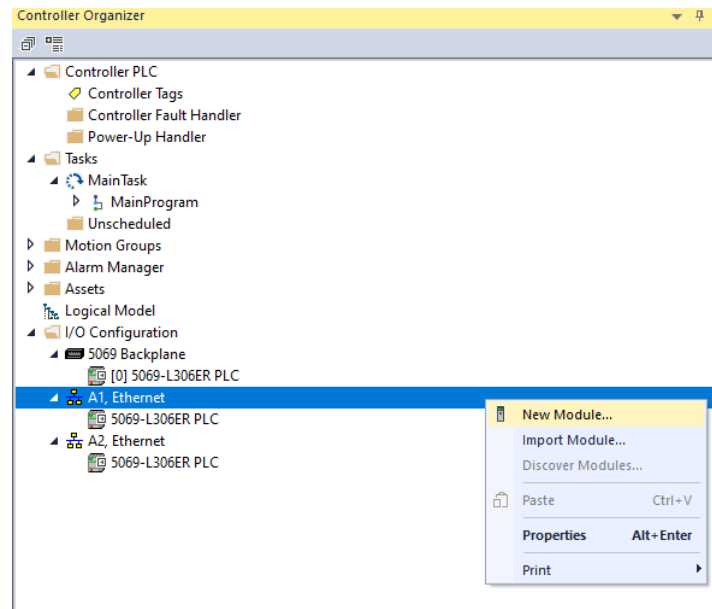

Now select the R203-E device:

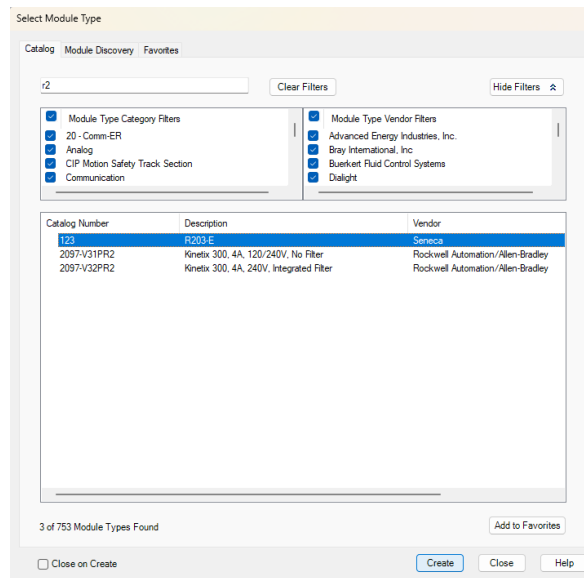

Give the device a name and enter its IP address:

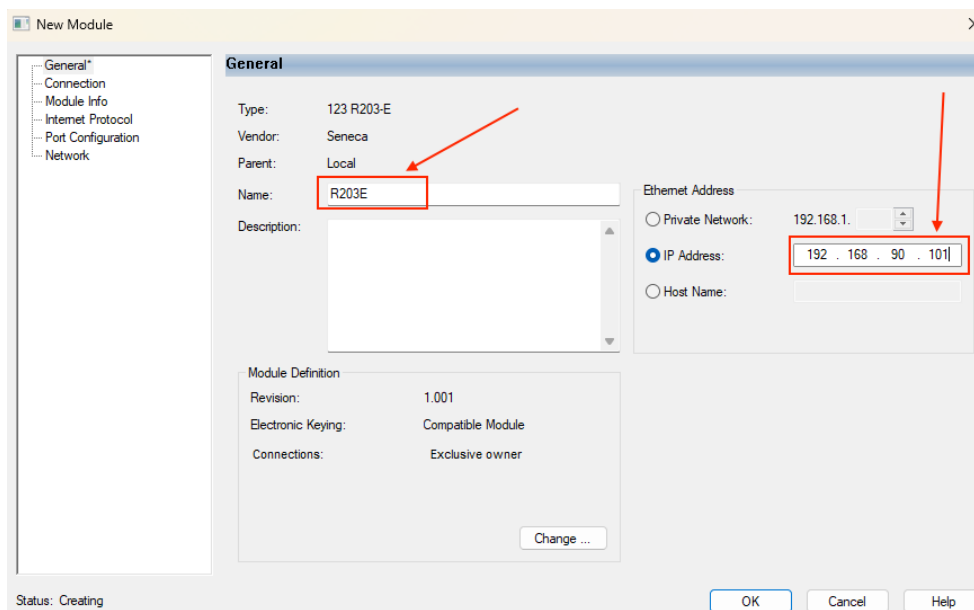

By confirming with OK the device is added:

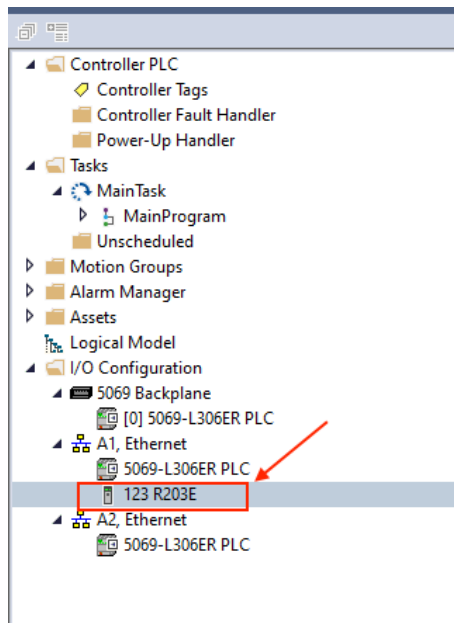

To simplify the acquisition of measurements and sending records to the device, you import the User Data Defined relating to R203-E:

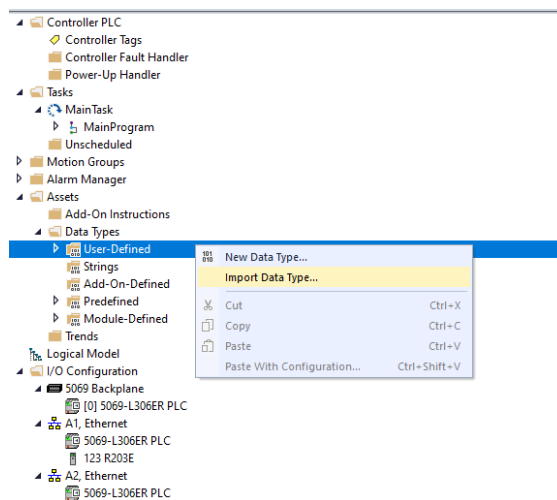

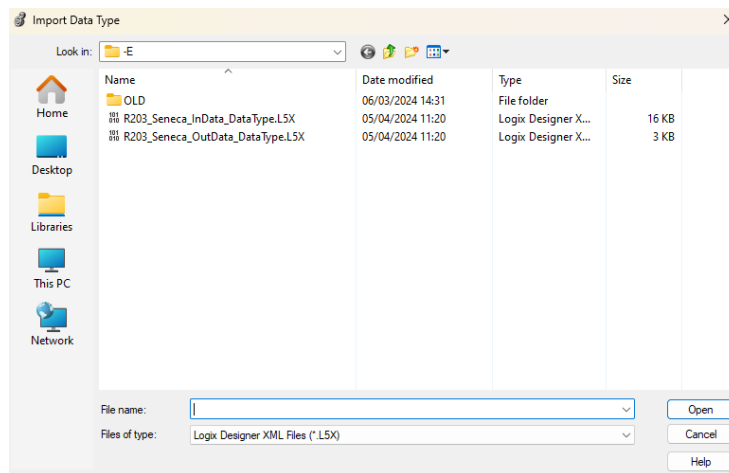

The InData will represent the measurements that come out of R203 towards the PLC, OutData are the tags that allow you to send commands to R203:

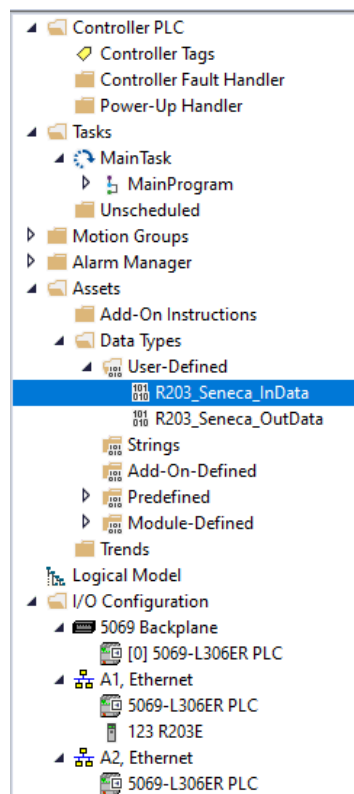

Now define the “Measurements” and “Outputs” with “R203\_Seneca\_InData” and “R203\_Seneca\_OutData” data type respectively:

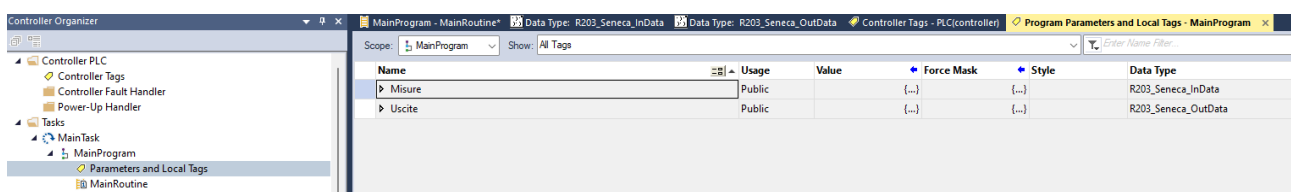

At this point define a program that copies the measurements arriving from R203 into the R203\_Seneca\_InData structure:

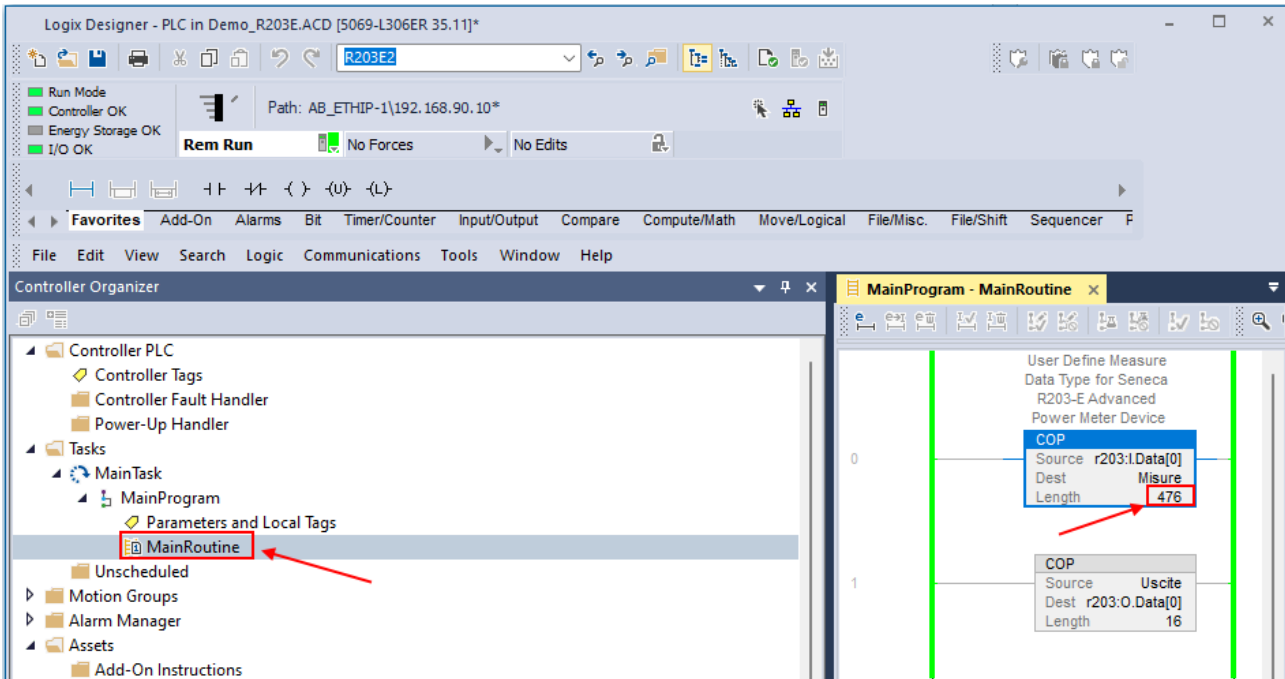

And then copy the values that you will control in the R203\_Seneca\_OutData structure into the data sent to the device:

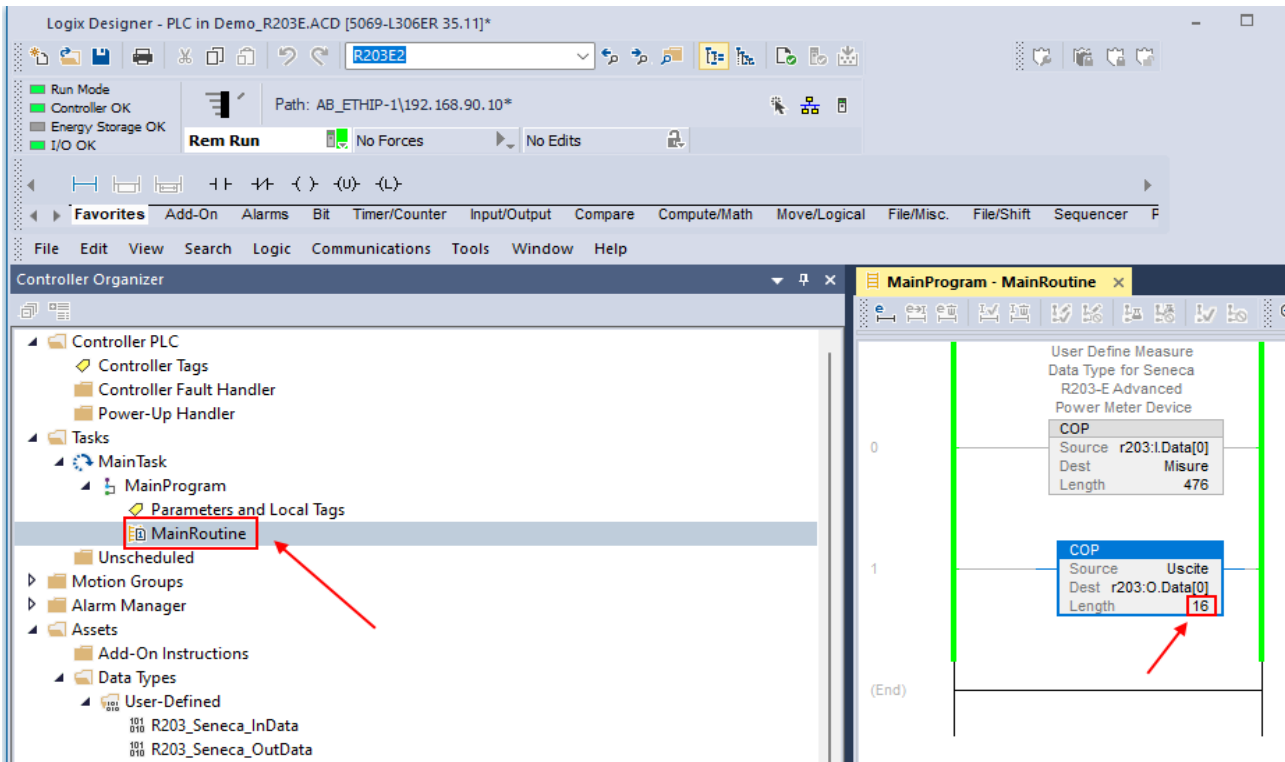

Now put the PLC in "Program" mode and download the program to the PLC.  
Put the PLC in "RUN" mode and check the measurements:

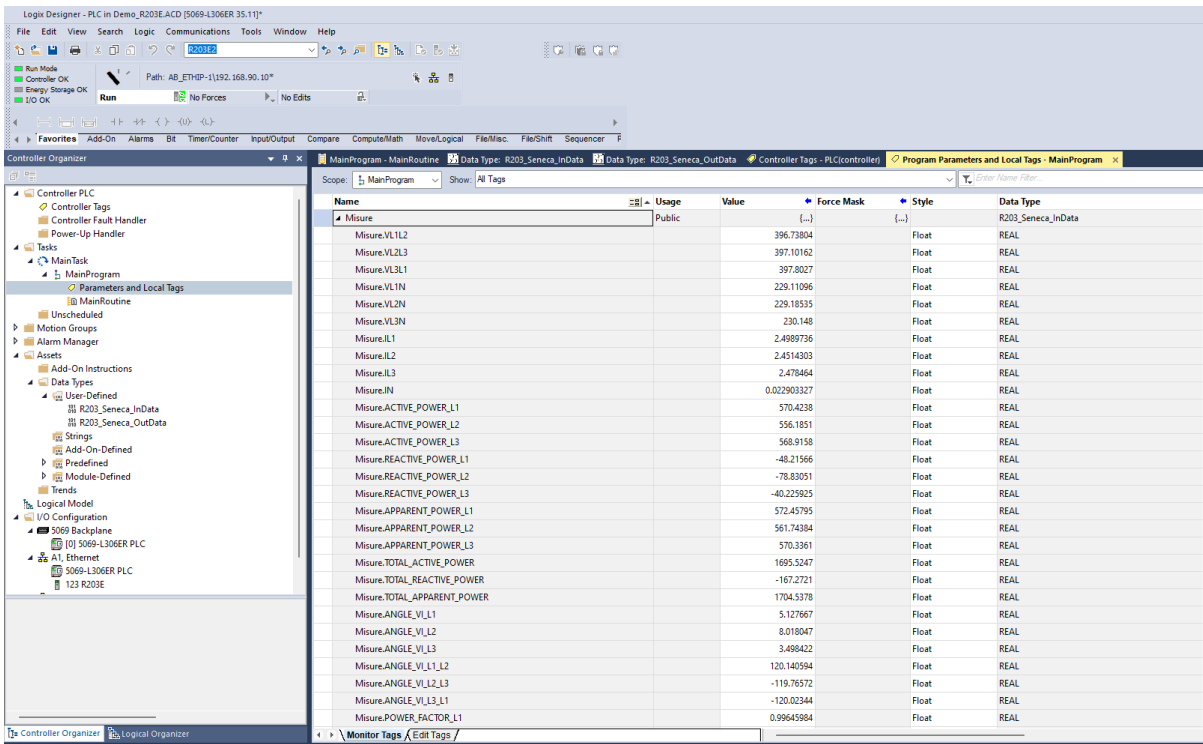

You can also control the digital outputs by activating DOUT1 for example:

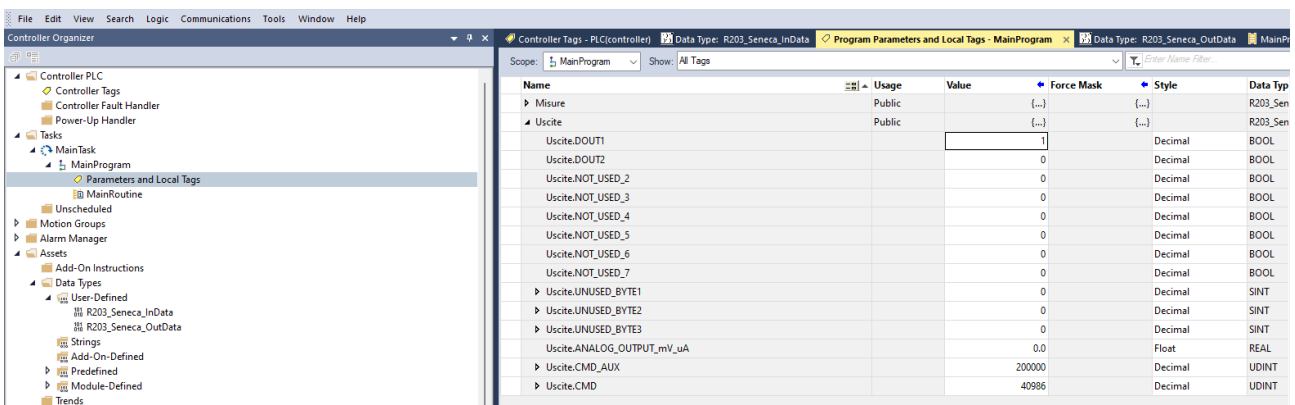

CMD and CMD AUX can be used to send commands to the device according to the following table:

COMMAND CODE(decimal)	ACTION
260	Reset MIN/MAX
259	Reset AVG
261	Reset Energy Counters
40986	Load value in CMD_AUX register to COUNTER1
41002	Load value in CMD_AUX register to COUNTER2

## 22. OPC-UA COMMUNICATION PROTOCOL (R203-U MODELS ONLY)

OPC Unified Architecture (OPC UA) is a cross-platform, open source IEC62541 standard for exchanging data from sensors to cloud and SCADA applications developed by the OPC Foundation.

### 22.1. CONFIGURATION OF THE UaEXPERT™ CLIENT FOR CONNECTION WITH R203-U

To perform a test connection, use the UaExpert™ software.

UaExpert™ is a complete OPC UA client capable of supporting different OPC UA profiles and features.

The free version can be downloaded from the link:

<https://www.unified-automation.com/downloads.html>

First, configure the OPC-UA server parameters in the webserver of the R203-U device (OPC-UA settings section):

OPC-UA SETTING		
SERVER NAME	R203	<input type="text" value="R203"/>
SERVER PORT	4840	<input type="text" value="4840"/>
AUTHENTICATION	OFF	<input type="text" value="ON"/> ▼
USERNAME	admin	<input type="text" value="admin"/>
PASSWORD	admin	<input type="text" value="admin"/>
OPC-UA SERVER SECURITY POLICY	NONE	<input type="text" value="AES128SHA256RSAOAEP"/> ▼
OPC-UA SERVER MESSAGE SECURITY MODE	SIGN AND ENCRYPT	<input type="text" value="SIGN AND ENCRYPT"/> ▼

In this way you have activated the indicated security policy.  
Use certificates by default.

Now open the OPC-UA client and press the “+” icon to add an OPC-UA server:

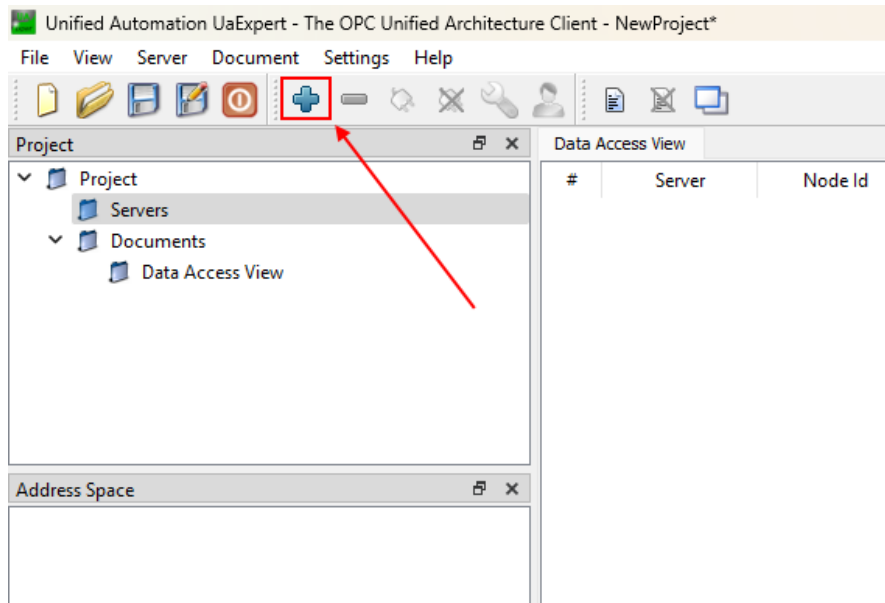

At this point under "Custom directory" we enter the IP address of the R203-U device (192.168.90.101 in the example) and the configured port (4840 in the example):

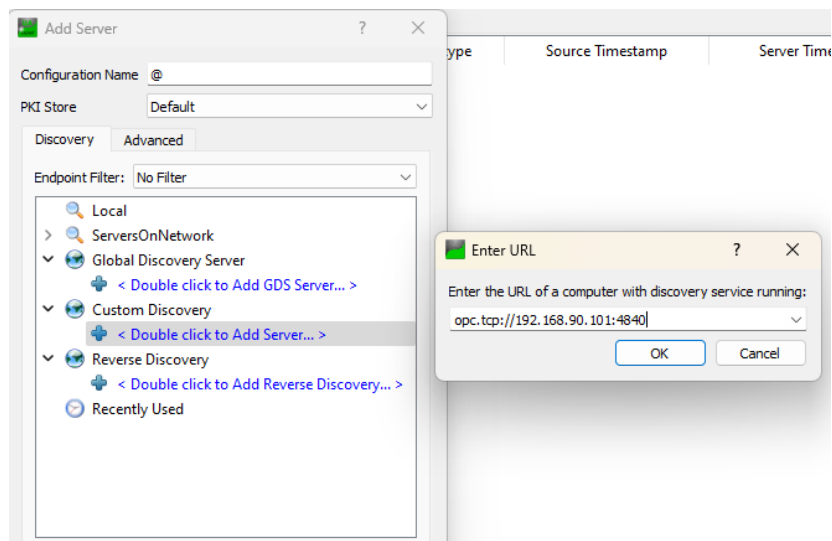



By pressing OK the server is added to the list, select the desired encryption:

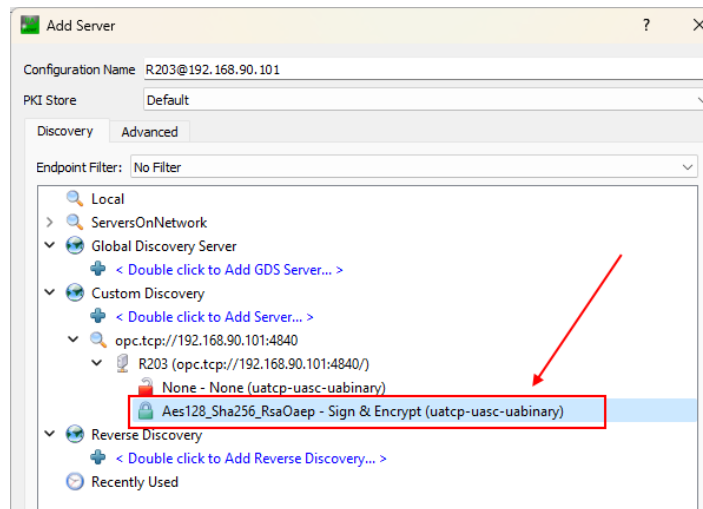

Press OK

Now the server is added.

First select the server and then press the connection icon:

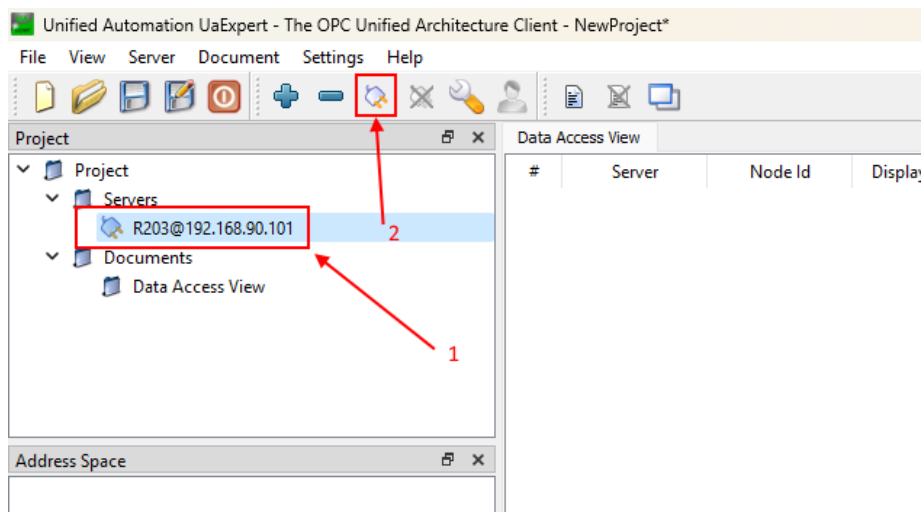

You will be asked for your credentials as configured:

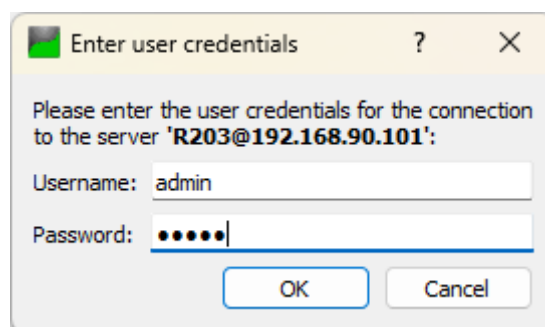

At this point a screen will appear indicating that the certificate is not secure:

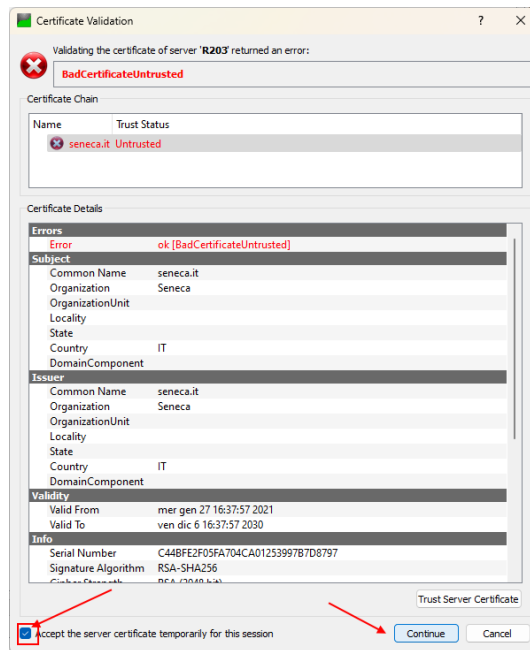

Accept the certificate and press the “Continue” button.

Now ignore the next two certificate-related errors:

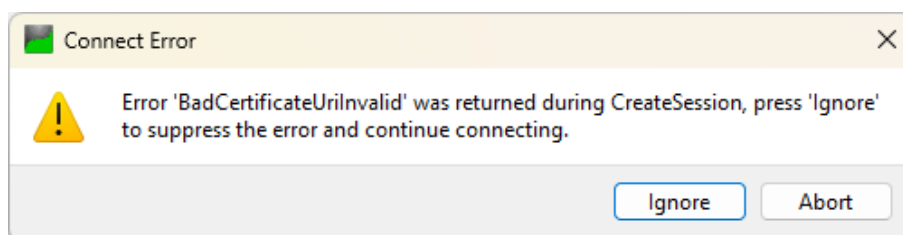
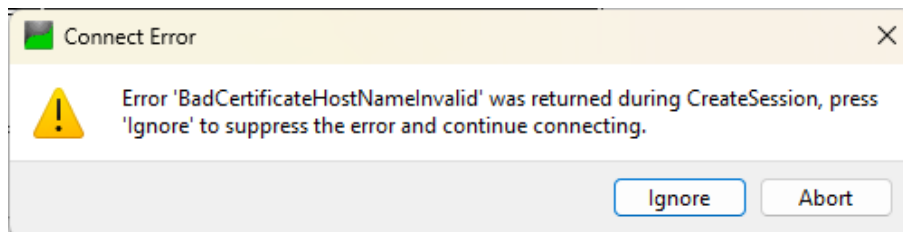

Now the connection is established and the configured list of variables appears:

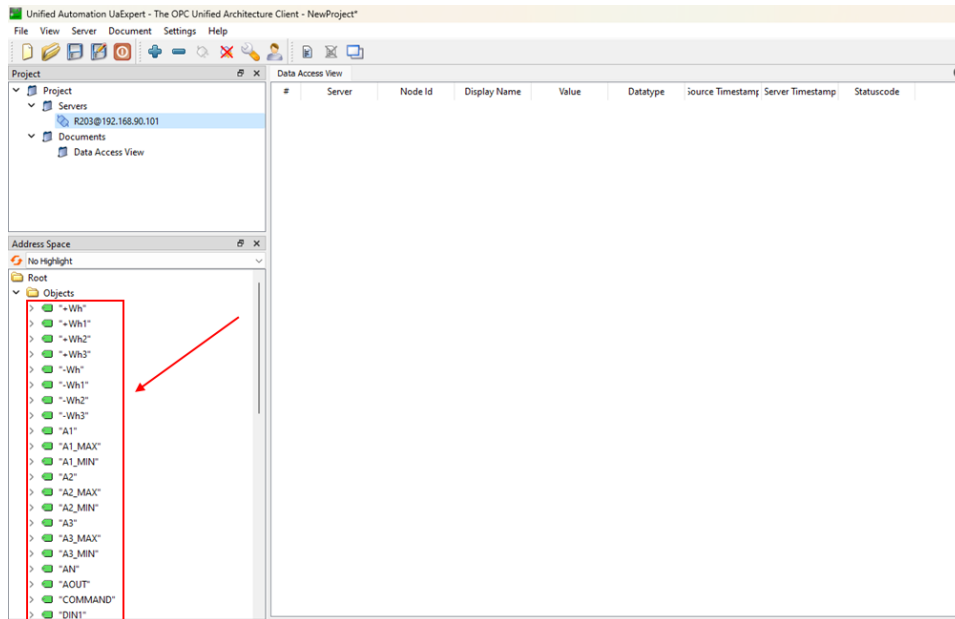

Now you can drag the variables you want to view:

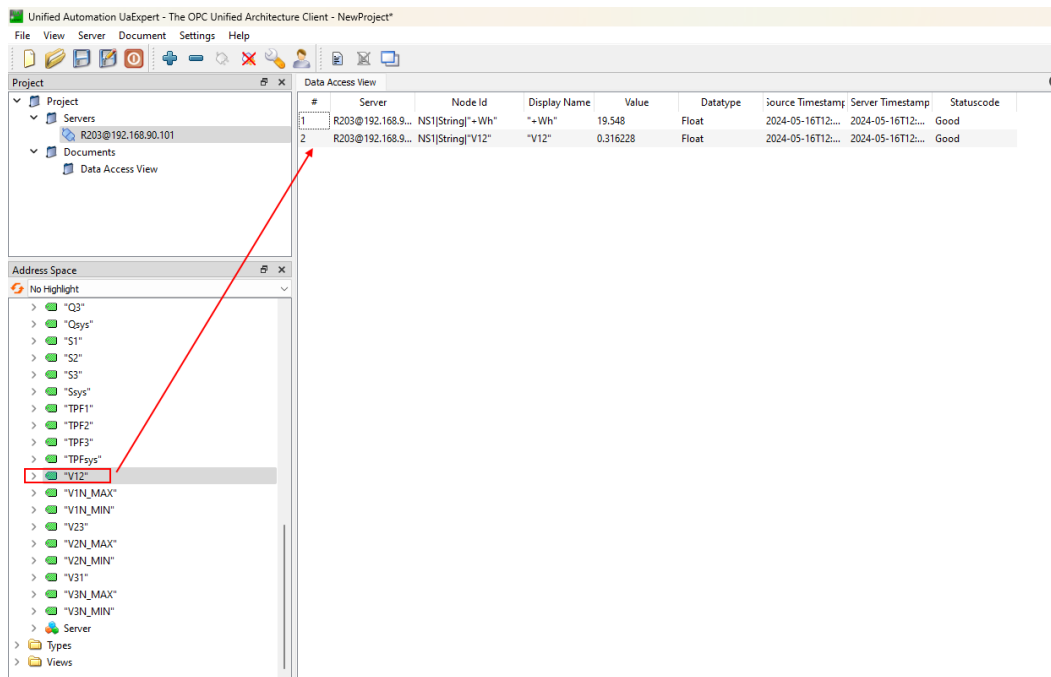

It is also possible to write on the variables in read/write mode, for example it is possible to activate the digital output DOUT2 by writing the value to 1:

Data Access View								
#	Server	Node Id	Display Name	Value	Datatype	Source Timestamp	Server Timestamp	Statuscode
1	R203@192.168.9...	NS1[String]"Wh"	"Wh"	19.548	Float	2024-05-16T12:...	2024-05-16T12:...	Good
2	R203@192.168.9...	NS1[String]"V12"	"V12"	0.316228	Float	2024-05-16T12:...	2024-05-16T12:...	Good
3	R203@192.168.9...	NS1[String]"DOUT1"	"DOUT1"	0	Byte	2024-05-16T12:...	2024-05-16T12:...	Good
4	R203@192.168.9...	NS1[String]"DOUT2"	"DOUT2"	1	Byte	2024-05-16T12:...	2024-05-16T12:...	Good