





INSTALLATION MANUAL

Z-PASS2-RT Z-PASS2-RT-S

PRELIMINARY WARNINGS

The word **WARNING** preceded by the symbol  indicates conditions or actions that put the user's safety at risk. The word **ATTENTION** preceded by the symbol  indicates conditions or actions that might damage the instrument or the connected equipment.

The warranty shall become null and void in the event of improper use or tampering with the module or devices supplied by the manufacturer as necessary for its correct operation, and if the instructions contained in this manual are not followed.

	WARNING: The full content of this manual must be read before any operation. The module must only be used by qualified electricians. Specific documentation is available using the QR-CODE shown on page 1.
	The module must be repaired and damaged parts replaced by the Manufacturer. The product is sensitive to electrostatic discharges. Take appropriate measures during any operation.
	Electrical and electronic waste disposal (applicable in the European Union and other countries with recycling). The symbol on the product or its packaging shows the product must be surrendered to a collection centre authorized to recycle electrical and electronic waste.



DOCUMENTATION
Z- PASS2-RT



DOCUMENTATION
Z- PASS2-RT-S



SENECA s.r.l.; Via Austria, 26 – 35127 – PADOVA – ITALY; Tel. +39.049.8705359 - Fax +39.049.8706287

CONTACT INFORMATION

Technical support	support@seneca.it	Product information	sales@seneca.it
-------------------	-------------------	---------------------	-----------------

This document is the property of SENECA srl. Copies and reproduction are prohibited unless authorised.
The content of this document corresponds to the described products and technologies.
Stated data may be modified or supplemented for technical and/or sales purposes.

MODULE LAYOUT

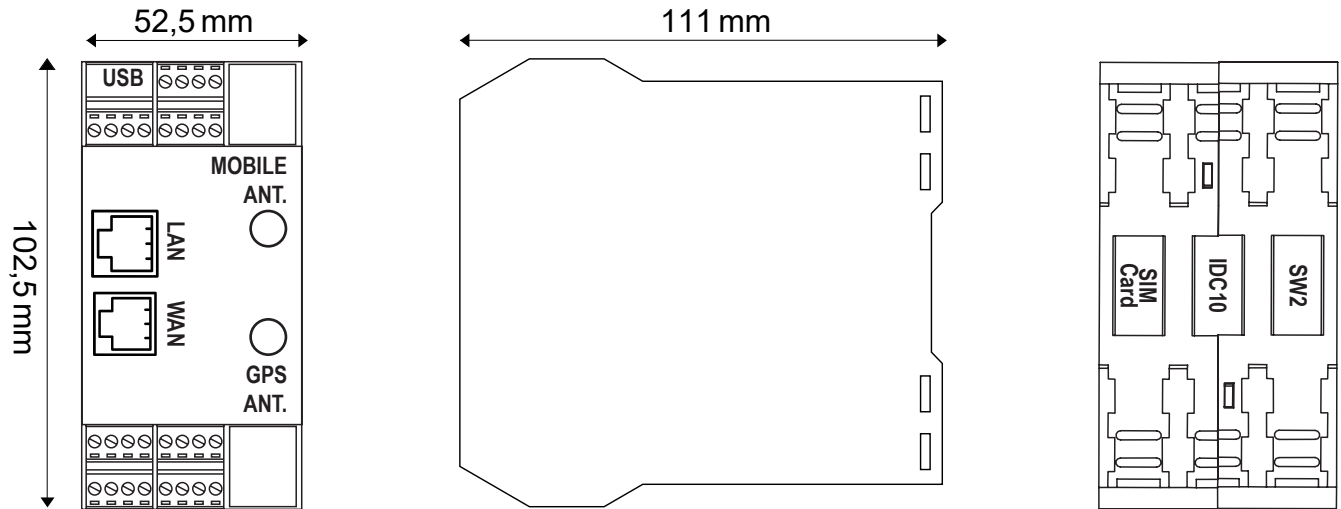



Weight: 250 g; Enclosure: PA6, Black

SIGNALS VIA LED ON FRONT PANEL

LED	STATUS	LED meaning
PWR	On	Device powered correctly
	Off	Device not powered
RUN	On	Locking system
	Flashing	The module is working correctly
	Off	System Locked / Booting
DIDO1....DIDO6	On	Input or output activated
	Off	Input or output deactivated
VPN	On	VPN connection active
	Flashing	VPN connection problems
SRV	On	VPN BOX "SERVICE" connection is working correctly
	Flashing	VPN BOX "SERVICE" connection in error
	Off	VPN BOX "SERVICE" connection disabled
RX1 / RX2 / RX4	On	Incorrect RS485/ RS232 connection
	Flashing	Reception of data packet completed on RS485/ RS232
TX1 / TX2 / TX4	Flashing	Transmission of data packet completed on RS485/ RS232
ETH ACT (Green)	Flashing	Packet transit on Ethernet port
ETH LNK (Yellow)	On	Ethernet port connected
	On	Signal level reporting
	Flashing (Only )	Modem not correctly adjusted
NET	On	Modem adjusted on 4G network
	Flashing	Modem adjusted on 2G or 3G network
	Off	Modem off or not adjusted
DATA	On	Data connection enabled and correctly adjusted
	Flashing	Data connection enabled but in error
	Off	Data connection disabled
GPS	On	GPS signal present
	Off	GPS signal absent
BAT See user manual	On	Battery connected and working properly
	Flashing	Low or faulty battery
	Off	Battery not in use (UPS not active)
PWR (MODEM)	On	Device powered correctly
	Off	Device not powered

TECHNICAL SPECIFICATIONS

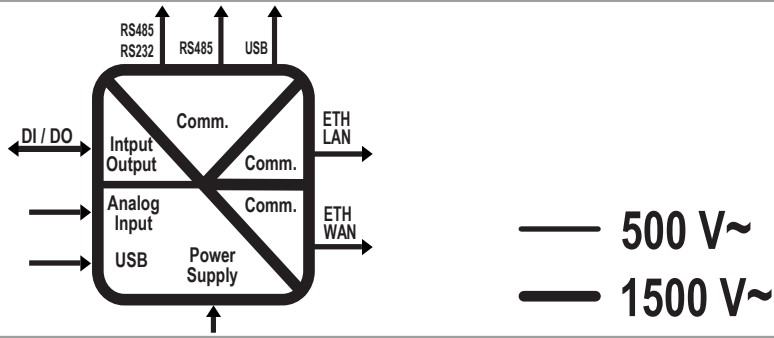
CERTIFICATIONS	  
POWER SUPPLY	11 ÷ 40Vdc; 50 ÷ 60Hz; Max absorption: 11 W
ENVIRONMENTAL CONDITIONS	Operating temperature: from -25°C to +65°C; Humidity: 10% ÷ 90% non condensing. Storage temperature: from -30°C to +80°C; Degree of protection: IP20
ASSEMBLY	35mm DIN rail IEC EN60715
CONNECTIONS	Removable 3.5 mm pitch terminal block, 1.5 mm ² max cable section
PROCESSOR	ARM 32 bit
MEMORY	512MB RAM and ≥ 4GB Flash; PUSH-PUSH type slot for micro SD
FEATURES	Integrated Web Server and update via Web Server
COMMUNICATION PORTS	COM1: RS232 / RS485 (on terminals), COM2: RS485 (on terminals or IDC10) COM4: RS485 (on terminals); maximum Baud rate 115kbps; minimum 200 bps; USB HOST type A ETH1 and ETH2 Fast Ethernet RJ45 10/100Mbps, Maximum connection distance: 100 m CAN on terminals or on IDC10 (May not be present on all models)
ISOLATION	
DIGITAL INPUTS OUTPUTS	Number of inputs: 6 max.; Number of outputs: 6 max.; Absorbed current: 3mA @ 12Vdc, 5mA @ 24Vdc. Voltage OFF<4V, ON>8V MAX. current (Vout+) 50mA Voltage (Vext+): 10 ÷ 28Vdc. MAX. current: 200 mA per channel Protect the outputs using a 1.5A fuse as shown in the wiring diagrams
ANALOGUE INPUTS	Voltage 0 ÷ 30Vdc, impedance 200kΩ Current 0 ÷ 25mA, impedance ~ 50Ω
AUXILIARY VOLTAGE OUTPUT	V AUX: 12Vdc; Max. 50 mA
4G MODEM FREQUENCIES	Global coverage Model 4G/LTE LTE-FDD: B1/B2/B3/B4/B5/B7/B8/B12/B13/B18/ B19/B20/B25/B26/B28 LTE-TDD: B38/B39/B40/ B41; WCDMA: B1/B2/B4/B5/B6/B8/B19/GSM: B2/B3/B5/B
OUTPUT POWER	GSM900: 32.75dBm, DCS1800: 29.07dBm, WCDMA: 23.13dBm, 23.27 dBm, LTE: 23.1dBm, 23.2dBm, 21.7dBm, 23.19dBm, 23.14dBm, 23.7dBm, 23.39dBm.
GNSS	GPS / GLONASS / BeiDou (compass) / Galileo / QZSS; Accuracy (Open Sky): 2.5m (CEP50).
SIM CARD SLOT	Push-push type for mini SIM card 15 X 25 mm (on instrument case back)

INSTALLATION REGULATIONS

The module has been designed for vertical installation on a DIN 46277 rail. For optimal operation and long life, adequate ventilation must be provided. Avoid positioning ducting or other objects that obstruct the ventilation slots. Avoid mounting modules over heat-generating equipment. Installation in the bottom part of the electrical panel is recommended.

⚠ ATTENTION: These are open type devices intended for installation in a final casing/panel that offers mechanical protection and protection against the spread of fire.

ModBUS CONNECTION RULES

- 1) Install the modules in the DIN rail (120 max)
 - 2) Connect the remote modules using cables of an appropriate length. The following table shows cable length data:
 - Bus length: maximum length of the Modbus network according to the Baud Rate. This is the length of the cables that connect the two farthest modules (see Diagram 1).
 - Derivation length: maximum length of a derivation 2 m.
- For maximum performance, it is recommended to use special shielded cables, designed specifically for data communication.

⚠ WARNING

This is a Class A product. In a residential environment this equipment may cause radio interference. In this case, the user may have to take adequate countermeasures.

IDC10 CONNECTOR

Power supply and Modbus interface are available also using the Seneca DIN rail bus, via the IDC10 rear connector, or the Z-PC-DINAL2-52,5 accessory.

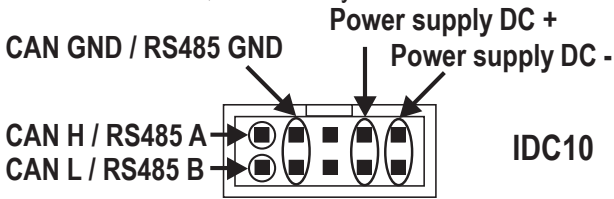

Back connector (IDC 10)

The illustration shows the meanings of the various IDC10 connector pins if signals are to be sent via them directly.

ELECTRICAL CONNECTIONS

⚠ CAUTION

Switch the module off before connecting inputs and outputs.

To meet the electromagnetic immunity requirements:

- use shielded signal cables;
- connect the shield to a preferential instrumentation earth system;
- separate shielded cables from other cables used for power installations (transformers, inverters, motors, etc...).

POWER SUPPLY	RS232 / RS485 COM1	RS485 COM2	RS485 COM4	CAN (Z-PASS2-RT-S)
<p>29 30 - 31 + 32</p>	<p>5 Tx - RS232 6 Rx - RS232 7 A - RS485 8 B - RS485 16 GND</p>	<p>13 A - RS485 14 B - RS485 15 GND 16</p>	<p>21 A - RS485 22 B - RS485 23 24 29 GND</p>	<p>21 22 23 CAN L 24 CAN H 32 GND</p>

ANALOGUE INPUTS: VOLTAGE	ANALOGUE INPUTS: CURRENT	DIGITAL INPUTS: 1 - 3
--------------------------	--------------------------	-----------------------

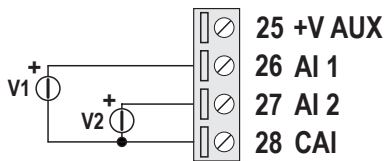

CAI: COMMON ANALOG INPUT

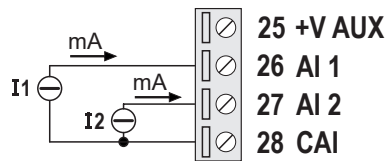

CAI: COMMON ANALOG INPUT

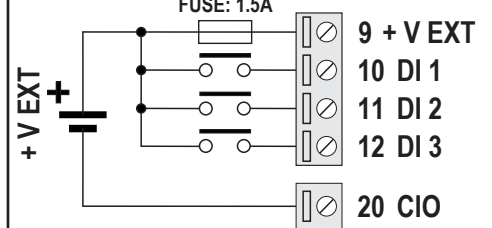

CIO: COMMON I/O

DIGITAL INPUTS: 4 - 6	DIGITAL OUTPUTS: 1 - 3	DIGITAL OUTPUTS: 4 - 6
-----------------------	------------------------	------------------------

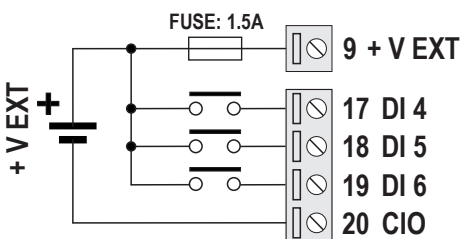

CIO: COMMON I/O

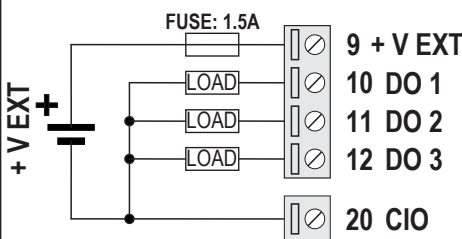

CIO: COMMON I/O

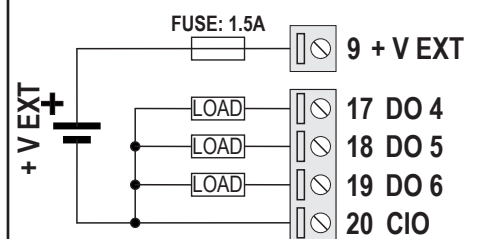

CIO: COMMON I/O

SETTING THE DIP-SWITCHES

⚠ WARNING

The DIP-switch settings are read only at boot time. At each change, perform a restart.

For use and settings via DIP-SWITCH SW1 see the user manual available on the website on the web page dedicated to the product.

SW2 DIP SWITCH SETTING: (Z- PASS2-RT-S ONLY):

Through DIP SWITCH SW2 it is possible to select RS485 or CAN communication through the IDC10 connector:

SW2		
ON		RS485 ACTIVATION
OFF		CAN ACTIVATION

KEY	
ON	
OFF	

