



INSTALLATION MANUAL

Z-SG3 ZE-SG3 ZE-SG3-P

PRELIMINARY WARNINGS

The word **WARNING** preceded by the symbol  indicates conditions or actions that put the user's safety at risk. The word **ATTENTION** preceded by the symbol  indicates conditions or actions that could damage the instrument or connected equipment.

The warranty shall become null and void in the event of improper use or tampering with the module or devices supplied by the manufacturer as necessary for its correct operation, and if the instructions contained in this manual are not followed.

	WARNING: The full content of this manual must be read before any operation. The module must only be used by qualified electricians. Specific documentation is available using the QR-CODE shown on page 1.
	The module must be repaired and damaged parts replaced by the Manufacturer. The product is sensitive to electrostatic discharges. Take appropriate measures during any operation.
	Electrical and electronic waste disposal (applicable in the European Union and other countries with recycling). The symbol on the product or its packaging shows the product must be surrendered to a collection centre authorized to recycle electrical and electronic waste.



Z-SG3
DOCUMENTATION

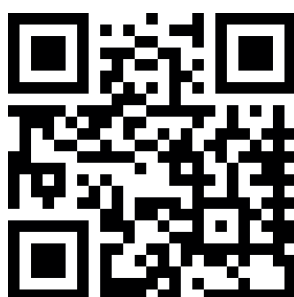

ZE-SG3
DOCUMENTATION



ZE-SG3-P
DOCUMENTATION



SENECA s.r.l.; Via Austria, 26 – 35127 – PADOVA – ITALY; Tel. +39.049.8705359 - Fax +39.049.8706287

CONTACT INFORMATION

Technical support	supporto@seneca.it	Product information	commerciale@seneca.it
-------------------	--------------------	---------------------	-----------------------

This document is the property of SENECA srl. Copies and reproduction are prohibited unless authorised.

The content of this document corresponds to the described products and technologies.

Stated data may be modified or supplemented for technical and/or sales purposes.

MODULE LAYOUT

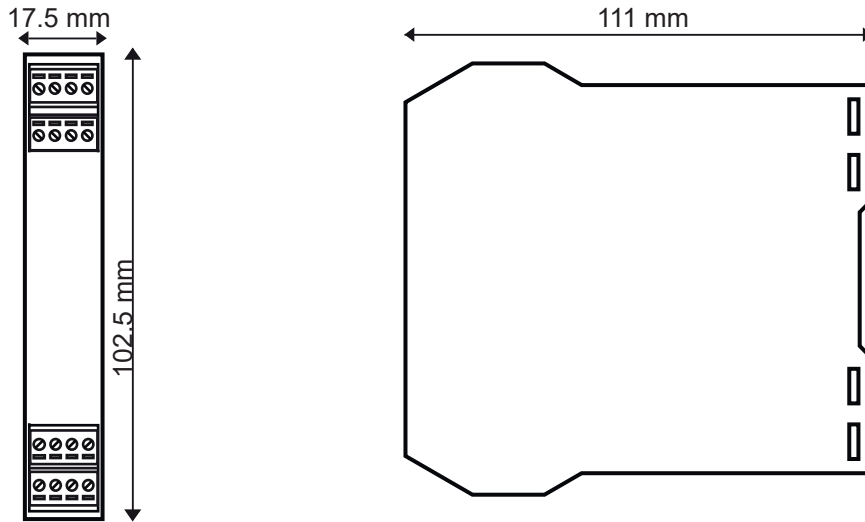



Dimensions LxHxD: 17.5 x 102.5 x 11 mm; Weight: 110 g; Enclosure: PA6, black

SIGNALS VIA LED ON FRONT PANEL

LED	STATUS	LED meaning
PWR / FAIL	ON	The device is powered correctly
	Flashing	Load cell overload
RX (ZE-SG3)	Flashing	Reception of packet completed on RS485
	ON	Anomaly / Check connection on RS485
TX (ZE-SG3)	Flashing	Transmission of packet completed on RS485
RX (Z-SG3)	Flashing	Reception of packet completed on RS485 / USB
	ON	Anomaly / Check connection on RS485
TX (Z-SG3)	Flashing	Transmission of packet completed on RS485
ETH TRF (ONLY ZE-SG3 AND ZE-SG3-P)	Flashing	Packet transmission on Ethernet port
ETH LNK (ONLY ZE-SG3 AND ZE-SG3-P)	ON	Ethernet connection present

TECHNICAL SPECIFICATIONS

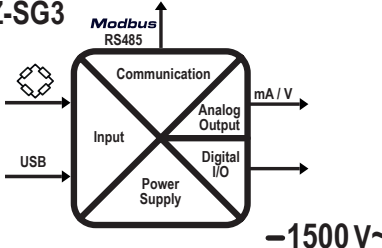
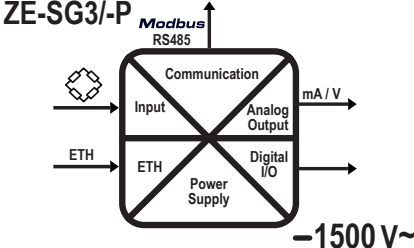





































CERTIFICATIONS	  		
INSULATION	<p>Z-SG3</p> 	<p>ZE-SG3/-P</p> 	<p>WARNING the maximum working voltage between any terminal and ground must be less than 50 Vac / 75Vdc</p>
POWER SUPPLY	Voltage: 10 ÷ 40Vdc; 19 ÷ 28Vac 50 ÷ 60Hz; Absorption: Max: 2 W		
ENVIRONMENTAL CONDITIONS	Temperature: -25 ÷ +70°C; Humidity: 30% ÷ 90% non-condensing; Storage temperature: -30 ÷ +85°; Degree of protection: IP20.		
ASSEMBLY	IEC EN60715, 35mm DIN rail in vertical position.		
CONNECTIONS	Removable 3-way screw terminals, 5 mm pitch; Rear connector IDC10 for DIN 46277 bar		
COMMUNICATION	Serial communication ports RS485 (on terminal and IDC10), 2400 - 115200 Baud front micro USB (only Z-SG3), Ethernet port 10/100 Mbit/s (only ZE-SG3 and ZE-SG3-P).		

ANALOGUE INPUT CHARACTERISTICS	Input impedance: > 1MΩ; Full scale: ± 30mV ÷ ± 460mV Error: 0.01% of the electrical full scale in “factory calibration” mode * Thermal stability: 0.0010%/C° of full scale. Cell supply voltage: 5 Vdc (supplied by the device) Resolution: ADC 24bit Response time with activated filter: 2 ÷ 850ms configurable
LOAD CELL CHARACTERISTICS	4 or 6 wires; Cell minimum impedance: 87 Ω equivalent (possibly deriving from several load cells in parallel) Cell sensitivity: From ±1 mV/V to ±64 mV/V;
ANALOGUE OUTPUT	Voltage output: Configurable between 0 ÷ 10Vdc, minimum load resistance 2kΩ Current output: Configurable between 0 ÷ 20mA, maximum load resistance: 500 Ω Retransmission error: 0.1 % of maximum field; Response time (10%...90%): 5 ms
DIGITAL IN/OUT	Opto-insulated digital input: Min. voltage: 12 V / Max. voltage: 30 V Opto-insulated digital output: Max. current: 50 mA / Max. voltage: 30 V

* In the case of “calibration with sample weight” mode, the accuracy is given by the linearity error (0.003% of the electric full scale)

SETTING THE SW1 DIP-SWITCHES (ONLY Z-SG3 AND ZE-SG3)

The position of the DIP-switches defines the Modbus communication parameters of the module: Address and Baud Rate
The following table shows the values of the Baud Rate and the address according to the setting of the DIP-switches:

DIP-Switch status				KEY										
SW1 POSITION		BAUD RATE	SW1 POSITION		ADDRESS	1	ON							
1	2		3	4		5	6	7	8					
		9600	-	-							#1	0	OFF	
		19200	-	-							#2			
		38400	#...			
		57600	-	-							#63			
		From EEPROM									From EEPROM			

Note: When DIP switches 3 to 8 are OFF, the communication settings are taken from programming (EEPROM).
DEFAULT: 384000, 8 N1

SW2 DIP-SWITCH SETTINGS

⚠ WARNING

The DIP-switch settings are read only at boot time. At each change, perform a restart.
For use and settings via DIP-SWITCH, see the user manual available on the website on the web page dedicated to the product.

PS BUTTON1

The tare is reset using the PS1 button. To reset the tare it is necessary to hold down the PS1 button for three seconds.
The update of the value will be viewable via the Webserver page and/or communication protocols.

IDC10 CONNECTOR

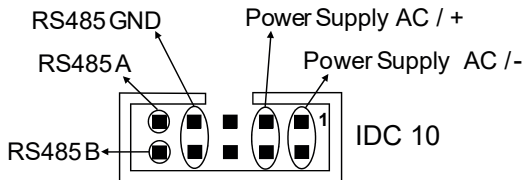

The illustration shows the meanings of the various IDC10 connector pins if signals are to be sent via them directly.

WEB SERVER (ONLY ZE-SG3 AND ZE-SG3-P)

To access the maintenance Web Server, use the following credentials:
Default user: admin; Default password: admin

⚠ CAUTION

DO NOT USE DEVICES WITH THE SAME IP ADDRESS IN THE SAME ETHERNET NETWORK.

FACTORY IP ADDRESS (ONLY ZE-SG3)

The default module IP address is static: 192. 168. 90. 101
In the ZE-SG3-P version, the module is supplied without an IP address (0.0.0).

USB PORT (ONLY Z-SG3)

The module is designed to exchange data according to the modes defined by the MODBUS protocol. It has a micro USB connector and can be configured using applications and/or software programs. The USB serial port uses the following communication parameters: **38400 BAUD, 8BIT, NO PARITY, 1 STOP BIT, ModBUS ADDRESS 1.**

The USB communication port responds exactly like the RS485 port with the exception of the communication parameters. While using the USB port, the RS485 port is disabled.

ELECTRICAL CONNECTIONS

⚠ CAUTION

The upper power supply limits must not be exceeded, as this could cause serious damage to the module.

To meet the electromagnetic immunity requirements:

- use shielded signal cables;
- connect the shield to a preferential instrumentation earth system;
- separate shielded cables from other cables used for power installations (inverters, motors, induction ovens, etc...).

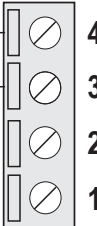
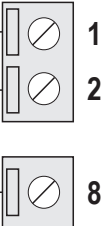
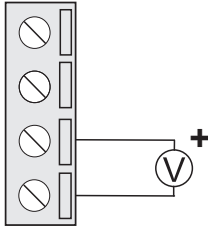
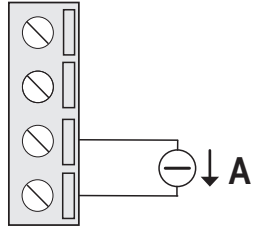
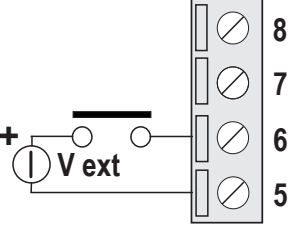
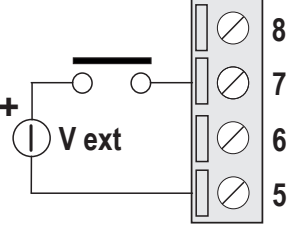
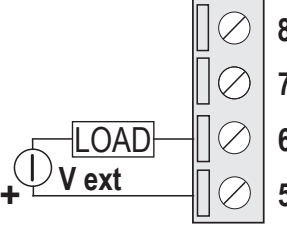
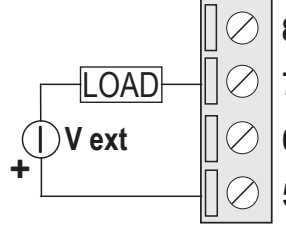
Power Supply	RS485	Analogue output (V)	Analogue output (mA)
			
Digital Input 1	Digital Input 2	Digital output 1	Digital output 2
			
Load cell	6 wires	4 wires	
<p>Connection to the load cell via 4 or 6 wires: The terminals have the following meaning: 13: Load cell positive supply 11: Load cell positive supply reading 9: Cell reading positive 12: Load cell negative supply reading 14: Load cell negative supply 10: Cell reading negative For the connections, the use of screened cables is required.</p>	