

# USER MANUAL

**SERIES R-P I/O  
WITH PROTOCOL  
PROFINET IO**



**SENECA S.r.l.**

**Via Austria 26 – 35127 – Z.I. - PADOVA (PD) - ITALY  
Tel. +39.049.8705355 – 8705355 Fax +39 049.8706287**

**[www.seneca.it](http://www.seneca.it)**



**ORIGINAL INSTRUCTIONS**

## CAUTION

SENECA does not guarantee that all specifications and/or aspects of the product and firmware, included in them, will meet the requirements of the actual final application even if the product referred to in this documentation is in compliance with the technological state of the art.

The user assumes full responsibility and/or risk with regard to the configuration of the product to achieve the intended results in relation to the specific installation and/or end application.

SENECA may, with prior agreement, provide consultancy services for the successful completion of the final application, but under no circumstances can it be held responsible for its proper functioning.

The SENECA product is an advanced product, the operation of which is specified in the technical documentation supplied with the product itself and/or can be downloaded, if desired prior to purchase, from the [www.seneca.it](http://www.seneca.it) website.

SENECA has a policy of continuous development and accordingly reserves the right to make and/or introduce - without prior notice - changes and/or improvements to any product described in this documentation.

The product described in this documentation may solely and exclusively be used by personnel qualified for the specific activity and in accordance with the relevant technical documentation, with particular attention being paid to the safety instructions.

Qualified personnel means personnel who, on the basis of their training, competence and experience, are able to identify risks and avoid potential hazards that could occur during the use of this product.

SENECA products may only be used for the applications and in the manner described in the technical documentation relating to the products themselves.

To ensure proper operation and prevent the occurrence of malfunctions, the transport, storage, installation, assembly, maintenance of SENECA products must comply with the safety instructions and environmental conditions specified in this documentation.

SENECA's liability in relation to its products is governed by the general conditions of sale, which can be downloaded from [www.seneca.it](http://www.seneca.it).

Neither SENECA nor its employees, within the limits of applicable law, will in any case be liable for any lost profits and/or sales, loss of data and/or information, higher costs incurred for goods and/or replacement services, damage to property and/or persons, interruption of activities and/or provision of services, any direct, indirect, incidental, pecuniary and non-pecuniary, consequential damages in any way caused and/or caused, due to negligence, carelessness, incompetence and/or other liabilities arising from the installation, use and/or inability to use the product.

### CONTACT US

Technical support	<a href="mailto:supporto@seneca.it">supporto@seneca.it</a>
Product information	<a href="mailto:commerciale@seneca.it">commerciale@seneca.it</a>

This document is the property of SENECA srl.  
Copies and reproduction are prohibited unless authorised.

## Document revisions

DATE	REVISION	NOTES	AUTHOR
20/02/2023	0	First revision Supported devices: R-32DIDO-1-P, R-16DI-8DO-P, R-8AI-8DIDO-P	MM
02/03/2023	1	Added chapter "Protection of digital outputs"	MM
16/03/2023	2	Added chapter on FW Update Moved chapter on configuring gsdml file parameters Added information on the procedure to restore the device to factory configuration Added I/O reaction time on R-32DIDO-P Added warning for complete hardware compilation on Tia portal	MM
31/05/2023	4	Default IP changed and Dip Switch chapter added for new firmware Deleted chapter "Restoring the device to factory configuration". Deleted chapter "CONNECTING THE DEVICE TO AN ETHERNET NETWORK" Added R-32DIDO-2-P model	MM
28/11/2023	5	Replaced model R-8AI-8DIDO-P with new hardware version	MM
05/03/2023	6	Added new info on new redesigned model of R-8AI-8DIDO-P	MM
15/03/2024	7	Updated timing for new R-32DIDO-P firmware rev 1016, chapter 2.2 updated. Updated chapter 3.2. Updated chapter 2.4 and 3.1	MM
20/03/2024	8	Added new product R-SG3-P	MM
11/07/2024	9	Added new R-4AO-8DIDO-P device	MM
11/12/2024	10	Added R-4AO-8DIDO-P "error fail" parameter info Fixed chapter 2 Added R-SG3-P PS1 button info Added info for R-SG3-P firmware >= rev 1005	MM
04/03/2025	11	Added R-4RTD-8DIDO-P Various fix	MM

**TABLE OF CONTENTS**

<b>1.</b>	<b>INTRODUCTION .....</b>	<b>6</b>
<b>2.</b>	<b>R-P SERIES DEVICES .....</b>	<b>6</b>
2.1.	INFORMATION ABOUT THE PROFINET IO PROTOCOL .....	6
2.2.	R-32DIDO-P .....	6
2.2.1.	PROTECTION OF DIGITAL OUTPUTS .....	7
2.2.2.	I/O UPDATE TIME .....	7
2.3.	R-16DI-8DO-P .....	7
2.4.	R-8AI-8DIDO-P .....	7
2.4.1.	ANALOG INPUT UPDATE TIME .....	8
2.4.2.	DIGITAL I/O UPDATE TIME .....	8
2.5.	R-SG3-P .....	8
2.5.1.	LOAD CELL CONNECTION .....	9
2.5.2.	4- OR 6-WIRE LOAD CELL CONNECTION .....	9
2.5.3.	CHECKING THE LOAD CELL OPERATION .....	9
2.5.3.1.	CHECKING CABLES WITH A DIGITAL MULTIMETER .....	9
2.5.4.	CONNECTION OF MORE LOAD CELLS IN PARALLEL .....	10
2.5.5.	TRIMMING 4-WIRE LOAD CELLS .....	11
2.5.6.	PS BUTTON1 .....	12
2.6.	R-4AO-8DIDO-P .....	12
2.6.1.	ANALOG OUTPUT RESPONSE TIME .....	12
2.6.2.	ANALOG OUTPUTS STARTING VALUE .....	12
2.6.3.	DIGITAL I/O UPDATE TIME .....	12
2.6.4.	PROTECTION OF DIGITAL OUTPUTS .....	13
2.7.	R-4RTD-8DIDO-P .....	13
2.7.1.	ANALOG INPUT UPDATE TIME .....	13
2.7.2.	UPDATE TIME OF DIGITAL INPUTS/OUTPUTS .....	13
<b>3.</b>	<b>DIP SWITCH .....</b>	<b>14</b>
3.1.	MEANING OF THE DIP SWITCHES FOR THE R-8AI-8DIDO-2-P MODEL .....	15
3.2.	MEANING OF THE DIP SWITCHES FOR THE R-32DIDO-2-P MODEL .....	15
3.3.	MEANING OF THE DIP SWITCHES FOR THE R-SG3-P MODEL .....	16
3.4.	MEANING OF THE DIP SWITCHES FOR THE R-4AO-8DIDO-P MODEL .....	17
3.5.	MEANING OF THE DIP SWITCHES FOR THE R-4RTD-8DIDO-P MODEL .....	18
<b>4.</b>	<b>WEB SERVER .....</b>	<b>19</b>
4.1.	ACCESS TO THE WEB SERVER .....	19
<b>5.</b>	<b>EXAMPLE OF CREATING A PROJECT WITH SIEMENS PLC (TIA PORTAL 16) .....</b>	<b>21</b>
5.1.	INSTALLING THE GSDML FILE .....	22
5.2.	INSERTION OF THE SIEMENS PLC IN THE PROJECT .....	23
5.3.	INSERTION OF THE PROFINET SENECA IO .....	26
5.4.	CONFIGURATION OF THE PARAMETERS OF THE SENECA DEVICE .....	29
5.5.	CONFIGURATION PARAMETERS OF THE GSDML FILE .....	30
5.5.1.	R-32DIDO-P .....	30

5.5.2.	R-16DI-8DO-P .....	30
5.5.3.	R-8AI-8DIDO-P .....	31
5.5.4.	R-SG3-P .....	33
5.5.5.	R-4AO-8DIDO-P .....	40
5.5.6.	R-4RTD-8DIDO-P .....	42
5.6.	R-32DIDO-P I/O DATA .....	44
5.7.	R-16DI-8DO-P I/O DATA .....	47
5.8.	R-8AI-8DIDO-P I/O DATA .....	52
5.9.	R-SG3-P I/O DATA .....	53
5.10.	R- 4AO-8DIDO-P I/O DATA .....	63
5.11.	I/O R-4RTD-8DIDO-P DATA .....	65
5.12.	COMPILATION AND SENDING OF THE PROJECT TO THE SIEMENS PLC .....	68
<b>6.</b>	<b>EXAMPLE OF CREATING A PROJECT WITH PLC CODESYS 3.5 .....</b>	<b>70</b>
6.1.1.	INSERTION OF THE CODESYS PLC IN THE PROJECT .....	70
6.1.2.	INSTALLING THE GSD .....	73
6.1.3.	INSTALLATION OF THE SENECA PROFINET IO .....	75
6.1.4.	CONFIGURATION OF THE PARAMETERS OF THE SENECA IO .....	76
6.1.5.	READING AND WRITING THE SENECA IO FROM CODESYS .....	78
<b>7.</b>	<b>CABLE HARNESS FOR MODELS WITH DOUBLE ETHERNET PORT .....</b>	<b>80</b>
7.1.	CHAIN ETHERNET CONNECTION (DAISY CHAIN) .....	80
7.2.	LAN FAULT-BYPASS FUNCTION .....	82
<b>8.</b>	<b>SEARCH AND MODIFICATION OF THE DEVICE IP WITH SENECA DISCOVERY TOOL .....</b>	<b>83</b>
<b>9.</b>	<b>FIRMWARE UPDATE .....</b>	<b>85</b>

## 1. INTRODUCTION



### ATTENTION!

This user manual extends the information from the installation manual to the configuration of the device. Use the installation manual for more information.



### ATTENTION!

In any case, SENECA s.r.l. or its suppliers will not be responsible for the loss of data/revenue or consequential or incidental damages due to negligence or bad/improper management of the device, even if SENECA is well aware of these possible damages.

SENECA, its subsidiaries, affiliates, group companies, suppliers and distributors do not guarantee that the functions fully meet the customer's expectations or that the device, firmware and software should have no errors or operate continuously.

## 2. R-P SERIES DEVICES

The R series I/O devices support the Profinet IO protocol

### 2.1. INFORMATION ABOUT THE PROFINET IO PROTOCOL

Type of protocol: Class A Device, Cyclic Real-time (RT) and Acyclic Data

The device has been tested using the following PLCs:  
SIEMENS S7 1200 firmware revision 4.3 (Tia Portal 16)  
CODESYS Runtime 3.5 (Codesys 3.5)

### 2.2. R-32DIDO-P

The device allows the use of 32 digital channels that can be individually configured for input or output.

<b>CODE</b>	<b>ETHERNET PORTS</b>
R-32DIDO-2-P	2 10/100 Mbit PORTS (Switch mode)

### 2.2.1. PROTECTION OF DIGITAL OUTPUTS

The outputs are protected against overload and against overtemperature, they open cyclically until the fault is repaired or the output opens.

The limit current is between 0.6 and 1.2 A.

### 2.2.2. I/O UPDATE TIME

The update of the 32 digital I/Os is performed every 2ms.

### 2.3. R-16DI-8DO-P

The devices allow the use of 16 digital input channels and 8 digital output channels (relay).

<b>CODE</b>	<b>ETHERNET PORTS</b>
R-16DI8DO-P	2 10/100 Mbit PORTS (Switch mode)

### 2.4. R-8AI-8DIDO-P

The devices allow the use of 8 analog input channels and 8 digital channels that can be individually configured for input or output.

<b>CODE</b>	<b>ETHERNET PORTS</b>
R-8AI-8DIDO-2-P	2 10/100 Mbit PORTS (Switch mode)

### 2.4.1. ANALOG INPUT UPDATE TIME

Sampling time can be configured from 4ms to 400ms per each channel.

By activating 8 channels and setting a sampling time of 4 ms, you get an input update every:  $4 \times 8 = 32$  ms.

**Note (only if thermocouple channels are enabled):**

In the case of a thermocouple input, the Burnout check is carried out every 10 seconds.

The duration of this check takes a sampling on each enabled thermocouple channel.

For example, with 3 active thermocouples, every 10 seconds the following are used:

$4\text{ms} \times 3 \text{ channels} = 12 \text{ ms}$  for Burnout evaluation.



## ATTENTION!

**IF ANALOG INPUT 1 IS CONFIGURED IN RTD PT100 MODE, THE MINIMUM SAMPLING TIME FOR THIS CHANNEL TO OBTAIN A CORRECT MEASUREMENT IS 25 ms**

### 2.4.2. DIGITAL I/O UPDATE TIME

The update time of the 8 digital I/Os is 4ms.

### 2.5. R-SG3-P

The device allows the use of an analogue channel for strain gauge load cells and 2 digital channels that can be individually configured for input or output.

<b>CODE</b>	<b>ETHERNET PORTS</b>
R-SG3-P	1 10/100 Mbit PORT (Switch mode)

The measurement, carried out with the 4 or 6 wire technique.

The device is equipped with a new noise filter specifically developed to obtain a rapid response time.



### 2.5.1. LOAD CELL CONNECTION

It is possible to connect the converter to the load cell in 4- or 6-wire mode. 6-wire measurement is preferable for measurement accuracy.

The load cell power supply is provided directly by the device.

### 2.5.2. 4- OR 6-WIRE LOAD CELL CONNECTION

A load cell can have a four-wire or six-wire cable. In addition to having the +/- excitation and +/- signal lines a six-wire cable also has the +/- sense lines. It is a common misconception to think that the only difference between 4- or 6-wire load cells is the possibility of the latter to measure the actual voltage at the load cell. A load cell is compensated to work within specifications in a certain temperature range (usually -10 - +40°C). Since the cable resistance depends on the temperature, the response of the cable to temperature changes must be eliminated. The 4-wire cable is part of the load cell temperature compensation system. The 4-wire load cell is calibrated and compensated with a certain amount of cable connected. For this reason, never cut the cable of a 4-wire load cell. The cable of a 6-wire cell, on the other hand, is not part of the load cell temperature compensation system. The sense lines are connected to the R-SG3 sense terminals, to measure and adjust the actual voltage of the load cell. The advantage of using this "active" system is the possibility of cutting (or extending) the 6-wire load cell cable to any length. It must be considered that a 6-wire load cell will not reach the performance declared in the specifications if the sense lines are not used.

### 2.5.3. CHECKING THE LOAD CELL OPERATION

Before starting the configuration of the device it is necessary to verify the correctness of the wiring and the integrity of the load cell.

#### 2.5.3.1. CHECKING CABLES WITH A DIGITAL MULTIMETER

First you need to check with the load cell manual that there are about 5V DC between the +Excitation and – Excitation cables. If the cell has 6 wires check that the same voltage is also measured between +Sense and – Sense.

Now leave the cell at rest (without the tare) and check that the voltage between the +Signal and –Signal cables is around 0 V.

Now unbalance the cell by applying a compression force, checking that the voltage between the +Signal and – Signal cables increases until it reaches the full scale (if possible) where the measurement will be approximately:

5\* (cell sensitivity) mV.

For example, if the declared cell sensitivity is 2 mV/V,  $5 * 2 = 10$  mV must be obtained.

In the case of bipolar measurement only (compression/traction) it is necessary to completely unbalance the cell even in traction, in this case the same value must be measured between the +Signal and –Signal cables but with the negative sign:

$-5 \cdot (\text{cell sensitivity}) \text{ mV}$ .

### 2.5.4. CONNECTION OF MORE LOAD CELLS IN PARALLEL

It is possible to connect up to a maximum of 8 load cells (and in any case without ever falling below the minimum 87 Ohms).

It is therefore possible to connect:

NUMBER OF LOAD CELLS IN PARALLEL	
IMPEDANCE OF THE STATED LOAD CELL [Ohm]	MAXIMUM NUMBER OF CONNECTABLE CELLS IN PARALLEL
350	4
1000	8

For the connection of 4 load cells Seneca recommends using the SG-EQ4 product.

To connect 2 or more 4-wire cells in parallel with the SG-EQ4 junction box, use the following diagram:

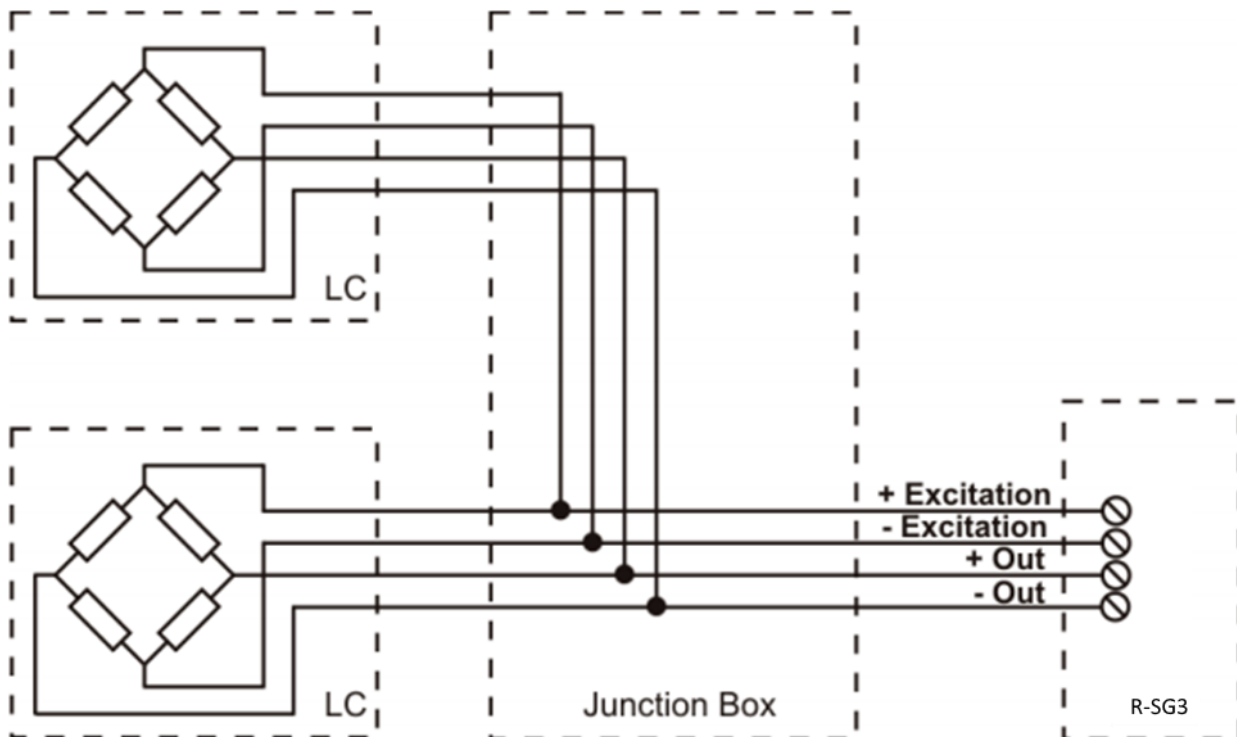

To connect 2 or more 6-wire cells in parallel with the SG-EQ4 junction box use the following diagram:

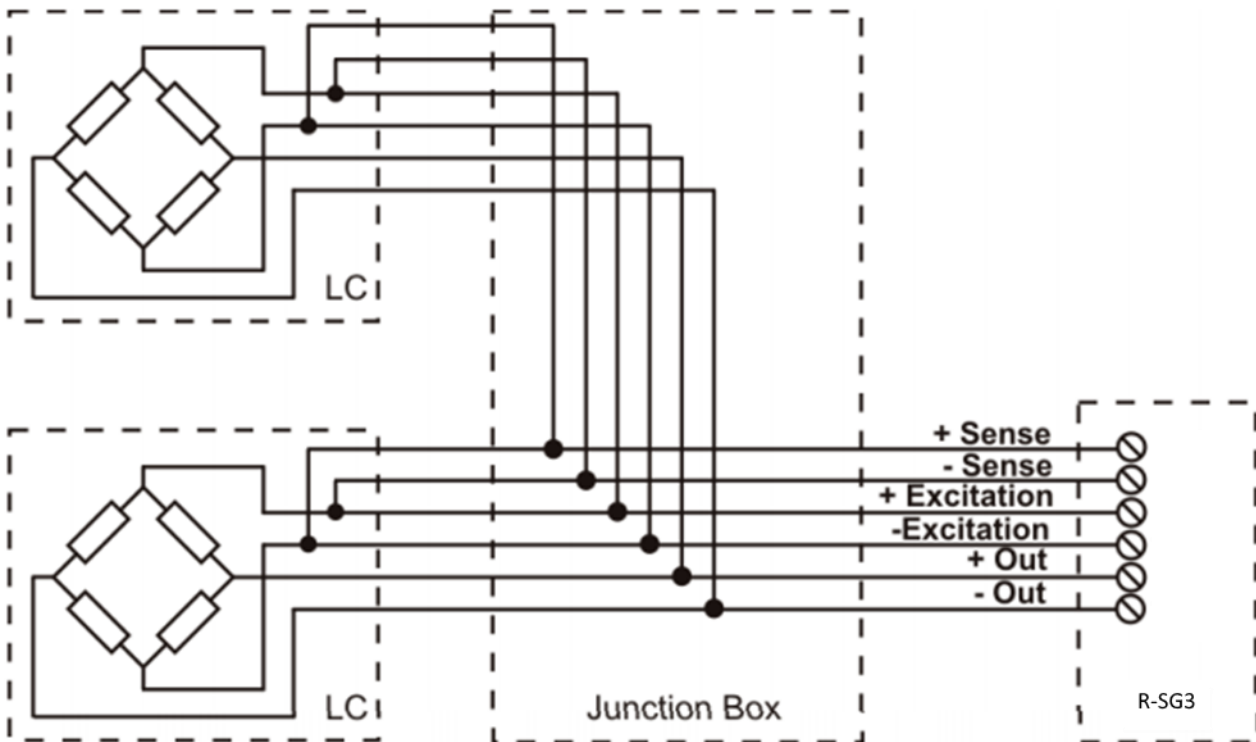

For more details, refer to the SG-EQ4 Junction Box accessory manual.

### 2.5.5. TRIMMING 4-WIRE LOAD CELLS

The figure below shows a diagram of three trimmed load cells.

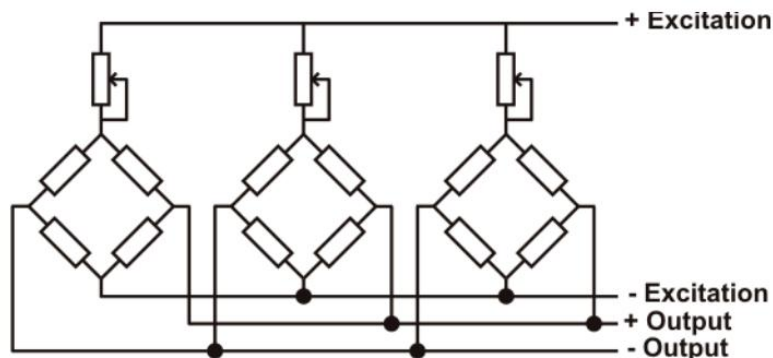

A variable resistor, independent of the temperature, or a typically 20 Ω potentiometer is inserted in the +Excitation cable of each load cell. There are two ways to trim the load cells. The first method is to adjust the potentiometers by trial, shifting the calibration weights from one corner to another.

All the potentiometers must be adjusted so as to set the maximum sensitivity for each cell, turning them all completely clockwise. Then, once the angle with the lowest output is located, act on the trimmers of the other cells until obtaining the same minimum output value. This method can be very long, especially for large scales where the use of test weights on the corners is not very practical. In these cases the second, more suitable method is to "pre-trim" the potentiometers using a precision voltmeter (at least 4 1/2 digits). You can use the following procedure:

- 1) Determine the exact mV/V ratio of each load cell, shown in the calibration certificate of the cell itself.
- 2) Determine the exact excitation voltage provided by the indicator/meter (for example Z-SG), measuring this voltage with the voltmeter (for example 10.05 V).
- 3) Multiply the lowest mV/V value found (point 1) by the excitation voltage (point 2).
- 4) Divide the trimming factor calculated in point 3 by the mV/V value of the other load cells.
- 5) Measure and adjust the excitation voltage of the other three load cells using the respective potentiometer. Check the results and make a final adjustment by moving a test load from corner to corner.

### 2.5.6. PS BUTTON1

The PS1 button is positioned next to the SW2 dip switch. If pressed for a few seconds it allows you to acquire the Tare (the same function is possible from the command register and digital input).

## 2.6. R-4AO-8DIDO-P

The device provides 4 analog output analog channels (that can be individually configured in Voltage or Current) and 8 digital channels that can be individually configured for input or output.

<b>CODE</b>	<b>ETHERNET PORT</b>
R-4AO-8DIDO	2 PORTS 10/100 Mbit (Switch mode)

### 2.6.1. ANALOG OUTPUT RESPONSE TIME

The analog output response time to go from 10% to 90% of the full scale is 5ms.

### 2.6.2. ANALOG OUTPUTS STARTING VALUE

At startup analog outputs assume the value set in the "fail value" parameter.

### 2.6.3. DIGITAL I/O UPDATE TIME

The update time of the 8 digital I/Os is 2ms.

#### 2.6.4. PROTECTION OF DIGITAL OUTPUTS

The outputs are protected against overload and against overtemperature, they open cyclically until the fault is repaired or the output opens.

The limit current is between 0.6 and 1.2 A.

#### 2.7. R-4RTD-8DIDO-P

The devices allow the use of 4 thermoresistance measurement channels and 8 digital channels that can be individually configured for input or output.

<b>CODE</b>	<b>ETHERNET PORT</b>
R-4RTD-8DIDO-P	2 PORTS 10/100 Mbit (Switch mode)

##### 2.7.1. ANALOG INPUT UPDATE TIME

Sampling time is configurable from 25ms to 400ms, in particular:

<b>CHANNEL UPDATE TIME</b>
25ms
50ms
100ms
200ms
400ms

Since each channel has an independent analog/digital converter, this set time coincides with the refresh time of each channel.

Therefore, by activating all 4 channels and setting a sampling time of 25 ms, you get an input update every 25 ms.

##### 2.7.2. UPDATE TIME OF DIGITAL INPUTS/OUTPUTS

The update time of all 8 digital inputs/outputs is 2ms.

### 3. DIP SWITCH

 **ATTENTION!**

TO INCREASE THE DEVICE'S SECURITY FROM EXTERNAL ATTACKS, IT IS RECOMMENDED TO DISABLE ACCESS TO THE WEBSERVER THROUGH THE DIP SWITCHES

 **ATTENTION!**

THE DIP SWITCH SETTINGS ARE READ ONLY AT THE START. AT EACH CHANGE, IT IS NECESSARY TO RESTART.

**3.1. MEANING OF THE DIP SWITCHES FOR THE R-8AI-8DIDO-2-P MODEL**

** ATTENTION!**

**FROM THE 1010 FIRMWARE REVISION THE DEVICES ARE SUPPLIED WITHOUT AN IP ADDRESS (0.0.0.0).**

**MORE DEVICES CAN THEREFORE BE INSERTED INTO THE SAME PROFINET NETWORK AND IDENTIFIED THROUGH SCAN OF THE PROFINET NETWORK ITSELF**

**TO SET AN IP ADDRESS (FOR EXAMPLE TO ACCESS THE WEBSERVER OR TO CONNECT TO THE SENECA DISCOVERY DEVICE TOOL) USE THE PROFINET CONFIGURATION ENVIRONMENT OR FORCE THE ADDRESS 192.168.90.101 WITH THE APPROPRIATE DIP SWITCH**

<i>DIP1</i>	<i>DIP2</i>	<i>MEANING</i>
OFF	OFF	Normal operation: The device loads the configuration from the flash.
ON	ON	Resets the device to its factory configuration: (With IP address 0.0.0.0) In this case the STS LED will start flashing to indicate that the device does not have a configured IP address.
OFF	ON	Disables access to the Web server
ON	OFF	Forces the device IP address to the standard value of SENECA Ethernet products: 192.168.90.101

**3.2. MEANING OF THE DIP SWITCHES FOR THE R-32DIDO-2-P MODEL**

Below is the meaning of the SW1 dip switches:

** ATTENTION!**

**FROM THE 1010 FIRMWARE REVISION THE DEVICES ARE SUPPLIED WITHOUT AN IP ADDRESS (0.0.0.0).**

**MORE DEVICES CAN THEREFORE BE INSERTED INTO THE SAME PROFINET NETWORK AND IDENTIFIED THROUGH SCAN OF THE PROFINET NETWORK ITSELF**

**TO SET AN IP ADDRESS (FOR EXAMPLE TO ACCESS THE WEBSERVER OR TO CONNECT TO THE SENECA DISCOVERY DEVICE TOOL) USE THE PROFINET CONFIGURATION ENVIRONMENT OR FORCE THE ADDRESS 192.168.90.101 WITH THE APPROPRIATE DIP SWITCH**

<i>DIP1</i>	<i>DIP2</i>	<i>MEANING</i>
OFF	OFF	Normal operation: The device loads the configuration from the flash.
ON	ON	Resets the device to its factory configuration: (With IP address 0.0.0.0) In this case the STS LED will start flashing to indicate that the device does not have a configured IP address.
OFF	ON	Disables access to the Web server
ON	OFF	Forces the device IP address to the standard value of SENECA Ethernet products: 192.168.90.101

### 3.3. MEANING OF THE DIP SWITCHES FOR THE R-SG3-P MODEL

Below is the meaning of the SW1 dip switches:

 **ATTENTION!**

**THE DEVICES ARE SUPPLIED WITHOUT AN IP ADDRESS (0.0.0.0).**

**MORE DEVICES CAN THEREFORE BE INSERTED INTO THE SAME PROFINET NETWORK AND IDENTIFIED THROUGH SCAN OF THE PROFINET NETWORK ITSELF**

**TO SET AN IP ADDRESS (FOR EXAMPLE TO ACCESS THE WEBSERVER OR TO CONNECT TO THE SENECA DISCOVERY DEVICE TOOL) USE THE PROFINET CONFIGURATION ENVIRONMENT OR FORCE THE ADDRESS 192.168.90.101 WITH THE APPROPRIATE DIP SWITCH**

<i>DIP1</i>	<i>DIP2</i>	<i>MEANING</i>
OFF	OFF	Normal operation: The device loads the configuration from the flash.
ON	ON	Resets the device to its factory configuration: (With IP address 0.0.0.0) In this case the STS LED will start flashing to indicate that the device does not have a configured IP address.
OFF	ON	Disables access to the Web server
ON	OFF	Forces the device IP address to the standard value of SENECA Ethernet products: 192.168.90.101



### 3.4. MEANING OF THE DIP SWITCHES FOR THE R-4AO-8DIDO-P MODEL

Below is the meaning of the SW1 dip switches:

** ATTENTION!**

**THE DEVICES ARE SUPPLIED WITHOUT AN IP ADDRESS (0.0.0.0).**

**MORE DEVICES CAN THEREFORE BE INSERTED INTO THE SAME PROFINET NETWORK AND IDENTIFIED THROUGH SCAN OF THE PROFINET NETWORK ITSELF**

**TO SET AN IP ADDRESS (FOR EXAMPLE TO ACCESS THE WEBSERVER OR TO CONNECT TO THE SENECA DISCOVERY DEVICE TOOL) USE THE PROFINET CONFIGURATION ENVIRONMENT OR FORCE THE ADDRESS 192.168.90.101 WITH THE APPROPRIATE DIP SWITCH**

<i>DIP1</i>	<i>DIP2</i>	<i>MEANING</i>
OFF	OFF	Normal operation: The device loads the configuration from the flash.
ON	ON	Resets the device to its factory configuration: (With IP address 0.0.0.0) In this case the STS LED will start flashing to indicate that the device does not have a configured IP address.
OFF	ON	Disables access to the Web server
ON	OFF	Forces the device IP address to the standard value of SENECA Ethernet products: 192.168.90.101

### 3.5. MEANING OF THE DIP SWITCHES FOR THE R-4RTD-8DIDO-P MODEL

Below is the meaning of the SW1 dip switches:

** ATTENTION!**

**THE DEVICES ARE SUPPLIED WITHOUT AN IP ADDRESS (0.0.0.0).**

**MORE DEVICES CAN THEREFORE BE INSERTED INTO THE SAME PROFINET NETWORK AND IDENTIFIED THROUGH SCAN OF THE PROFINET NETWORK ITSELF**

**TO SET AN IP ADDRESS (FOR EXAMPLE TO ACCESS THE WEBSERVER OR TO CONNECT TO THE SENECA DISCOVERY DEVICE TOOL) USE THE PROFINET CONFIGURATION ENVIRONMENT OR FORCE THE ADDRESS 192.168.90.101 WITH THE APPROPRIATE DIP SWITCH**

<i>DIP1</i>	<i>DIP2</i>	<i>MEANING</i>
OFF	OFF	Normal operation: The device loads the configuration from the flash.
ON	ON	Resets the device to its factory configuration: (With IP address 0.0.0.0) In this case the STS LED will start flashing to indicate that the device does not have a configured IP address.
OFF	ON	Disables access to the Web server
ON	OFF	Forces the device IP address to the standard value of SENECA Ethernet products: 192.168.90.101

## 4. WEB SERVER

 **ATTENTION!**

BEFORE ACCESSING THE WEB SERVER, DISCONNECT THE DEVICE FROM THE PROFINET NETWORK

 **ATTENTION!**

SOME MODELS ARE SUPPLIED WITHOUT AN IP ADDRESS (0.0.0.0) IN THIS CASE THE “STS” LED FLASHES.

TO SET AN IP ADDRESS (FOR EXAMPLE TO ACCESS THE WEBSERVER OR TO CONNECT TO THE SENECA DISCOVERY DEVICE TOOL) USE THE PROFINET CONFIGURATION ENVIRONMENT OR FORCE THE ADDRESS 192.168.90.101 WITH THE APPROPRIATE DIP SWITCH

The main purpose of the web server is to:

- Configure the Profinet name of the device without using an external development environment (Tia Portal, Codesys...)
- Allow the device firmware update

### 4.1. ACCESS TO THE WEB SERVER

Access to the web server takes place using a web browser and entering the IP address of the device.

On first access the user name and password will be requested.

The default values are:

User Name: admin

Password: admin

 **ATTENTION!**

DEPENDING ON THE DEVICE MODEL AND THE FIRMWARE INSTALLED IN THE DEVICE, IT MAY BE NECESSARY TO ACTIVATE THE DIP SWITCHES TO USE THE WEBSERVER

 **ATTENTION!**

AS LONG AS THE STS LED IS FLASHING IT MEANS THE DEVICE HAS NOT SET AN IP ADDRESS. IN THIS SITUATION IT WILL NOT BE POSSIBLE TO ACCESS THE WEBSERVER

 **ATTENTION!**

AFTER THE FIRST ACCESS CHANGE USER NAME AND PASSWORD IN ORDER TO PREVENT ACCESS TO THE DEVICE TO UNAUTHORIZED PEOPLE.

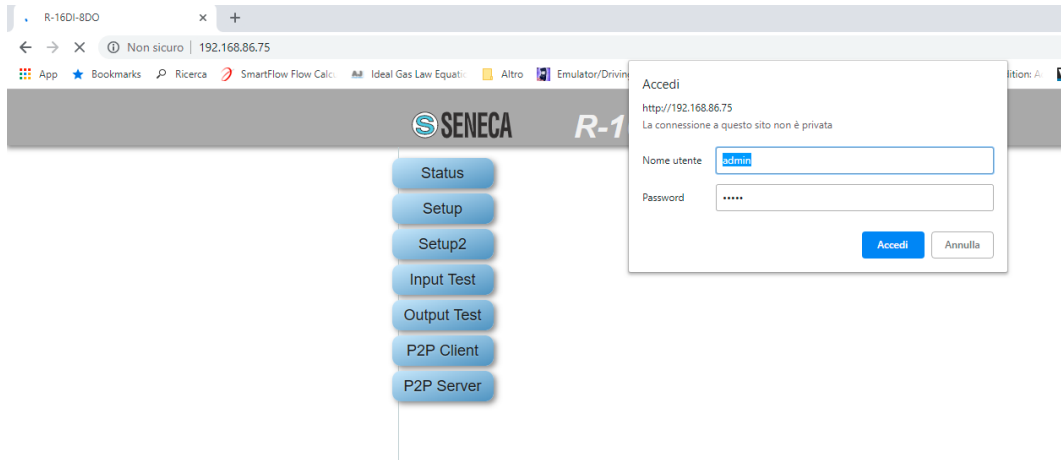

 **ATTENTION!**

IF THE PARAMETERS TO ACCESS THE WEB SERVER HAVE BEEN LOST, IT IS NECESSARY TO RESET THE FACTORY-SET CONFIGURATION

 **ATTENTION!**

AVOID INSERTING SPECIAL CHARACTERS IN THE PROFINET NAME OF THE DEVICE

## 5. EXAMPLE OF CREATING A PROJECT WITH SIEMENS PLC (TIA PORTAL 16)

Creating a new project:

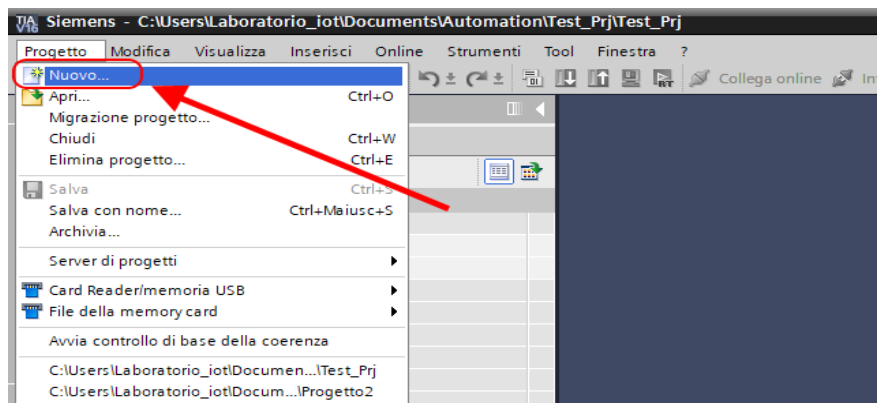

### 5.1. INSTALLING THE GSDML FILE

Install the GSDML file of the Seneca product (it is possible to obtain the file on the web page of the device on the [www.seneca.it](http://www.seneca.it) site):

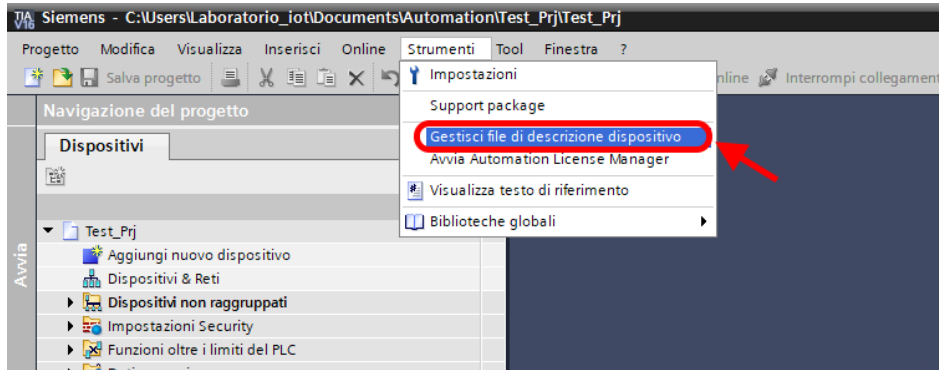

Point to the directory where the file is and press OK, then the list of GSD files in the folder will appear:

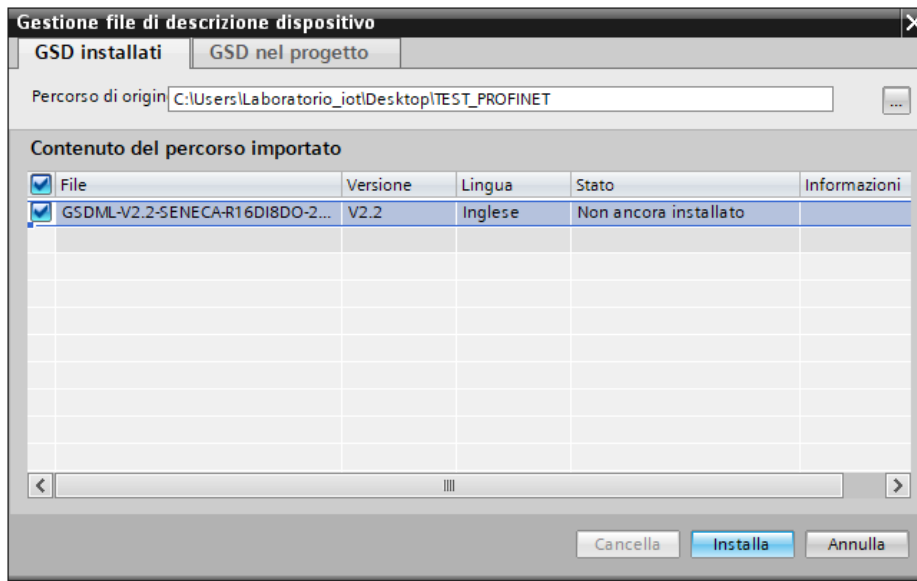

Click on "install".

## 5.2. INSERTION OF THE SIEMENS PLC IN THE PROJECT

Now insert the Siemens PLC (in our example a SIEMATIC S7 1200), click on "Add new device ...":

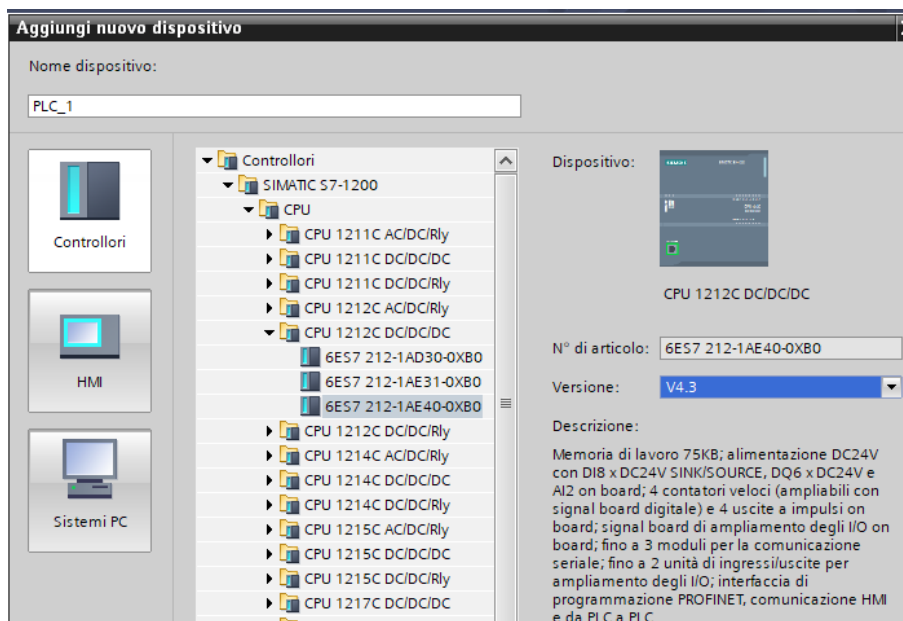
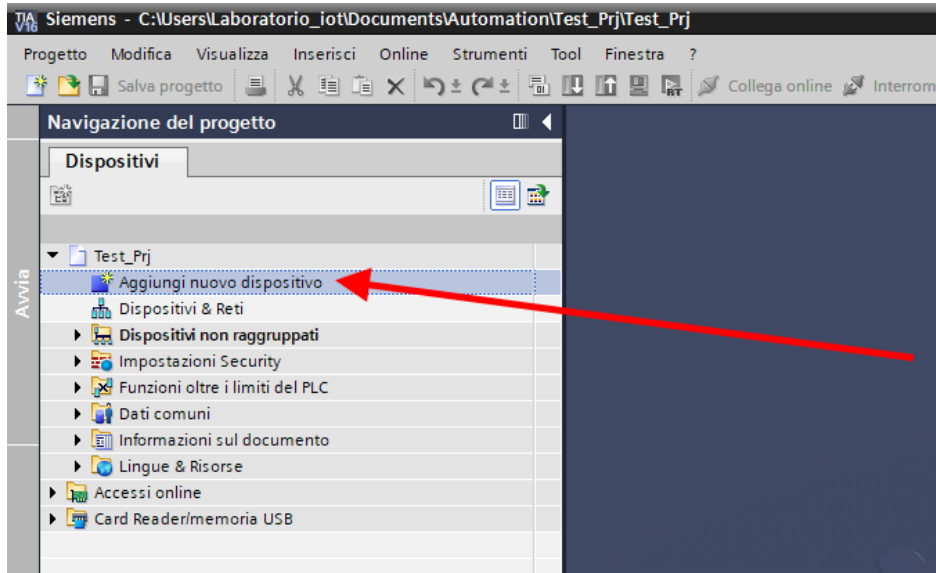

Confirm and the PLC will be added to the rack:

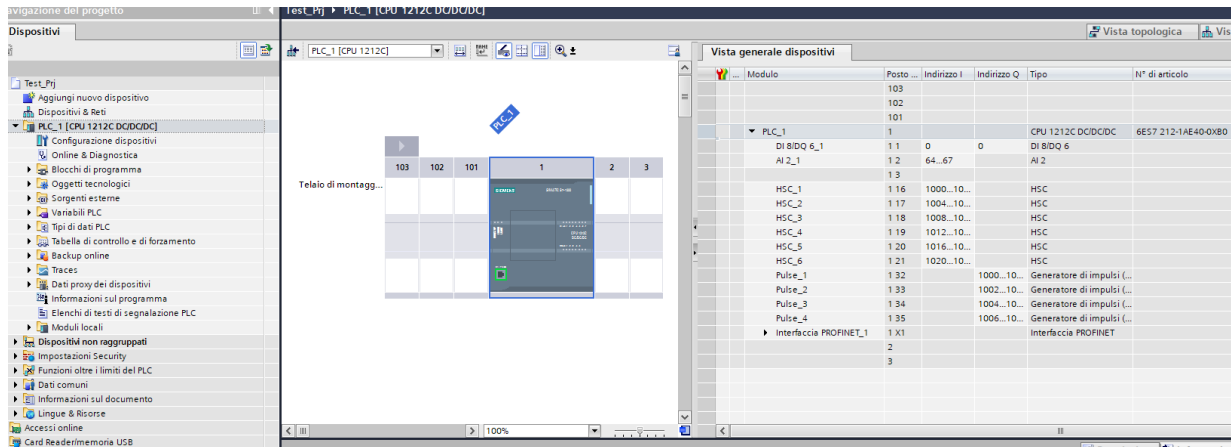

Now click on the PLC and select Profinet interface -> Ethernet addresses

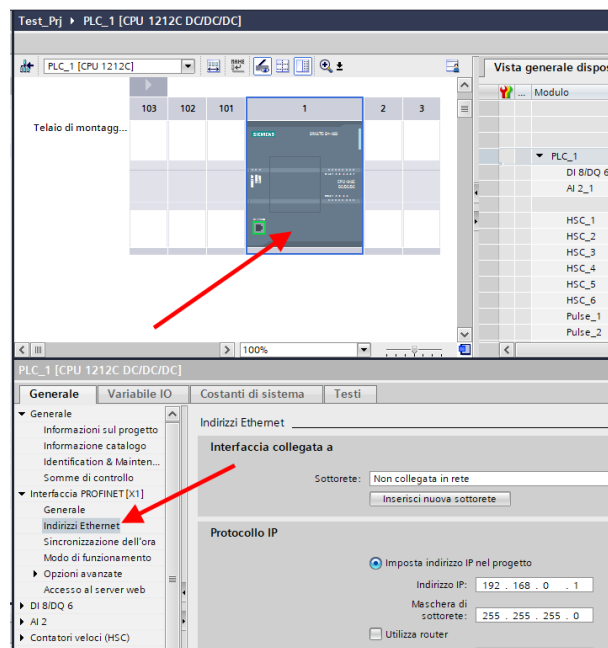



Set the IP you want (in this case 192.168.90.44) and the PLC subnet:

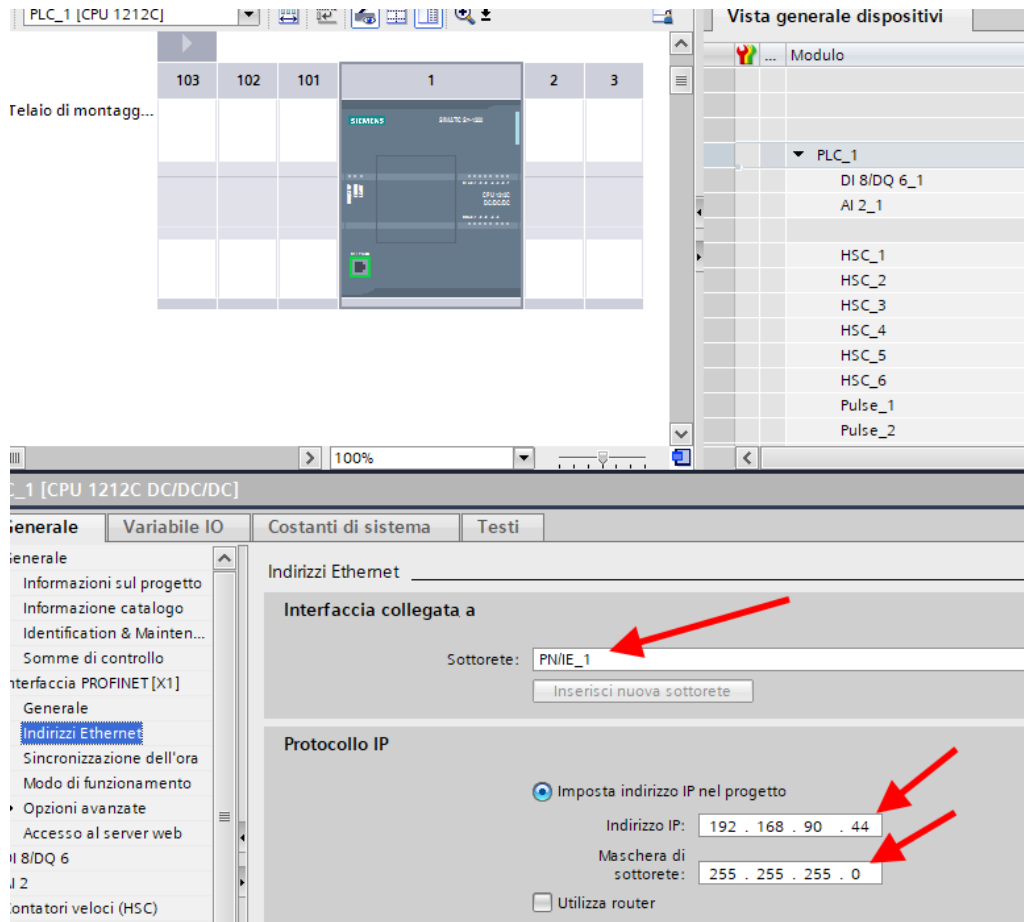

Move on to the network view:

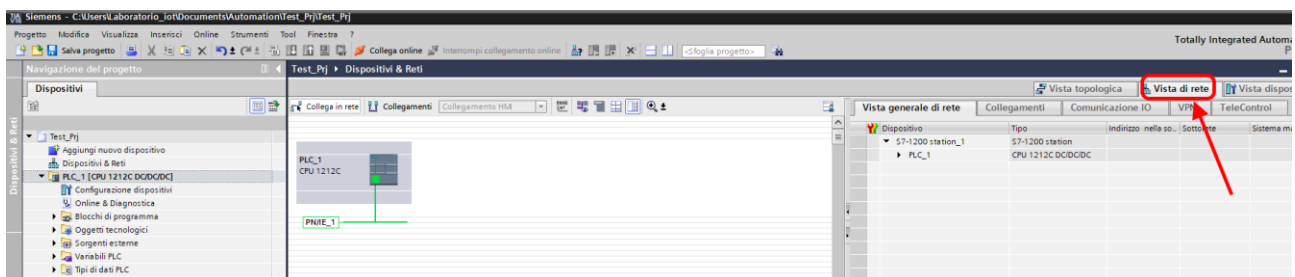

### 5.3. INSERTION OF THE PROFINET SENECA IO

On the right, select "Hardware Catalogue" and then under "Additional Field Device" -> PROFINET IO -> I/O -> Seneca R-Series-> Header module (in the example an R-16DI-8DO device is shown):

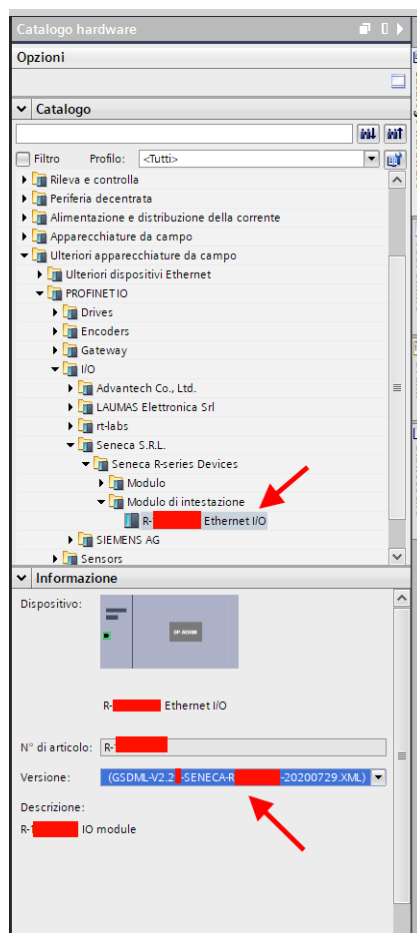

Drag the device to the network view:

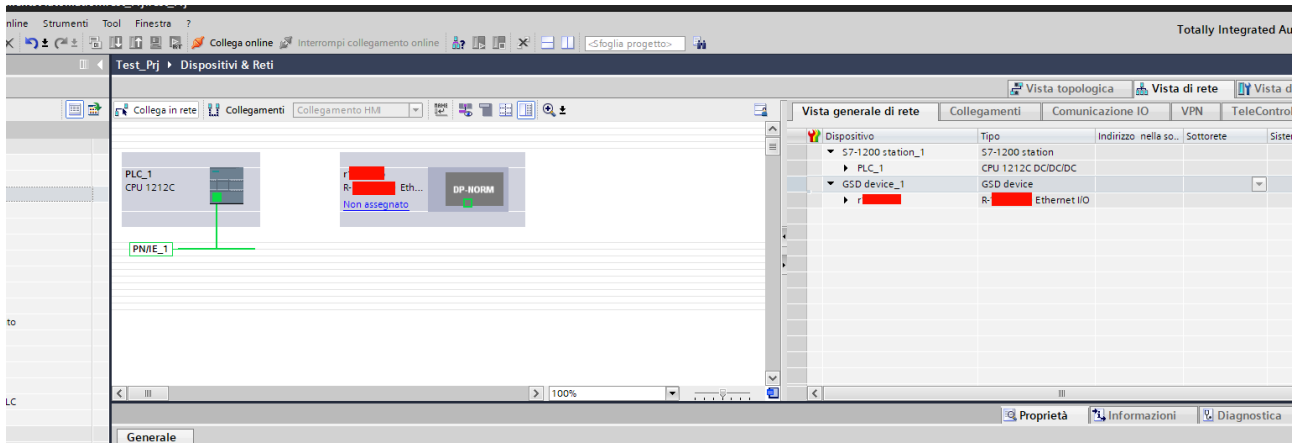

Now associate it to the PLC by clicking with the left mouse on "Not assigned" and then select the PLC:

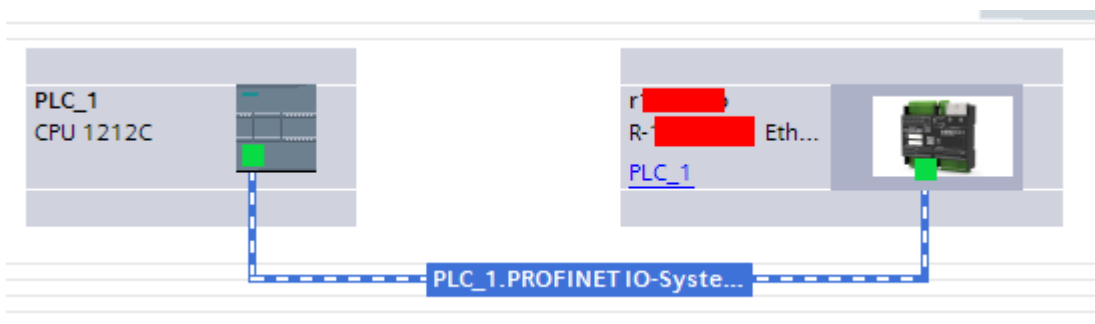
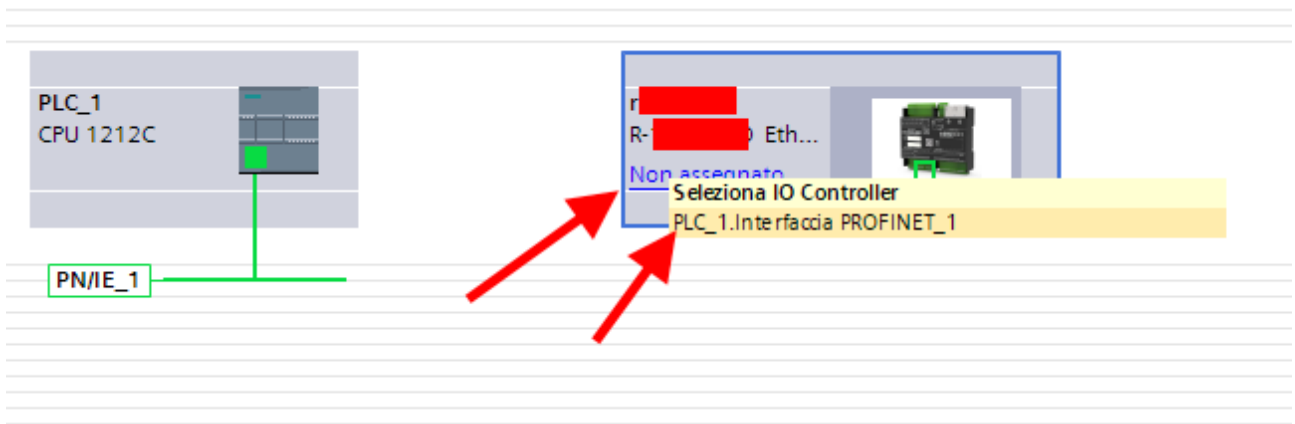

Click twice on the Seneca device and configure the IP address here too (for example 192.168.90.48):

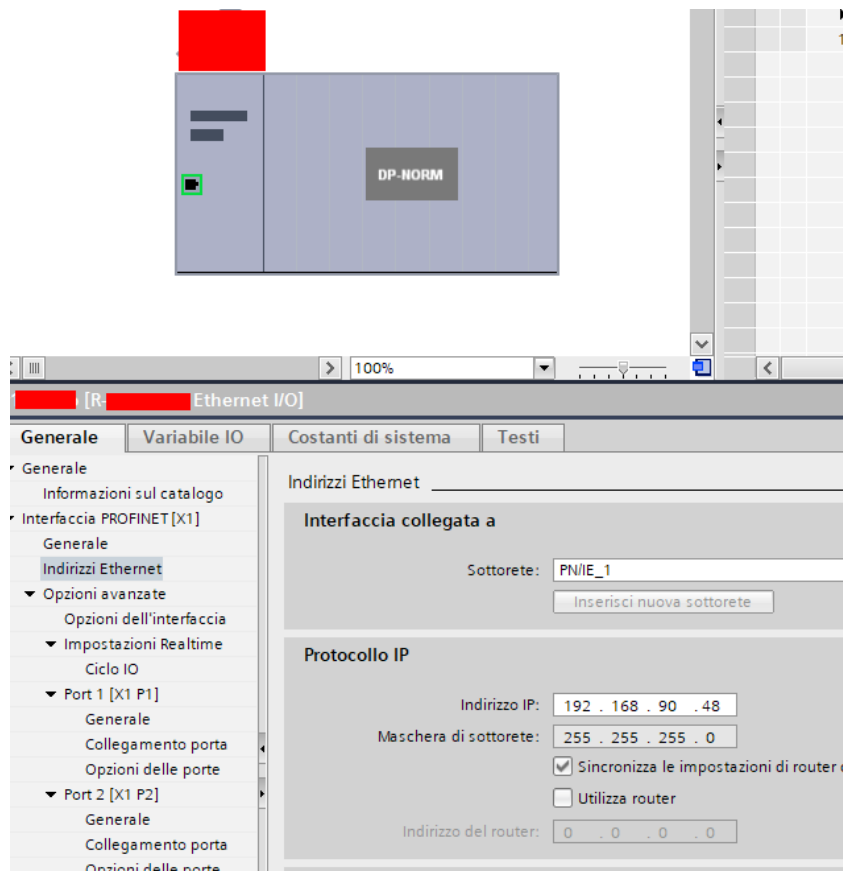

In Profinet the devices are identified by their name, so right click on the Seneca device and select "Assign device name"

## ATTENTION!

**AVOID INSERTING SPECIAL CHARACTERS IN THE PROFINET NAME OF THE DEVICE**

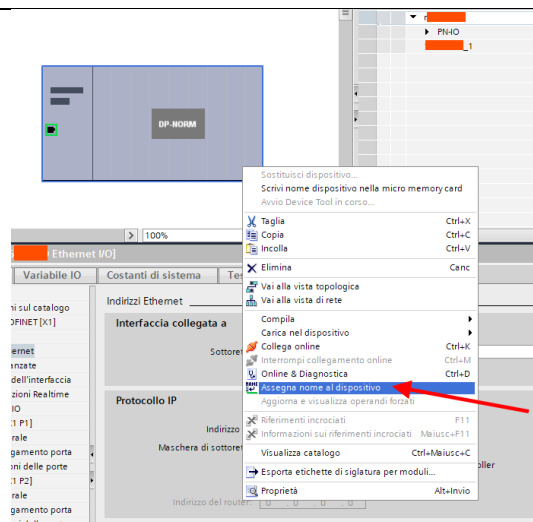

Scan the network with "Update list" and set (if necessary) the device name with "Assign name".

### 5.4. CONFIGURATION OF THE PARAMETERS OF THE SENECA DEVICE

It is also possible to directly configure the device IO without any external software. To configure the device, click on the IO so that the "Unit parameters" appear:

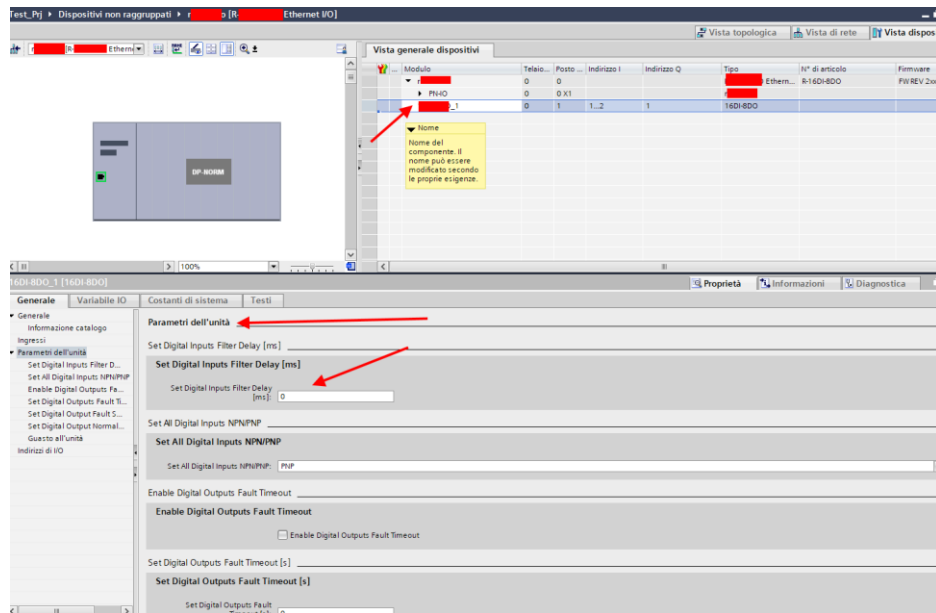

At the next start, the PLC will send the desired configuration to the device.

## 5.5. CONFIGURATION PARAMETERS OF THE GSDML FILE

### 5.5.1. R-32DIDO-P

#### **SET DIGITAL IO INPUT/OUTPUT**

Selects whether the selected input will work as an input or output.

#### **SET DIGITAL INPUT NORMALLY HIGH/LOW**

If selected as digital input, it configures whether the input is normally high or low.

#### **SET DIGITAL OUTPUT NORMALLY OPEN/CLOSE**

If selected as digital output, it configures whether the output is normally open or closed.

#### **SET DIGITAL OUTPUT WATCHDOG**

If selected as digital output, it sets the output watchdog mode.

If "Disabled", it disables the watchdog function for the selected output.

If "Enabled on Profinet Communication" the output goes into "Watchdog state" if there has been no generic Profinet communication within the set time.

#### **SET DIGITAL OUTPUT WATCHDOG STATE**

Sets the value that the digital output must adopt if the watchdog has been triggered.

#### **SET DIGITAL OUTPUT WATCHDOG TIMEOUT [s]**

Represents the watchdog time of the digital output in seconds. If the PLC stops communicating with the device within the set time, then the outputs will go into the "Watchdog state" condition (if the function is enabled).

### 5.5.2. R-16DI-8DO-P

#### **SET DIGITAL INPUTS FILTER DELAY [ms]**

Sets the filtering of the counters, the value is expressed in [ms].

The filter cut-off frequency corresponds to:

$$f_{cut}[Hz] = 1000 / (2 * Counters Filter [ms])$$

For example, if the filter counter is 100ms the cutting frequency will be:

$$f_{cut}[Hz] = 1000 / (2 * Counters Filter [ms]) = 5 Hz$$

So all input frequencies greater than 5 Hz will be cut.

#### **SET ALL DIGITAL INPUTS NPN/PNP**

Sets the input operating mode to between npn "Sink" and pnp "Source"

#### **ENABLE DIGITAL OUTPUTS FAULT TIMEOUT**

Set whether the digital output watchdog is to activated. When enabled, if within the timeout time there has been no communication from the master to the device, the outputs go into a Fail state. This mode allows to obtain a safe system in case of malfunction of the master.

***SET DIGITAL OUTPUTS FAULT TIMEOUT [s]***

Set the watchdog time of the digital outputs.

***SET DIGITAL OUTPUT FAULT STATES OPEN/CLOSE***

They set the states of each of the outputs under normal conditions.

***SET DIGITAL OUTPUT NORMALLY OPEN/CLOSE***

They set the states of each of the outputs in fail conditions.

**5.5.3. R-8AI-8DIDO-P*****SET DIGITAL IO INPUT/OUTPUT***

Selects whether the selected input will work as an input or output.

***SET DIGITAL INPUT NORMALLY HIGH/LOW***

If selected as digital input, it configures whether the input is normally high or low.

***SET DIGITAL OUTPUT NORMALLY OPEN/CLOSE***

If selected as digital output, it configures whether the output is normally open or closed.

***SET DIGITAL OUTPUT WATCHDOG***

If selected as digital output, it sets the output watchdog mode.

If "Disabled", it disables the watchdog function for the selected output.

If "Enabled on Profinet Communication" the output goes into "Watchdog state" if there has been no generic Profinet communication within the set time.

***SET DIGITAL OUTPUT WATCHDOG STATE***

Sets the value that the digital output must adopt if the watchdog has been triggered.

***SET DIGITAL OUTPUT WATCHDOG TIMEOUT [s]***

Represents the watchdog time of the digital output in seconds. If the PLC stops communicating with the device within the set time, then the outputs will go into the "Watchdog state" condition (if the function is enabled).

**SET ANALOG MODE**

Set the type of measurement for the selected input.

It is possible to choose between the following types of input:

+/-100mV

+/-30V

+/-24 mA

Thermocouple

PT100 3 wires (only for analog input 1).

**SAMPLING TIME**

Set the sampling time of the channel, selectable between 4 ms and 400 ms, it is also possible to disconnect the input.

**SET ANALOG INPUT MOVING FILTER (10 SAMPLES)**

Set whether or not to activate the 10-sample moving average filter.

**SET ANALOG INPUTS MEASURE OFFSET**

Set an offset for analog measurements

**SET INPUT START/END SCALE**

Represents the start of the electrical scale of the analog measurement used for the register of the engineering measurement.

The value to enter is in the unit of measurement based on the type of input chosen [V], or [mV], or [uA], or [°C]

**SET INPUT START/END ENG. SCALE**

Represents the electrical full scale of the analog measurement used for the engineering measurement register.

Example:

ANALOG INPUT START SCALE = 4 [mA]

ANALOG INPUT STOP SCALE = 20 [mA]

ANALOG INPUT ENG STOP SCALE = -200 [metri]

ANALOG INPUT ENG START SCALE = 200 [metri]

With a 12 mA input the engineering value will be 0 metres.

**SET ANALOG INPUTS TC TYPE**

In the case of thermocouple measurement, it allows to select the type of thermocouple between: J, K, R, S, T, B, E, N, L

**SET ANALOG INPUTS TC COLD JUNCTION MODE**

In the case of thermocouple measurement, it enables or disables the automatic cold junction offset of the device.

**SET ANALOG INPUTS TC COLD JUNCTION OFFSET**



In the case of thermocouple measurement, set an offset in the cold junction measurement in [°C]

#### **SET ANALOG INPUTS TC BURNOUT MODE**

In the case of thermocouple measurement, it selects the behaviour in case of sensor failure: In the case of "Last Value" the value is stopped at the last valid value, in the case of "Fail Value" the "Burnout" value is loaded in the registers.

#### **SET ANALOG INPUTS TC BURNOUT VALUE**

In the case of thermocouple measurement, if the ANALOG INPUT BURNOUT MODE = "FAIL VALUE" mode is activated and the sensor is in the "burn" state, it allows you to set a value in °C to be taken by the measurement register.

#### **PT100 3 WIRE**

Allows you to choose whether the temperature value detected by input 1 is used for cold junction compensation of all TCs (which have cold junction compensation enabled) or as a temperature measurement.

#### **5.5.4. R-SG3-P**

 **ATTENTION!**

**FROM FIRMWARE REVISION 1005 THE DEVICE PARAMETERS CAN ALSO BE CONFIGURED IN REAL TIME FROM THE PLC BY OVERWRITING THE INITIAL CONFIGURATION.**

#### **FUNCTION MODE**

It allows to configure the basic operation of the device, can be set to factory calibration or to Calibration with standard weight:

##### **FACTORY CALIBRATION**

It is used when a load cell with declared sensitivity is available.

In this mode, calibration only consists in acquiring the tare directly in the field with a direct measurement. If it is not possible to acquire the tare with a direct measurement (for example in the case of an already filled silo) it is possible to manually enter the tare value in the desired unit of measurement (kg, t, etc.).

##### **CALIBRATION WITH STANDARD WEIGHT**

It is used when a standard weight is available (as far as possible towards the load cell full scale). In this mode the calibration consists in acquiring both the tare and the standard weight directly on the field.

#### **MEASURE TYPE**

It allows to configure the operation of the device between:

***BALANCE (UNIPOLAR)***

It is used when a scale is being created in which the load cell is only compressed, in this case the maximum resolution of the compression measurement is obtained.

***COMPRESSION AND TRACTION (BIPOLAR)***

It is used when a measurement system (typically of force) is being created that can both compress and extend the load cell. In this case the direction of the force can also be decided, if compression the measurement will have the + sign, if traction it will have the - sign. A typical case of use is to link the direction of the force to the analog output so that, for example, 4mA correspond to the maximum traction force and 20mA correspond to the maximum compression force (in this case the cell at rest will provide 12Ma).

***MEASURE UNIT***

Sets the unit of measurement for the weighing in g, Kg, etc.

***CELL SENSITIVITY***

It is the declared cell sensitivity value expressed in mV/V (in most cells it is 2mV/V).

***CELL FULL SCALE***

It is the full scale value of the cell expressed in the selected unit of measurement.

***STANDARD WEIGHT VALUE***

It represents the value of the standard weight that will be used in the calibration if the operating mode with standard weight has been chosen.

***NOISE FILTER***

Enables or disables measurement filtering.

***FILTER LEVEL***

Allows you to set the measurement filter level according to the following table:

FILTER LEVEL	RESPONSE TIME [ms]
0	2
1	6.7
2	13
3	30
4	50
5	250
6	850
ADVANCED	Configurable

The higher the filter level the more stable (but slow) the weight measurement will be.

If you select the advanced filtering level (Advanced), the configuration will allow you to select the following parameters:

**ADC SPEED** Selects the ADC acquisition speed from 4.7 Hz to 960 Hz

**NOISE VARIATION** It is the variation in ADC points due to noise alone (represents the measurement uncertainty due to noise) or how much we expect the measurement to vary (the unit of measurement is in raw ADC points).

### **FILTER RESPONSE SPEED**

Represents a parameter related to the filter response speed, it can vary from 0.001 (slowest response) to 1 (fastest response). Represents the variance of the process.

### **NET WEIGHT RESOLUTION**

It is the resolution with which the value of the net weighing is represented, it can be worth:

#### **MAXIMUM RESOLUTION**

It will represent the net weight with the highest possible resolution

#### **MANUAL**

It will represent the net weight with the manual resolution set (in engineering units).

For example, by setting 0.1 Kg you will get that the net weight can only vary by multiples of 100g.

#### **AUTOMATIC RESOLUTION**

It will represent the net weight with a calculated resolution of about 20000 points. Unlike Maximum or Manual resolution, this setting limits also the ADC value and therefore affects all measurements.



## CAUTION

Keep in mind that in the "Calibration with standard weight" mode, using the "Manual Resolution", the correct standard weight value may not be perfectly represented:

For example, you have:

Cell full scale 15000 g  
 Standard weight 14000 g  
 Manual Resolution 1.5 g

The value of the standard weight (14000 g) cannot be represented with the resolution in 1.5g steps (14000/1.5g = 9333.333 is not an integer value) so it will be represented as: 9333\*1.5g = 13999.5g  
 To avoid this effect, use a resolution that allows the value to be represented (for example 1g or 2g).

### **SAMPLE PIECE WEIGHT**

Sets the weight of a single piece in technical units for the mode. By setting the net weight of a single element in this register, the converter will be able to indicate the number of pieces present in the scales special register according to the relation:

$$Nr\ Pezzi = \frac{Peso\ Netto}{Peso\ Pezzo\ Campione}$$

### **AUTOMATIC TARE TRACKER**

It allows you to enable or disable the automatic tare reset.

### **ADC VALUE**

It allows to set the number of ADC points within which to reset the tare automatically.

If after 5 seconds of stable weighing condition the ADC value of the net weight deviates by less than this value then a new tare is acquired.

### **DELTA WEIGHT**

Weight variation that contributes to the definition of "Stable Weight"

### **DELTA TIME [x100ms]**

Time variation that contributes to the definition of "Stable Weight"

**STABLE WEIGHT** (Stable weighing condition)

The stable weighing condition is used to indicate that the net weight measurement is stable if:

The net weight remains within the weight  $\Delta peso\_netto$  over time  $\Delta tempo$  or if the slope of the curve drawn by the net weight is less than  $\frac{\Delta peso\_netto}{\Delta tempo}$  :

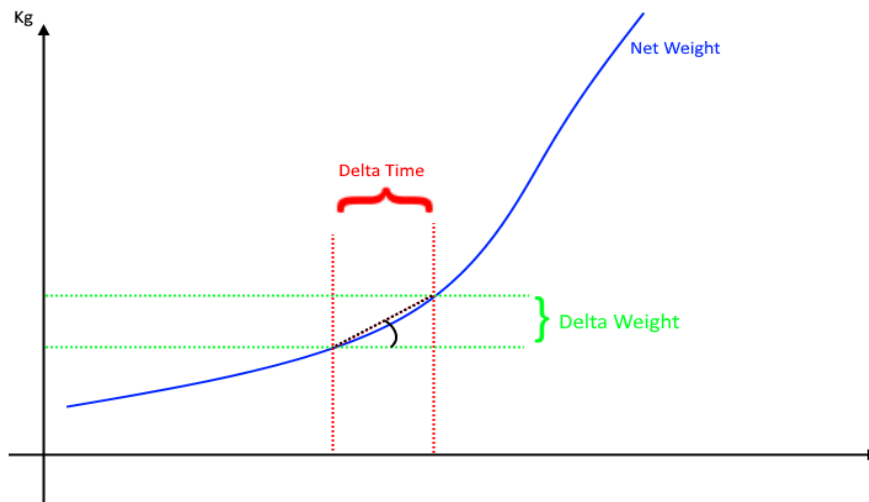

You will be prompted to enter Delta Net Weight (**Delta Weight**) (in engineering units) and Delta Time (**Delta Time**) (in 0.1 seconds).

**ANALOG OUTPUT WORKING MODE**

Select whether the analogue output is linked to the net measurement or controlled by the Profinet io protocol.

**ANALOG OUTPUT TYPE**

Select whether the analogue output is Voltage or Current

**DIGITAL I/O MODE**

Configure the device's digital I/O as input or output

**FUNCTION**

Configure the operation if the I/O is configured as a digital input:

**ACQUIRE TARE**

In this mode, if the digital input is activated for a time longer than 3 seconds, a new tare value is acquired (in RAM, then it is lost upon restart). It is equivalent to sending the command 49594 (decimal) in the command register.

**DIGITAL INPUT**

The input is configured as a digital input whose value can be read from the appropriate register.

**DIGITAL OUTPUT MODE**

In the case of configuring the I/O as a digital output it is possible to choose whether this should be configured as normally open (**Normally Open**) or as normally closed (**Normally Close**)

**DIGITAL OUTPUT CONFIGURATION**

Here you can choose the behaviour of the digital output:

**FULL SCALE CELL**

The digital output is activated if the cell has reached the measurement full scale.

**THRESHOLD AND STABLE WEIGHT**

In this mode, the output activates when the net weight reaches the threshold and the weigh is in a stable weighing condition

**STABLE WEIGHT**

The stable weighing condition is used to indicate that the net weight measurement is stable if:

The net weight remains within the weight  $\Delta peso\_netto$  over time  $\Delta tempo$  or if the slope of the curve drawn by the net weight is less than  $\frac{\Delta peso\_netto}{\Delta tempo}$  :

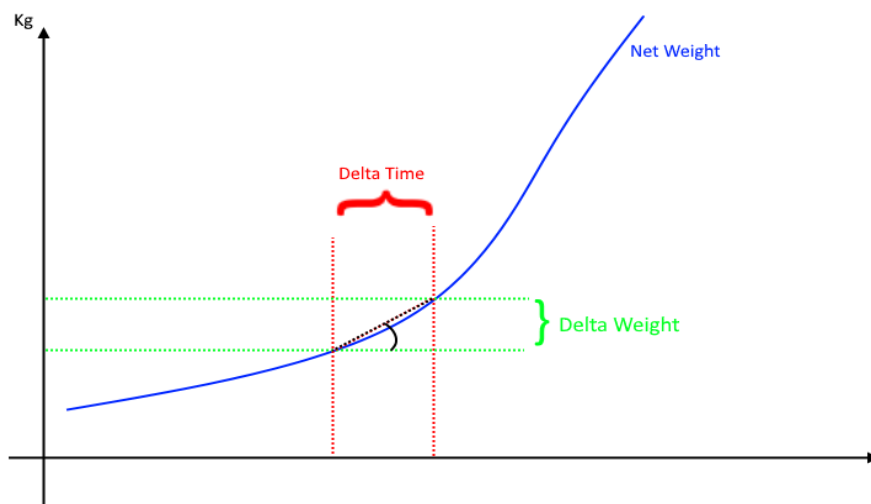

**STABLE WEIGHT**

In this mode the output is activated if the weighing is in the stable weighing condition.

**COMMANDABLE FROM PROFINET**

In this mode the digital output can be controlled by the Profinet IO protocol.

**THRESHOLD WITH HYSTERESIS**

In this mode the output is activated when the net weight reaches the threshold, the alarm is cancelled when the net weight falls below the Threshold-Hysteresis value:

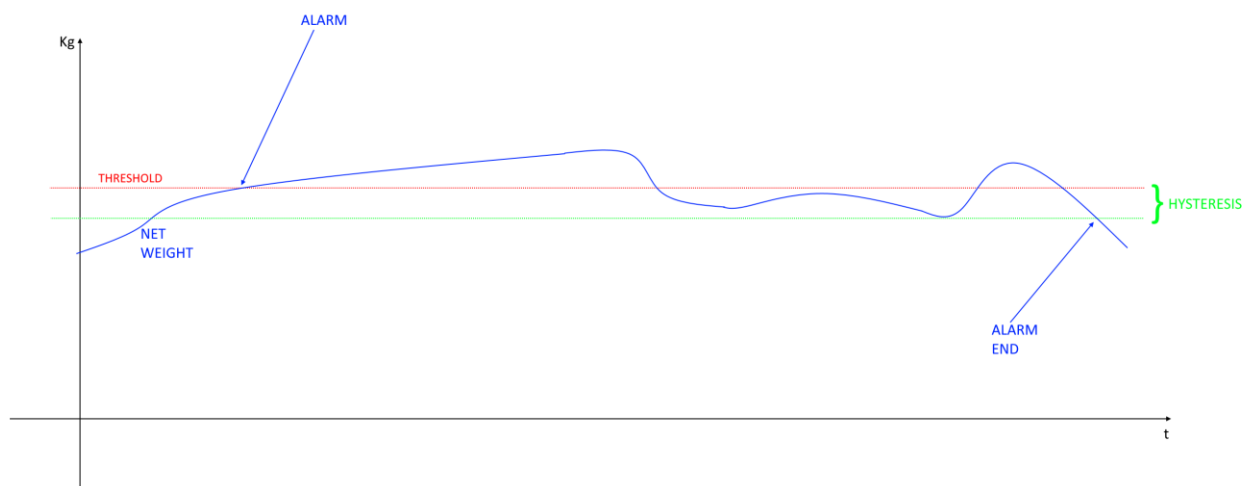

### 5.5.5. R-4AO-8DIDO-P

#### **SET ANALOG MODE**

Sets the type of output from -10 to +10 V or from 0 to 20 mA

#### **SET ANALOG OUTPUT WATCHDOG**

Set the watchdog mode of the analog outputs.

If “Disabled”, it disables the watchdog function for the selected output.

If “Enabled on Profinet Communication” the output loads the value “AO watchdog fault value” if there has not been a Profinet communication within the set time.

#### **SET ANALOG OUTPUT WATCHDOG TIMEOUT [s]**

Represents the watchdog time of the analog output in seconds. If the PLC stops communicating with the device within the set time, then the output will load the value set in “AO watchdog fault value” (if the function is enabled).

#### **SET ANALOG WATCHDOG OUTPUT START/FAULT VALUE**

Sets the value that the analog output must adopt at startup and if the watchdog has been triggered.

#### **SET START/END ELECTRICAL SCALE**

Represents the electrical start and end scale of the analog output used for the engineering measurement register (scaled).

The value to enter is in the unit of measurement of output chosen [mV], or [uA]

#### **SET START/END ELECTRICAL SCALE**

Represents the engineering start and end scale of the analog output

Example:

ANALOG START ELECTRICAL SCALE = 4000 [uA]

ANALOG END ELECTRICAL SCALE = 20000 [uA]

ANALOG START ENG. SCALE = -200 [meters]

ANALOG END ENG. SCALE = 200 [meters]

We will have that by writing:

The output at -200 will provide 4 mA

The output at 0 will provide 12 mA

The output at +200 will provide 20 mA



 **ATTENTION!**

**IF YOU SET STAR/END ELECTRICAL SCALE AND START/END ENG. SCALE AT 0 THE SCALE IS NOT ACTIVE AND THE OUTPUT WILL BE DRIVEN DIRECTLY IN [mV] or [uA]**

**SET DIGITAL IO INPUT/OUTPUT**

Selects whether the selected digital input will work as an input or output.

**SET DIGITAL INPUT NORMALLY HIGH/LOW**

If selected as digital input, it configures whether the input is normally high or low.

**SET DIGITAL OUTPUT NORMALLY OPEN/CLOSE**

If selected as digital output, it configures whether the output is normally open or closed.

**SET DIGITAL OUTPUT WATCHDOG**

If selected as digital output, it sets the output watchdog mode.

If "Disabled", it disables the watchdog function for the selected output.

If "Enabled on Profinet Communication" the output goes into "Watchdog state" if there has been no generic Profinet communication within the set time.

**SET DIGITAL OUTPUT WATCHDOG STATE**

Sets the value that the digital output must adopt if the watchdog has been triggered.

**SET DIGITAL OUTPUT WATCHDOG TIMEOUT [s]**

Represents the watchdog time of the digital output in seconds. If the PLC stops communicating with the device within the set time, then the outputs will go into the "Watchdog state" condition (if the function is enabled).

### 5.5.6. R-4RTD-8DIDO-P

#### **SET RTD SENSOR**

Sets the type of sensor connected to the input.

You can choose between the following sensors:

PT100  
Ni100  
PT500  
PT1000  
Cu50  
Cu100  
Ni120  
Ni1000

#### **SAMPLING TIME**

Sets the sampling time of the channel (each channel is independent)

#### **SET ANALOG MOVING FILTER**

Allows you to set whether or not to activate on the analog measurement the 10-sample moving average filter.

#### **SET TEMPERATURE MEASURE OFFSET**

Allows you to set a channel temperature offset.

#### **ANALOG INPUT START SCALE**

Represents the start of the electrical scale of the analog measurement used for the register of the engineering measurement.

#### **ANALOG INPUT STOP SCALE**

Represents the electrical full scale of the analog measurement used for the engineering measurement register.

#### **ANALOG INPUT ENG START SCALE**

It represents the value of the engineering measurement register when the input reaches the value shown in the ANALOG INPUT START SCALE parameter.

For example if:

ANALOG INPUT START SCALE = 0 °C  
ANALOG INPUT STOP SCALE = 100 °C  
ANALOG INPUT ENG STOP SCALE = -200  
ANALOG INPUT ENG START SCALE = 200

With a 50 °C input the engineering value will be 0.

***ANALOG INPUT ENG STOP SCALE***

It represents the value of the engineering measurement register when the input reaches the value shown in the ANALOG INPUT STOP SCALE parameter.

For example if:

ANALOG INPUT START SCALE = 0 °C

ANALOG INPUT STOP SCALE = 100 °C

ANALOG INPUT ENG STOP SCALE = -200

ANALOG INPUT ENG START SCALE = 200

With a 50 °C input the engineering value will be 0.

***CONNECTION WIRES***

Allows you to select the connection type with the sensors of 2, 3 or 4 wires.

***WIRES CONNECTION RESISTANCE [Ohm]***

Allows you to select the possible resistance of connection cables.

***UNIT MEASURE***

Allows you to select the channel unit of measurement among °C, K, °F, Ohm.

***FAULT MODE***

Allows you to set the behaviour in case of channel fault between "Last valid Value" or "Fail value"

***FAIL VALUE***

Allows you to set the channel fail value.

***BURN SENSOR DETECT***

Allows you to activate or deactivate the speed detect of sensor burn state.

***BURN SENSOR SAMPLING TIME (s)***

Allows you to set how often the measurement must be taken to detect the channel burn state.

***SET DIGITAL IO INPUT/OUTPUT***

Selects whether the selected digital input will work as an input or output.

***SET DIGITAL INPUT NORMALLY HIGH/LOW***

If selected as digital input, it configures whether the input is normally high or low.

***SET DIGITAL OUTPUT NORMALLY OPEN/CLOSE***

If selected as digital output, it configures whether the output is normally open or closed.

**SET DIGITAL OUTPUT WATCHDOG**

If selected as digital output, it sets the output watchdog mode.

If "Disabled", it disables the watchdog function for the selected output.

If "Enabled on Profinet Communication" the output goes into "Watchdog state" if there has been no generic Profinet communication within the set time.

**SET DIGITAL OUTPUT WATCHDOG STATE**

Sets the value that the digital output must adopt if the watchdog has been triggered.

**SET DIGITAL OUTPUT WATCHDOG TIMEOUT [s]**

Represents the watchdog time of the digital output in seconds. If the PLC stops communicating with the device within the set time, then the outputs will go into the "Watchdog state" condition (if the function is enabled).

**5.6. R-32DIDO-P I/O DATA**

Define the PLC tags directly in the "standard tag table":

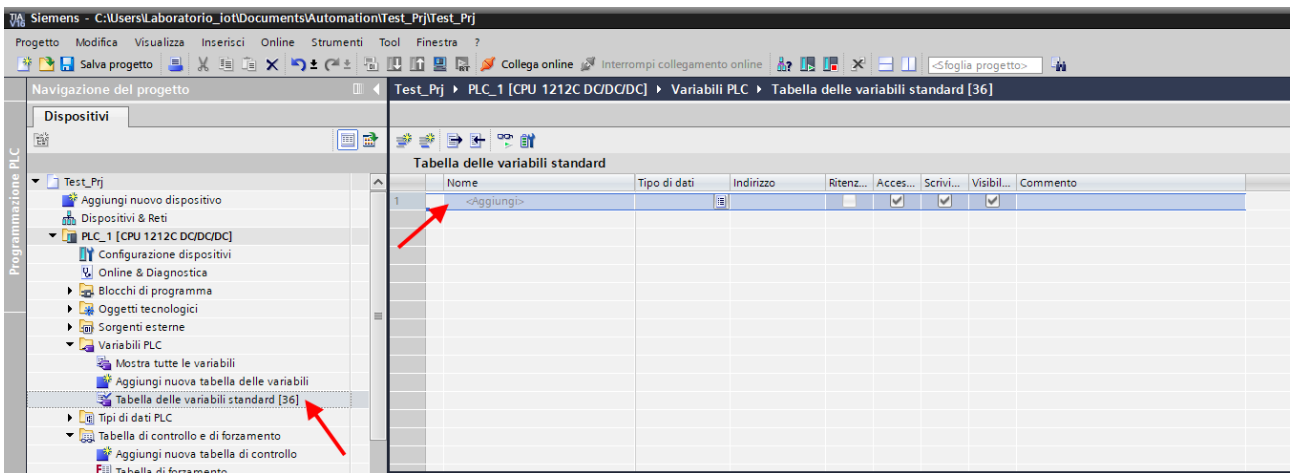

Now let's add the variables related to the IO, the addresses are shown here:

Vista generale dispositivi								
...	Modulo	Telaio...	Posto ...	Indirizzo I	Indirizz...	Tipo	N° di articolo	Fi
	▼ r32didop	0	0			R-32DIDO-P Ethern...	R-32DIDO-P	FV
	▶ PN-IO	0	0 X1			r32didop		
	32DIDO	0	1	1...4	1...4	32DIDO		

So:

The bytes from I1 to I4 contain the inputs (bit 0 is IO1, bit 1 is IO2 etc.)

Bytes Q1 to Q4 contain the outputs (bit 0 is IO1, bit 1 is IO2 etc ...), obviously only the outputs are writable.

Below is the default mapping of available IOs:

<b>INPUT/OUTPUT</b>	<b>DEFAULT ADDRESS IO CONFIGURED AS AN INPUT</b>	<b>DEFAULT ADDRESS IO CONFIGURED AS AN OUTPUT</b>
IO1	I1.0	Q1.0
IO2	I1.1	Q1.1
IO3	I1.2	Q1.2
IO4	I1.3	Q1.3
IO5	I1.4	Q1.4
IO6	I1.5	Q1.5
IO7	I1.6	Q1.6
IO8	I1.7	Q1.7
IO9	I2.0	Q2.0
IO10	I2.1	Q2.1
IO11	I2.2	Q2.2
IO12	I2.3	Q2.3
IO13	I2.4	Q2.4
IO14	I2.5	Q2.5
IO15	I2.6	Q2.6
IO16	I2.7	Q2.7
IO17	I3.0	Q3.0
IO18	I3.1	Q3.1
IO19	I3.2	Q3.2
IO20	I3.3	Q3.3
IO21	I3.4	Q3.4
IO22	I3.5	Q3.5
IO23	I3.6	Q3.6
IO24	I3.7	Q3.7
IO25	I4.0	Q4.0
IO26	I4.1	Q4.1
IO27	I4.2	Q4.2
IO28	I4.3	Q4.3
IO29	I4.4	Q4.4
IO30	I4.5	Q4.5
IO31	I4.6	Q4.6
IO32	I4.7	Q4.7

So if, for example, I need 16 inputs and 16 outputs, I can use the Booleans from I1.0 to I2.7 for the inputs (which will therefore be found in the IO1 ... IO16) and the Booleans from Q3.0 to Q4.7 for the outputs (which will then be found in the IO17 ... IO32).



## ATTENTION!

An IO configured as an input cannot be controlled as an output.  
An IO configured as an output cannot be read as an input.

Always following our example (16 inputs and 16 outputs) we define the 16 inputs and 16 outputs in the standard variables table:

Progetto\_R32DIDO ▶ PLC\_1 [CPU 1211C DC/DC/DC] ▶ Tabella di controllo e di forzamento ▶ Tabella d

	i	Nome	Indirizzo	Formato visualizz..	Valore di controllo	Valore di comando	
1		*IN1*	%I1.0	Bool	TRUE		<input type="checkbox"/>
2		*IN2*	%I1.1	Bool	TRUE		<input type="checkbox"/>
3		*IN3*	%I1.2	Bool	TRUE		<input type="checkbox"/>
4		*IN4*	%I1.3	Bool	TRUE		<input type="checkbox"/>
5		*IN5*	%I1.4	Bool	FALSE		<input type="checkbox"/>
6		*IN6*	%I1.5	Bool	FALSE		<input type="checkbox"/>
7		*IN7*	%I1.6	Bool	FALSE		<input type="checkbox"/>
8		*IN8*	%I1.7	Bool	FALSE		<input type="checkbox"/>
9		*IN9*	%I2.0	Bool	TRUE		<input type="checkbox"/>
10		*IN10*	%I2.1	Bool	FALSE		<input type="checkbox"/>
11		*IN11*	%I2.2	Bool	FALSE		<input type="checkbox"/>
12		*IN12*	%I2.3	Bool	FALSE		<input type="checkbox"/>
13		*IN13*	%I2.4	Bool	FALSE		<input type="checkbox"/>
14		*IN14*	%I2.5	Bool	FALSE		<input type="checkbox"/>
15		*IN15*	%I2.6	Bool	FALSE		<input type="checkbox"/>
16		*IN16*	%I2.7	Bool	FALSE		<input type="checkbox"/>
17		*OUT17*	%Q3.0	Bool			<input type="checkbox"/>
18		*OUT18*	%Q3.1	Bool			<input type="checkbox"/>
19		*OUT19*	%Q3.2	Bool			<input type="checkbox"/>
20		*OUT20*	%Q3.3	Bool			<input type="checkbox"/>
21		*OUT21*	%Q3.4	Bool			<input type="checkbox"/>
22		*OUT22*	%Q3.5	Bool			<input type="checkbox"/>
23		*OUT23*	%Q3.6	Bool			<input type="checkbox"/>
24		*OUT24*	%Q3.7	Bool			<input type="checkbox"/>
25		*OUT25*	%Q4.0	Bool			<input type="checkbox"/>
26		*OUT26*	%Q4.1	Bool			<input type="checkbox"/>
27		*OUT27*	%Q4.2	Bool			<input type="checkbox"/>
28		*OUT28*	%Q4.3	Bool			<input type="checkbox"/>
29		*OUT29*	%Q4.4	Bool			<input type="checkbox"/>
30		*OUT30*	%Q4.5	Bool			<input type="checkbox"/>
31		*OUT31*	%Q4.6	Bool			<input type="checkbox"/>
32		*OUT32*	%Q4.7	Bool			<input type="checkbox"/>
33		<Aggiungi>					<input type="checkbox"/>

Now compile, send the project and go online with the PLC.

Once online, press the glasses icon to update the status of the variables.

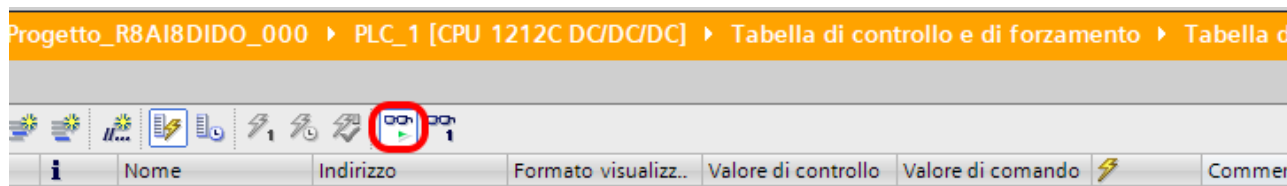

Under the "Control value" column you can read the I/O value in real time.

To control the outputs, it is necessary to enter "TRUE" or "FALSE" in the "Command value" column and then press the icon with the lightning bolt to order the writing. Note the status of the LED relating to the commanded output.

In the "Control value" column, the status of the outputs is also read in real time.

### 5.7. R-16DI-8DO-P I/O DATA

Define the PLC tags directly in the "standard tag table":

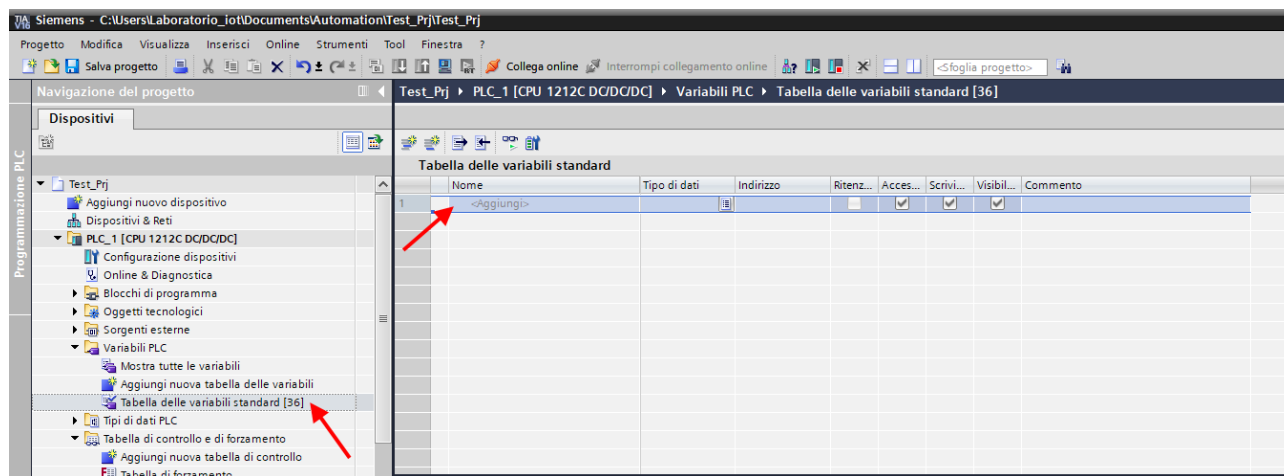

Add the tags related to the IO (in the example it is an R-16DI-8DO that is 16 digital inputs and 8 digital outputs). The addresses are written here:

Modulo	Telaio...	Posto ...	Indirizzo I	Indirizzo Q	Tipo	N° di articolo
r16di8do	0	0			R-16DI-8DO Ethernet...	R-16DI-8DO
PN-IO	0	0 X1			r16di8do	
16DI-8DO_1	0	1	1...2	1	16DI-8DO	

So bytes I1 and I2 contain the 16 inputs, byte Q1 the 8 outputs:

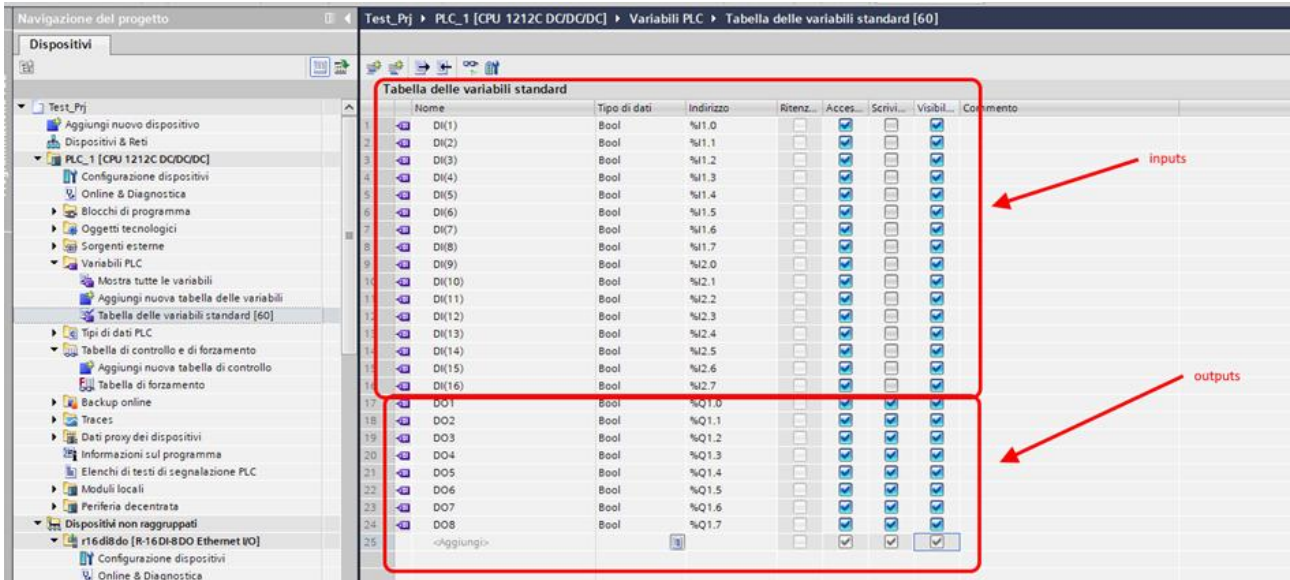

After this operation, define a new control table:

Click on "Add new control table" and then insert the variables

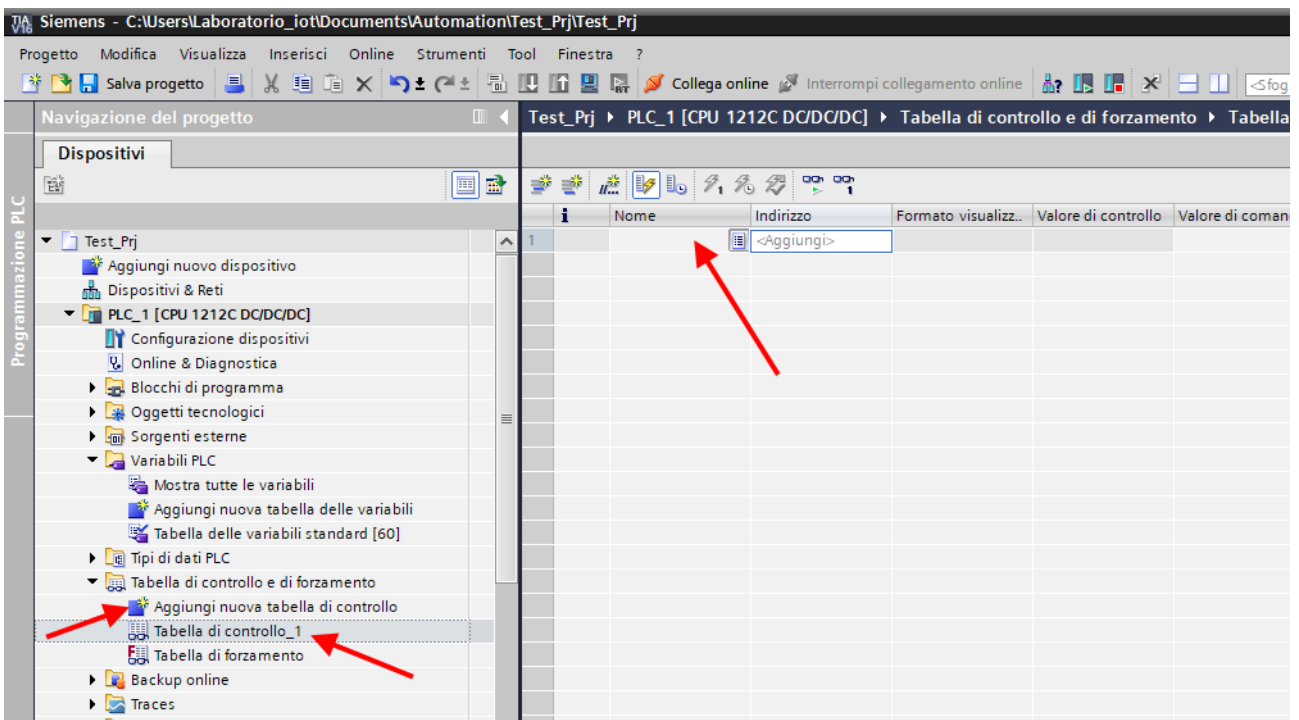



Since you have already defined them previously, just select the ones we want to monitor from the list:

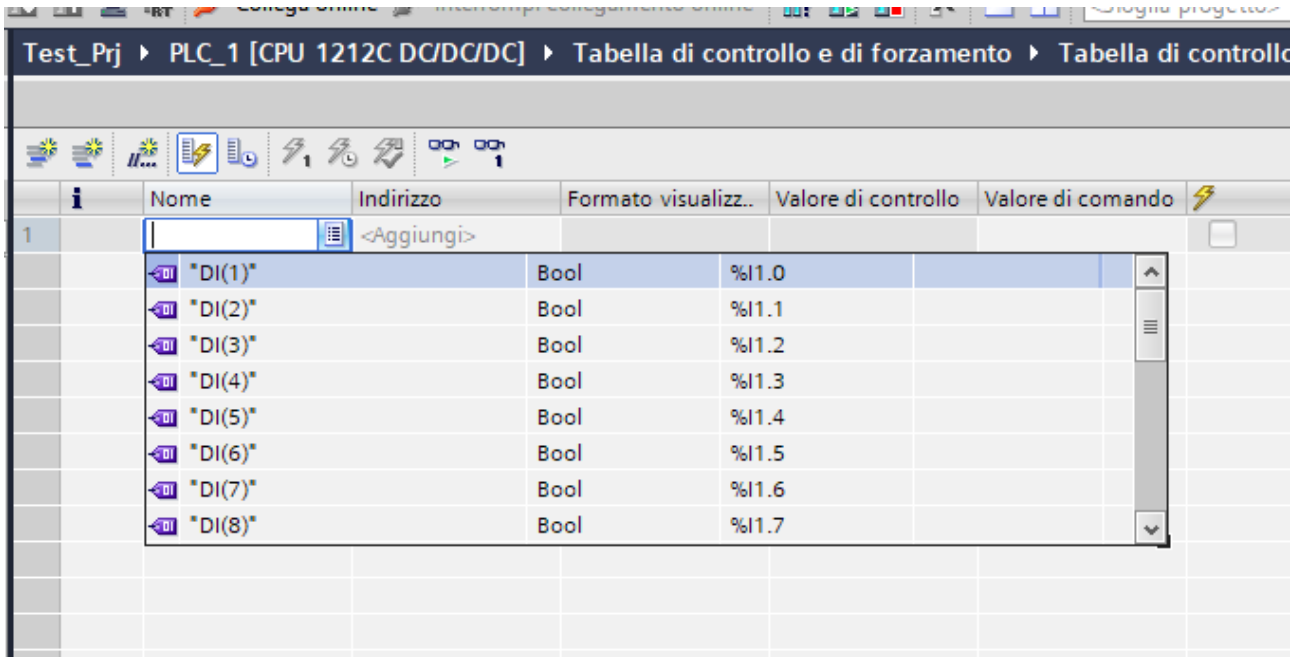

Once you have added all of them you will get:

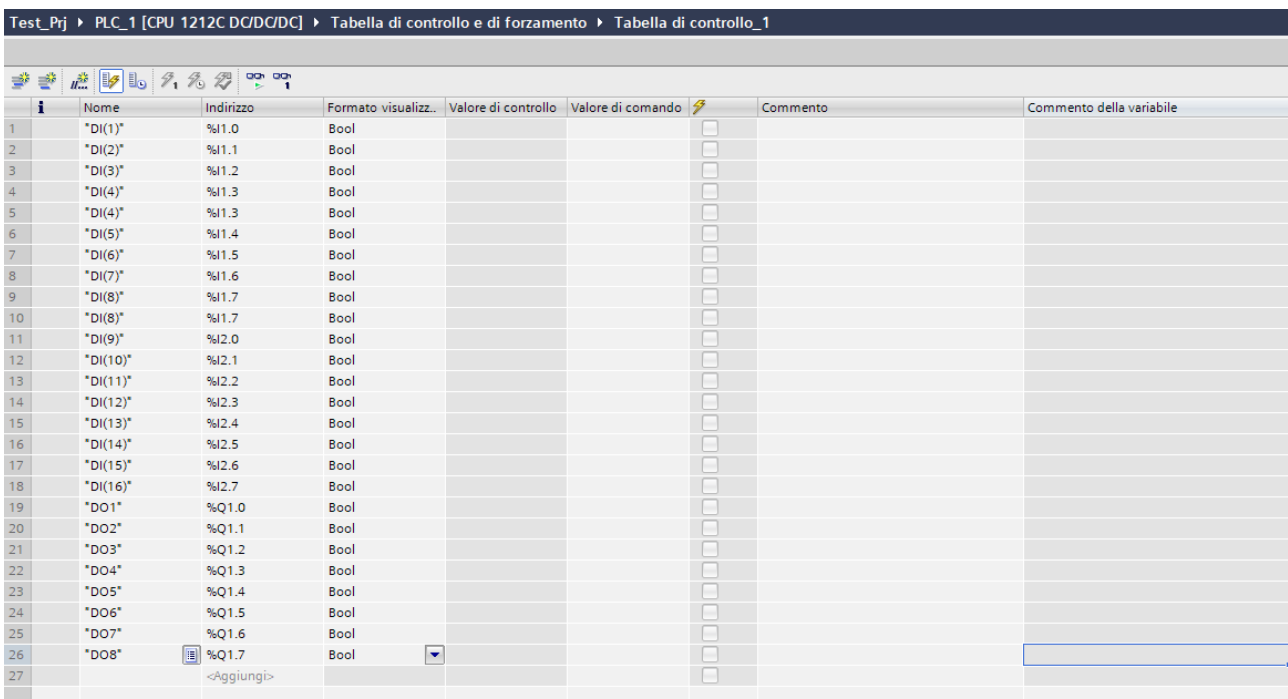

Now compile, send the project and go online with the PLC (all operations seen previously):  
Once online, press the glasses icon to update the status of the variables:

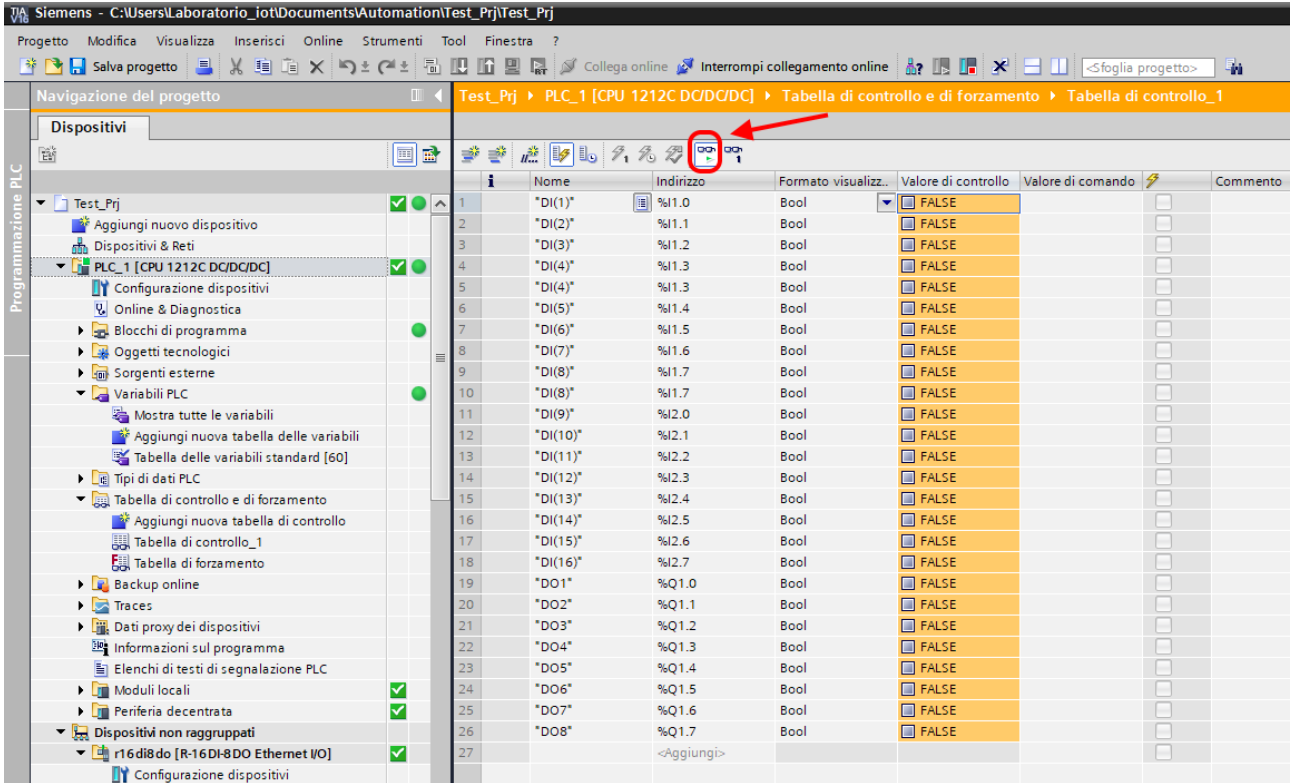

Under the "Control value" column you can read the I/O value in real time.

To control the outputs, it is necessary to enter "TRUE" in the "Command value" column and then press the icon with the lightning bolt to order the writing:

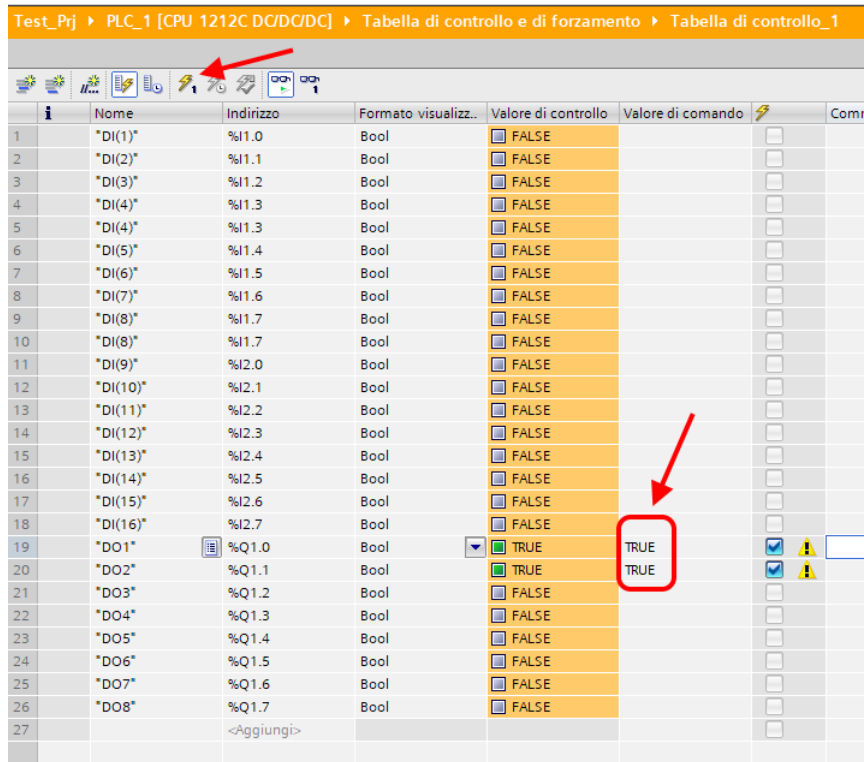

	Nome	Indirizzo	Formato visualizz..	Valore di controllo	Valore di comando	⚡	Comr
1	"DI(1)"	%I1.0	Bool	<input type="checkbox"/> FALSE		<input type="checkbox"/>	
2	"DI(2)"	%I1.1	Bool	<input type="checkbox"/> FALSE		<input type="checkbox"/>	
3	"DI(3)"	%I1.2	Bool	<input type="checkbox"/> FALSE		<input type="checkbox"/>	
4	"DI(4)"	%I1.3	Bool	<input type="checkbox"/> FALSE		<input type="checkbox"/>	
5	"DI(4)"	%I1.3	Bool	<input type="checkbox"/> FALSE		<input type="checkbox"/>	
6	"DI(5)"	%I1.4	Bool	<input type="checkbox"/> FALSE		<input type="checkbox"/>	
7	"DI(6)"	%I1.5	Bool	<input type="checkbox"/> FALSE		<input type="checkbox"/>	
8	"DI(7)"	%I1.6	Bool	<input type="checkbox"/> FALSE		<input type="checkbox"/>	
9	"DI(8)"	%I1.7	Bool	<input type="checkbox"/> FALSE		<input type="checkbox"/>	
10	"DI(8)"	%I1.7	Bool	<input type="checkbox"/> FALSE		<input type="checkbox"/>	
11	"DI(9)"	%I2.0	Bool	<input type="checkbox"/> FALSE		<input type="checkbox"/>	
12	"DI(10)"	%I2.1	Bool	<input type="checkbox"/> FALSE		<input type="checkbox"/>	
13	"DI(11)"	%I2.2	Bool	<input type="checkbox"/> FALSE		<input type="checkbox"/>	
14	"DI(12)"	%I2.3	Bool	<input type="checkbox"/> FALSE		<input type="checkbox"/>	
15	"DI(13)"	%I2.4	Bool	<input type="checkbox"/> FALSE		<input type="checkbox"/>	
16	"DI(14)"	%I2.5	Bool	<input type="checkbox"/> FALSE		<input type="checkbox"/>	
17	"DI(15)"	%I2.6	Bool	<input type="checkbox"/> FALSE		<input type="checkbox"/>	
18	"DI(16)"	%I2.7	Bool	<input type="checkbox"/> FALSE		<input type="checkbox"/>	
19	"DO1"	%Q1.0	Bool	<input checked="" type="checkbox"/> TRUE	TRUE	<input checked="" type="checkbox"/>	⚡
20	"DO2"	%Q1.1	Bool	<input checked="" type="checkbox"/> TRUE	TRUE	<input checked="" type="checkbox"/>	⚡
21	"DO3"	%Q1.2	Bool	<input type="checkbox"/> FALSE		<input type="checkbox"/>	
22	"DO4"	%Q1.3	Bool	<input type="checkbox"/> FALSE		<input type="checkbox"/>	
23	"DO5"	%Q1.4	Bool	<input type="checkbox"/> FALSE		<input type="checkbox"/>	
24	"DO6"	%Q1.5	Bool	<input type="checkbox"/> FALSE		<input type="checkbox"/>	
25	"DO7"	%Q1.6	Bool	<input type="checkbox"/> FALSE		<input type="checkbox"/>	
26	"DO8"	%Q1.7	Bool	<input type="checkbox"/> FALSE		<input type="checkbox"/>	
27		<Aggiungi>				<input type="checkbox"/>	

In the "Control value" column, the outputs are now correctly read to "True".

### 5.8. R-8AI-8DIDO-P I/O DATA

Define the PLC tags directly in the "standard tag table":

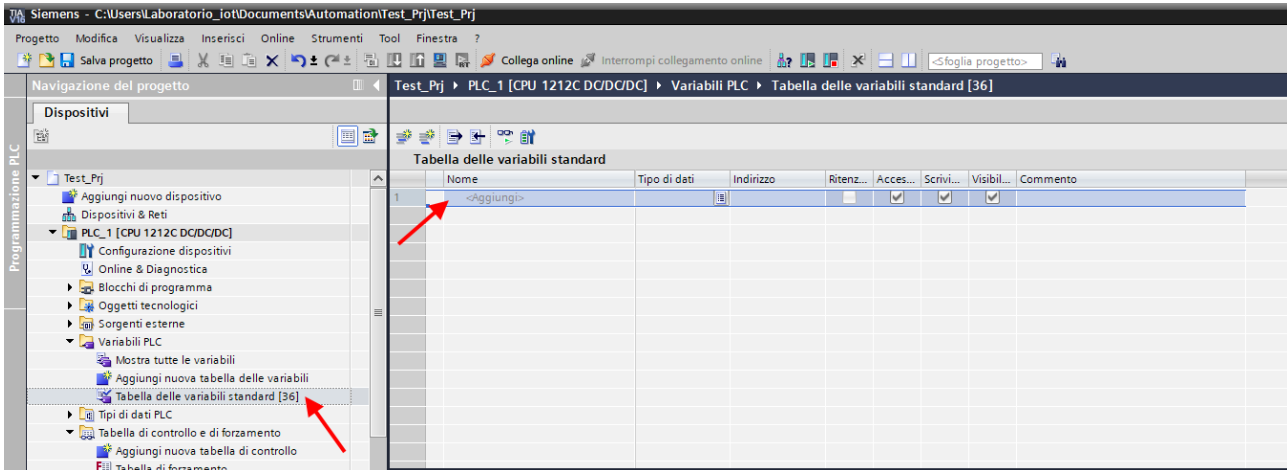

Let's now add the variables relating to the IO. For example the addresses are written here:

Vista generale dispositivi						
Modulo	Telaio...	Posto connettore	Indirizzo I	Indirizzo Q	Tipo	
▼ r8ai8didop	0	0			R-8AI-8DIDO-P Ethe...	
▶ PN-IO	0	0 X1			r8ai8didop	
8AIN Integer value_1	0	1	68...83		8AIN Integer value	
8DIDO_1	0	2	1	1	8DIDO	
8AIN_1	0	3	84...115		8AIN	
AIN Burn State_1	0	4	2		AIN Burn State	

So byte I1 contains the 8 digital inputs (those as inputs), byte Q1 the 8 outputs (those configured as outputs). Bytes from I68 to I83 show the values of the 8 analog inputs (2 bytes per input). Bytes from I84 to I15 show the values of the 8 analog inputs floating point (4 bytes per input). Byte I2 shows the burnout status of the analog inputs configured by thermocouple.

Below is the default mapping of the available digital IOs:

<i>INPUT/OUTPUT</i>	<i>DEFAULT ADDRESS IO CONFIGURED AS AN INPUT</i>	<i>DEFAULT ADDRESS IO CONFIGURED AS AN OUTPUT</i>
IO1	I1.0	Q1.0
IO2	I1.1	Q1.1
IO3	I1.2	Q1.2
IO4	I1.3	Q1.3
IO5	I1.4	Q1.4
IO6	I1.5	Q1.5
IO7	I1.6	Q1.6
IO8	I1.7	Q1.7

The default mapping of the analog IOs is as follows:

<i>INTEGER ANALOG INPUT</i>	<i>DEFAULT ADDRESS INPUT</i>
AIN1	IW2
AIN 2	IW4
AIN 3	IW6
AIN 4	IW8
AIN 5	IW10
AIN 6	IW12
AIN 7	IW14
AIN 8	IW16

<i>FLOATING POINT ANALOG INPUT</i>	<i>DEFAULT ADDRESS INPUT</i>
AIN1	ID18
AIN 2	ID22
AIN 3	ID26
AIN 4	ID30
AIN 5	ID34
AIN 6	ID38
AIN 7	ID42
AIN 8	ID44

## 5.9. R-SG3-P I/O DATA

Define the PLC tags directly in the "standard tag table":

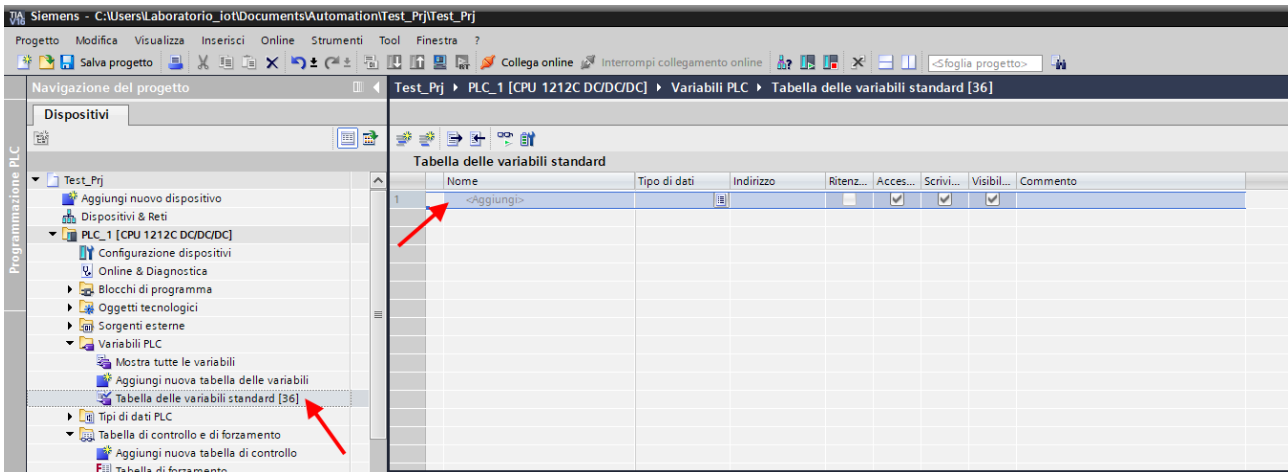

Let's now add the variables relating to the IO.

### **ATTENTION!**

**FROM FIRMWARE REVISION 1005 THE DEVICE PARAMETERS CAN ALSO BE CONFIGURED IN REAL TIME FROM THE PLC BY OVERWRITING THE INITIAL CONFIGURATION.**

For instance, by default you have:



Therefore, the Weight slot (integer) is created by default:

**SLOT “WEIGHT (INTEGER)”**

This slot contains only write variables:

<b>SLOT WEIGHT (INTEGER)</b>	<b>OFFSET (BYTE)</b>	<b>DATA TYPE</b>	<b>Read/Write</b>	<b>Notes</b>
NET WEIGHT	0-1-2-3	4 Byte Signed Integer	Read	Net Weight in integer format
GROSS WEIGHT	4-5-6-7	4 Byte Signed Integer	Read	Gross Weight in integer format
TARE WEIGHT	8-9-10-11	4 Byte Signed Integer	Read	Tare Weight in integer format
NUM. PIECES	12-13	2 Byte Unsigned Integer	Read	Pieces count number
ADC RAW	14-15-16-17	4 Byte unsigned Integer	Read	24 Bit ADC RAW

**SLOT DIN/DOUT**

The DIN/DOUT slot contains the digital variables relating to the DIN1 and DIN2 inputs (read) and the DOUT1 and DOUT2 variables (write) relating to the outputs.

Attention! It is only possible to configure a digital channel as DIN or DOUT:

<b>SLOT DIN/DOUT</b>	<b>OFFSET (BYTE)</b>	<b>DATA TYPE</b>	<b>Read/Write</b>	<b>Values</b>
DIN1	0.0	BIT	READ	Digital Input 1 value
DIN2	0.1	BIT	READ	Digital Input 2 value

<b>SLOT DIN/DOUT</b>	<b>OFFSET (BYTE)</b>	<b>DATA TYPE</b>	<b>Read/Write</b>	<b>Values</b>
DOUT1	0.0	BIT	WRITE	Digital Out 1 value
DOUT2	0.1	BIT	WRITE	Digital Out 2 value

The following optional slots can also be added:

**Slot Analog Input Configuration**

These are variables used to modify the weight measurement configuration parameters in real time:

<b>SLOT ANALOG INPUT CONFIGURATION</b>	<b>OFFSET (BYTE)</b>	<b>DATA TYPE</b>	<b>Read/Write</b>	<b>Values</b>
FUNCTION MODE	0	1 Byte Unsigned	Write	"0" = Factory Calibration "1" = Calibration with standard weight
MEASURE TYPE	1	1 Byte Unsigned	Write	"0" = Compression and traction (Bipolar) "1" = Balance (Unipolar)
MEASURE UNIT	2	1 Byte Unsigned	Write	0 = Kg 1 = g 2 = t 3 = lb 4 = l 5 = N 6 = bar 7 = atm 8 = other
CELL SENSIBILITY	3-4-5-6	4 Byte Floating Point	Write	Cell Sensibility in [mV/V]
CELL FULLSCALE	7-8-9-10	4 Byte Floating Point	Write	Cell Full Scale
STANDARD WEIGHT VALUE	11-12-13-14	4 Byte Floating Point	Write	Standard Weight value
NOISE FILTER	15	1 Byte Unsigned	Write	"0" = disable "1" = enable
FILTER LEVEL	16	1 Byte Unsigned	Write	"0".."6" = Filter Level "7" = Advanced
ADC SPEED	17	1 Byte Unsigned	Write	"0" = 960 Hz "1" = 300 Hz "2" = 150 Hz "3" = 100 Hz "4" = 60 Hz



				"5" = 12 Hz "6" = 4.7 Hz
NOISE VARIATION	18-19-20-21	4 Byte Floating Point	Write	ADC Points variation
FILTER RESPONSE SPEED	22-23-24-25	4 Byte Floating Point	Write	"0.01" = Max Slow Response "1" = Max Fast Response
NET WEIGHT RESOLUTION	26	1 Byte Unsigned	Write	"0" = Automatic "1" = Manual "2" = Maximum
MANUAL RESOLUTION	27-28-29-30	4 Byte Floating Point	Write	Manual Resolution Value
SAMPLE PIECE WEIGHT	31-32-33-34	4 Byte Floating Point	Write	Single Piece Weight
AUTOMATIC TARE TRACKER	35	1 Byte Unsigned	Write	"0" = disable "1" = enable
ADC VALUE	36-37-38-39	4 Byte Unsigned Integer	Write	Tracker ADC Value
DELTA WEIGHT	40-41-42-43	4 Byte Floating Point	Write	Stable condition Delta Weight
DELTA TIME	44-45	2 Byte Unsigned Integer	Write	Stable condition Delta Time [x100ms]

<b>SLOT ANALOG INPUT CONFIGURATION</b>	<b>OFFSET (BYTE)</b>	<b>DATA TYPE</b>	<b>Read/Write</b>	<b>Values</b>
CONFIGURATION APPLIED	0-1	2 Byte Unsigned Integer	Read	"0" = configuration on-going "1" = configuration applied

**SLOT Analog Output (NO EFFECT ON THE R-SG3-P MODEL)**

It is the variable related to the analog output in voltage/current, it accepts the value in uA or mV

<b>SLOT ANALOG OUTPUT</b>	<b>OFFSET (BYTE)</b>	<b>DATA TYPE</b>	<b>Read/Write</b>	<b>Values</b>
Analog Output	0-1	2 Byte Unsigned Integer	Write	Usable only if the parameter "ANALOG OUTPUT WORKING MODE" is configured in "Commandable from Profinet"  Output value in [mV] from 0 to 10500 or [uA] from 0 to 21000

**SLOT Analog Output Configuration (NO EFFECT ON THE R-SG3-P MODEL)**

These are variables used to modify the analog output configuration parameters in real time:

<b>SLOT ANALOG OUTPUT CONFIGURATION</b>	<b>OFFSET (BYTE)</b>	<b>DATA TYPE</b>	<b>Read/Write</b>	<b>Values</b>
ANALOG OUTPUT WORKING MODE	0	1 Byte Unsigned Integer	Write	"0" = Linked to Weight % "1" = Commandable from Profinet
ANALOG OUTPUT TYPE	1	1 Byte Unsigned Integer	Write	"0" = Output configured in voltage mode "1" = Output configured in current mode

<b>SLOT ANALOG OUTPUT CONFIGURATION</b>	<b>OFFSET (BYTE)</b>	<b>DATA TYPE</b>	<b>Read/Write</b>	<b>Values</b>
CONFIGURATION APPLIED	0-1	2 Byte Unsigned Integer	Read	"0" = configuration on-going "1" = configuration applied

### SLOT CMD

These are variables that allow you to send commands to the device and know the status of the command.

<b>SLOT ANALOG OUTPUT CONFIGURATION</b>	<b>OFFSET (BYTE)</b>	<b>DATA TYPE</b>	<b>Read/Write</b>	<b>Values</b>
COMMAND VALUE	0-1	2 Byte Unsigned Integer	Write	See Table below

<b>COMMAND (DECIMAL) Values</b>	<b>FUNCTION</b>
0	No Command
43948	Reboot the device
49594	Acquires the tare in RAM (at reboot is lost)
49914	Acquires the tare in Flash for the calibration procedure in both operating modes (factory calibration and with sample weight)
50700	Acquires the sample weight value in Flash for calibration with standard weight
50773	Acquires the tare value from the register MANUAL TARE (only for the factory calibration mode)
49151	Reset the maximum net weight
45056	Reset the minimum net weight

**Note that if you need to send the same command 2 or more times, you must first insert the "0" command because the command are executed on change.**

<b>SLOT ANALOG OUTPUT CONFIGURATION</b>	<b>OFFSET (BYTE)</b>	<b>DATA TYPE</b>	<b>Read/Write</b>	<b>Values</b>
COMMAND VALUE (STATUS)	0-1	2 Byte Unsigned Integer	Read	"0" Command executed ≠ "0" Command Pending

**SLOT DIAGN**

It contains the diagnostic variable

<b>SLOT DIAGNOSTIC</b>	<b>OFFSET (BYTE)</b>	<b>DATA TYPE</b>	<b>Read/Write</b>	<b>Values</b>
DIAGNOSTIC	0-1	2 Byte Unsigned Integer	Read	BIT 0 LSBIT Bit 0 = 1 THRESHOLD AND STABLE WEIGHT for DIDO 1  BIT 1 Bit 1 = 1 FULL SCALE CELL  BIT 2 (RO) Bit 2 = 1 NET WEIGHT < 0  BIT 3 (RO) Bit 3 = 1 THRESHOLD AND STABLE WEIGHT for DIDO 2  BIT 4 (RO) Bit 4 = 1 Stable weight  BIT 5-6 Not used  BIT 7 (RO) Bit 7 = 1 Threshold with hysteresis for DIDO 1  BIT 8 (RO) Bit 8 = 1 automatic tare tracker (if enabled)  BIT 9 (RO) Bit 9 = 1 Threshold with hysteresis for DIDO 2  BIT 10..15 Not used

**SLOT Digital I/O Configuration**

<b>SLOT DIGITAL I/O CONFIGURATION</b>	<b>OFFSET (BYTE)</b>	<b>DATA TYPE</b>	<b>Read/Write</b>	<b>Values</b>
DIGITAL 1 I/O MODE	0	1 Byte Unsigned	Write	"0" = Digital Input Mode "1" = Digital Output Mode
DIGITAL 1 INPUT FUNCTION	1	1 Byte Unsigned	Write	"0" = Acquire Tare "1" = Digital Input
DIGITAL 1 OUTPUT MODE	2	1 Byte Unsigned	Write	"0" = Normally Open "1" = Normally Close
DIGITAL 1 OUTPUT CONFIGURATION	3	1 Byte Unsigned	Write	"0" = Cell Full Scale "1" = Threshold and Stable Weight "2" = Stable Weight "3" = Commandable from Profinet "4" = Threshold with hysteresis
DIGITAL 1 I/O THRESHOLD OUTPUT	4-5-6-7	4 Byte Floating Point	Write	Threshold Value
DIGITAL 1 I/O HYSTERESIS OUTPUT	8-9-10-11	4 Byte Floating Point	Write	Hysteresis Value
DIGITAL 2 I/O MODE	12	1 Byte Unsigned	Write	"0" = Digital Input Mode "1" = Digital Output Mode
DIGITAL 2 I/O FUNCTION	13	1 Byte Unsigned	Write	"0" = Acquire Tare "1" = Digital Input
DIGITAL 2 I/O OUTPUT MODE	14	1 Byte Unsigned	Write	"0" = Normally Open "1" = Normally Close
DIGITAL 2 I/O OUTPUT CONFIGURATION	15	1 Byte Unsigned	Write	"0" = Cell Full Scale "1" = Threshold and Stable Weight "2" = Stable Weight "3" = Commandable from Profinet "4" = Threshold with hysteresis

DIGITAL 2 I/O THRESHOLD OUTPUT	16-17-18-19	4 Byte Floating Point	Write	Threshold Value
DIGITAL 2 I/O HYSTERESIS OUTPUT	20-21-22-23	4 Byte Floating Point	Write	Hysteresis Value

<b>SLOT DIGITAL I/O CONFIGURATION</b>	<b>OFFSET (BYTE)</b>	<b>DATA TYPE</b>	<b>Read/Write</b>	<b>Values</b>
CONFIGURATION APPLIED	0-1	2 Byte Unsigned Integer	Read	"0" = configuration on-going "1" = configuration applied

**SLOT WEIGHT (FLOAT)**

It shows the weight measurement variables in 32-bit floating point format.

<b>SLOT WEIGHT (FLOAT)</b>	<b>OFFSET (BYTE)</b>	<b>DATA TYPE</b>	<b>Read/Write</b>	<b>Notes</b>
NET WEIGHT	0-1-2-3	4 Byte Floating Point	Read	Net Weight in float format
GROSS WEIGHT	4-5-6-7	4 Byte Floating Point	Read	Gross Weight in float format
TARE WEIGHT	8-9-10-11	4 Byte Floating Point	Read	Tare Weight in float format
MAX Net Weight	12-13-14-15	4 Byte Floating Point	Read	Max Net Weight from reboot or reset command
MIN Net Weight	16-17-18-19	4 Byte Floating Point	Read	Min Net Weight from reboot or reset command

### 5.10. R- 4AO-8DIDO-P I/O DATA

Define the PLC tags directly in the "standard tag table":

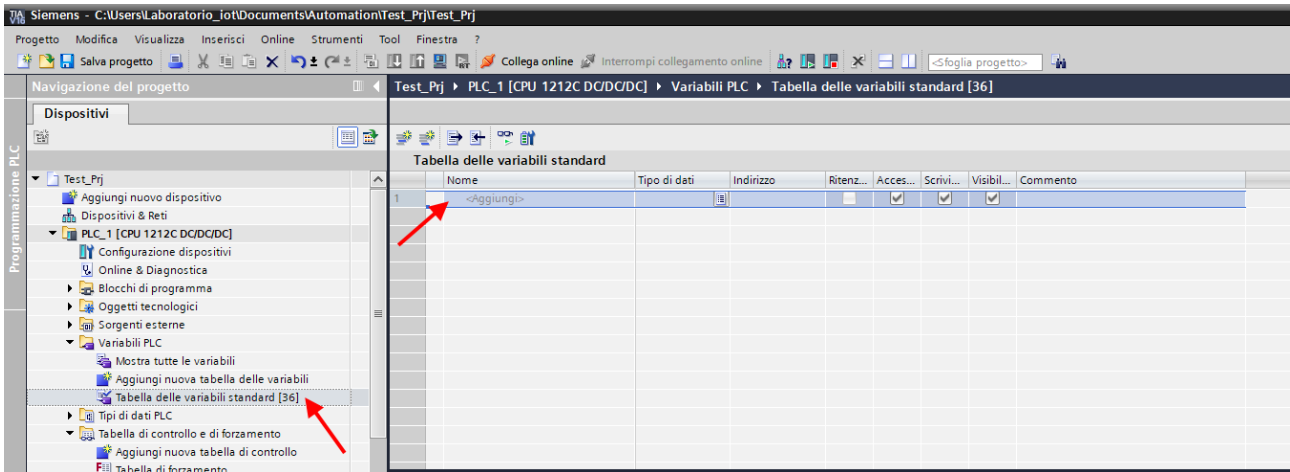

Let's now add the variables relating to the IO.  
For example the addresses are written here:

Vista generale dispositivi							
Modulo	Telaio...	Posto ...	Indirizzo I	Indirizzo Q	Tipo	N° di articolo	
▼ r4ao8didop	0	0			R-4AO-8DIDO-P Eth...	R-4AO-8DI..	
▶ PN-IO	0	0 X1			r4ao8didop		
4AO_1	0	1		64...71	4AO		
8DIDO_1	0	2	1	1	8DIDO		
AO Status_1	0	3	2...3		AO Status		
	0	4					

Bytes from Q64 to Q71 show the values of the 4 analog outputs in signed integer (2 bytes per output).  
byte I1 contains the 8 digital inputs (those configured as inputs), byte Q1 the 8 outputs (those configured as outputs).  
Bytes I2 and I3 show the status of the analog output.

### 4AO

Name	Data Type	Display as Bits
AO.1 Eng. Int. Value	Integer16	<input type="checkbox"/> No
AO.2 Eng. Int. Value	Integer16	<input type="checkbox"/> No
AO.3 Eng. Int. Value	Integer16	<input type="checkbox"/> No
AO.4 Eng. Int. Value	Integer16	<input type="checkbox"/> No

They represent the value to be driven of the analog output in engineering units. The data type is signed 16-bit integer.

### 8DIDO

Below is the default mapping of the available digital IOs:

<i>INPUT/OUTPUT</i>	<i>DEFAULT ADDRESS IO CONFIGURED AS AN INPUT</i>	<i>DEFAULT ADDRESS IO CONFIGURED AS AN OUTPUT</i>
I01	I1.0	Q1.0
I02	I1.1	Q1.1
I03	I1.2	Q1.2
I04	I1.3	Q1.3
I05	I1.4	Q1.4
I06	I1.5	Q1.5
I07	I1.6	Q1.6
I08	I1.7	Q1.7

### AO STATUS

Shows the status of the analog outputs:



Name	Data Type	Display as Bits
Analog Outputs Status	Unsigned16	Bit 0: AO.1 Under range Bit 1: AO.2 Under range Bit 2: AO.3 Under range Bit 3: AO.4 Under range Bit 4: AO.1 Over range Bit 5: AO.2 Over range Bit 6: AO.3 Over range Bit 7: AO.4 Over range Bit 8: AO.1 Watchdog Bit 9: AO.2 Watchdog Bit 10: AO.3 Watchdog Bit 11: AO.4 Watchdog Bit 12: Not used Bit 13: Not used Bit 14: Not used Bit 15: Not used

### 5.11. I/O R-4RTD-8DIDO-P DATA

Define the PLC tags directly in the "standard tag table":

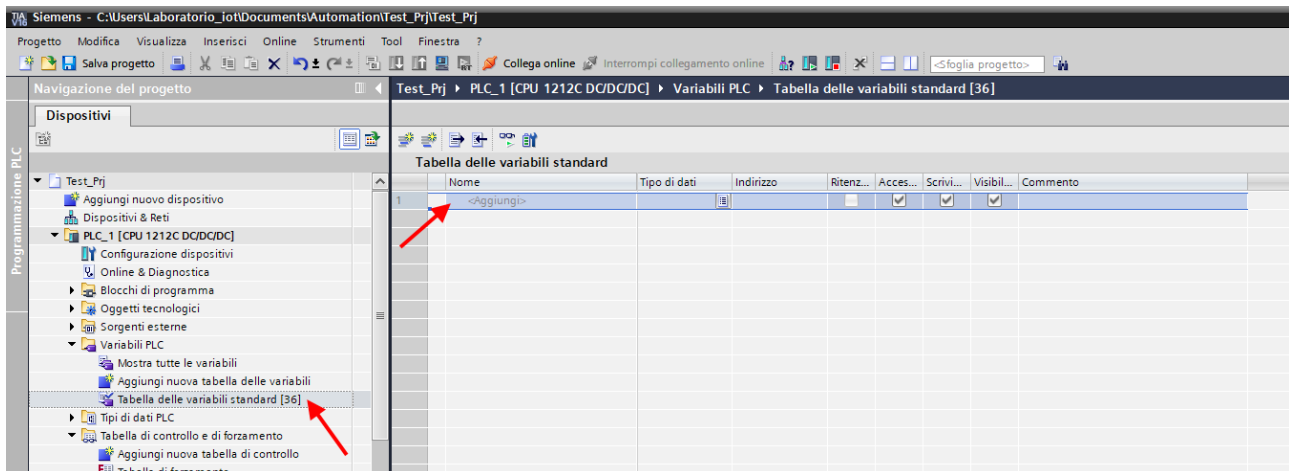

Let's now add the variables relating to the IO.  
 For example the addresses are written here:

Vista generale dispositivi						
Modulo	Telaio...	Posto ...	Indirizzo I	Indirizzo Q	Tipo	
▼ r4rtd8didop	0	0			R-4RTD-8DIDO-P Et...	
▶ PN-IO	0	0 X1			r4rtd8didop	
4RTD Integer value_1	0	1	68...75		4RTD Integer value	
8DIDO_1	0	2	1	1	8DIDO	
4RTD_1	0	3	76...91		4RTD	
RTD Burn State_1	0	4	2		RTD Burn State	

Bytes from I68 to I75 show the values of the 4 analog inputs (2 bytes per channel).

byte I1 contains the 8 digital inputs (those configured as inputs), byte Q1 the 8 outputs (those configured as outputs).

Bytes from I76 to I91 show the values of the 4 analog inputs in floating point format (4 bytes per channel).

Byte I2 shows the burn state of the inputs.

### RTD INT

Name	Data Type	Display as Bits
RTD.1 INT. VALUE	Integer16	<input type="checkbox"/> No
RTD.2 INT. VALUE	Integer16	<input type="checkbox"/> No
RTD.3 INT. VALUE	Integer16	<input type="checkbox"/> No
RTD.4 INT. VALUE	Integer16	<input type="checkbox"/> No

They represent the value of the analog measurement in engineering units. The data type is signed 16-bit integer.

### RTD FLOAT

Name	Data Type	Display as Bits
RTD.1 ENG. VALUE	Float32	<input type="checkbox"/> No
RTD.2 ENG. VALUE	Float32	<input type="checkbox"/> No
RTD.3 ENG. VALUE	Float32	<input type="checkbox"/> No
RTD.4 ENG. VALUE	Float32	<input type="checkbox"/> No

They represent the value of the analog measurement in engineering units. The data type is 32-bit float.

### 8DIDO

Below is the default mapping of the available digital IOs:

<i>INPUT/OUTPUT</i>	<i>DEFAULT ADDRESS IO CONFIGURED AS AN INPUT</i>	<i>DEFAULT ADDRESS IO CONFIGURED AS AN OUTPUT</i>
IO1	I1.0	Q1.0
IO2	I1.1	Q1.1
IO3	I1.2	Q1.2
IO4	I1.3	Q1.3
IO5	I1.4	Q1.4
IO6	I1.5	Q1.5
IO7	I1.6	Q1.6
IO8	I1.7	Q1.7

### BURN AND OVERRANGE STATUS

<b>Name</b>	<b>Data Type</b>	<b>Display as Bits</b>
<b>RTD BURN AND OVERRANGE STATUS BIT</b>	Unsigned8	Bit 0: RTD.1 OVERRANGE Bit 1: RTD.2 OVERRANGE Bit 2: RTD.3 OVERRANGE Bit 3: RTD.4 OVERRANGE Bit 4: RTD.1 BURN Bit 5: RTD.2 BURN Bit 6: RTD.3 BURN Bit 7: RTD.4 BURN

It shows the burn and overrange status of the channels.

### 5.12. COMPILATION AND SENDING OF THE PROJECT TO THE SIEMENS PLC

Now that the devices are configured, all that remains is to compile and send the configuration to the PLC.

# ATTENTION!

**YOU MUST ALWAYS DO A FULL HARDWARE COMPILATION BEFORE SENDING A PROJECT TO THE DEVICE:**

Before sending the project to the PLC, you are asked to select the ethernet interface and start the search, in order to select the PLC and press "Load".

**Caricamento avanzato**

Nodi di accesso configurati di "PLC\_1"

Dispositivo	Tipo di dispositivo	Posto c...	Tipo di interfa...	Indirizzo	Sottorete
PLC_1	CPU 1212C DC/D...	1 X1	PN/IE	192.168.90.44	PN/IE_1

Tipo di interfaccia PG/PC:

Interfaccia PG/PC:

Collegamento con l'interfaccia/la sottorete:

1° gateway:

Selezionare il sistema di destinazione:

Dispositivo	Tipo di dispositivo	Tipo di interfaccia	Indirizzo	Dispositivo di des...
plc_1	S7-1200	PN/IE	192.168.90.44	--
--	--	PN/IE	Indirizzo di accesso	--

LED lampeggia

Avvia ricerca

Carica    Annulla

Informazioni sullo stato online:  Visualizza solo messaggi di errore

- ⚠ Dispositivo accessibile trovato r16di8do
- ℹ Ricerca terminata. Sono stati trovati 1 nodi compatibili su 3 nodi accessibili.
- ❓ Richiamo informazioni sui dispositivi in corso...
- ✖ Scansione e richiesta informazioni concluse. È stato rilevato 1 problema.

Once the project has been sent, RUN the PLC:

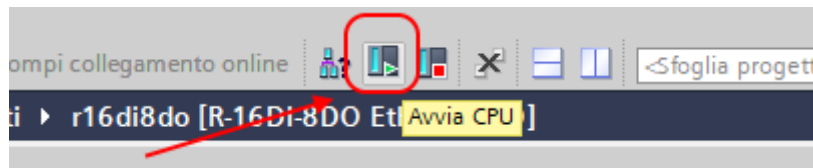

And go On-Line so as to check if there are any errors:

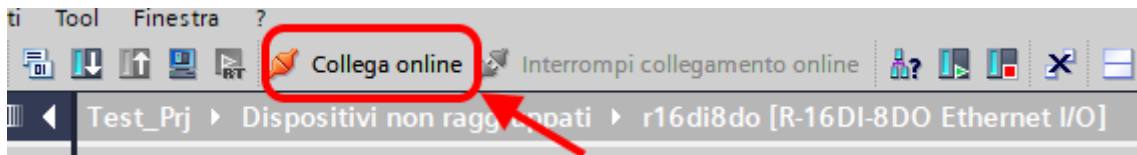

If everything is correct you will get a green icon next to the Seneca device:

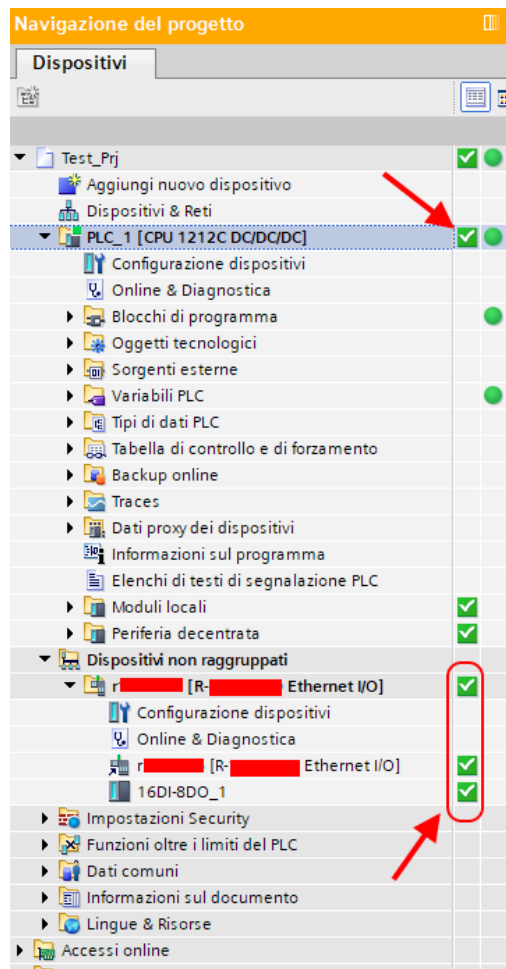

## 6. EXAMPLE OF CREATING A PROJECT WITH PLC CODESYS 3.5

Create a new standard project:

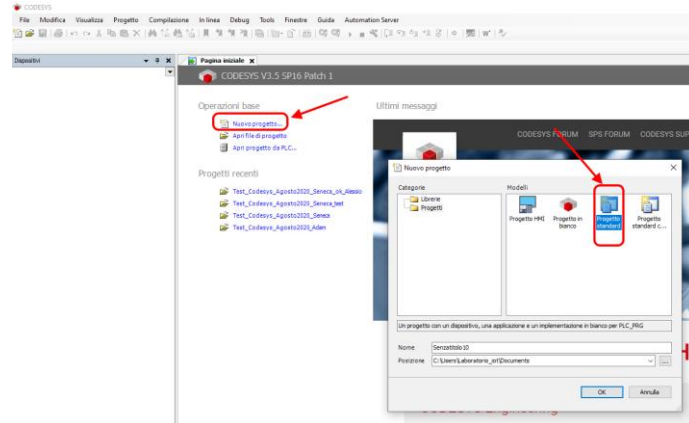

### 6.1.1. INSERTION OF THE CODESYS PLC IN THE PROJECT

Configure the PLC by selecting it in the tree on the left and then browsing the network:

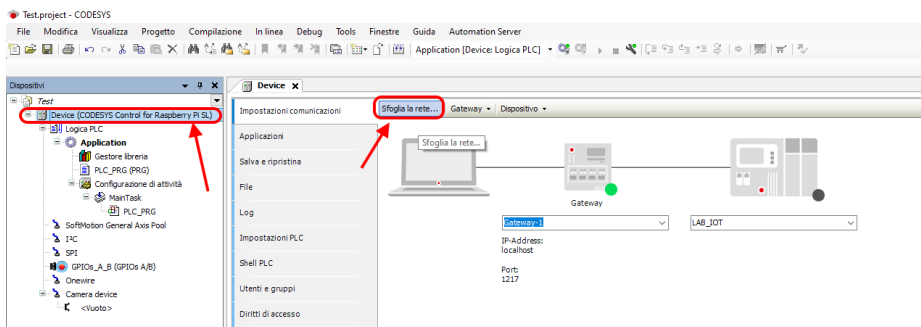

Select the PLC after scanning the network:

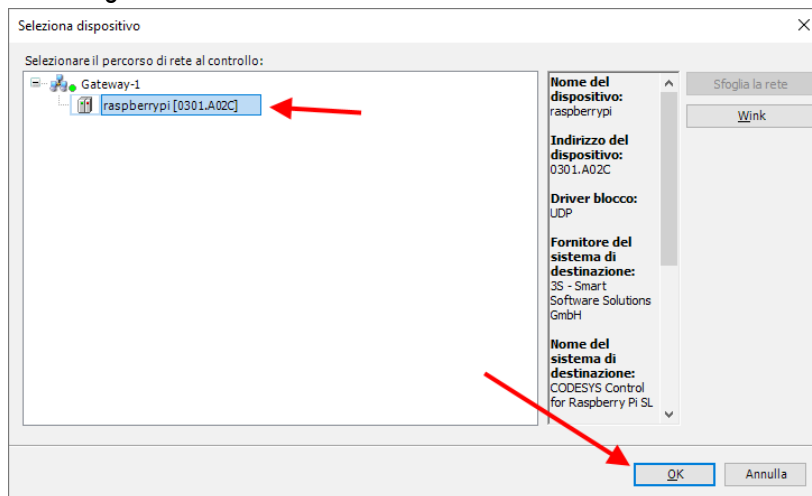

The PLC is now connected to the system:

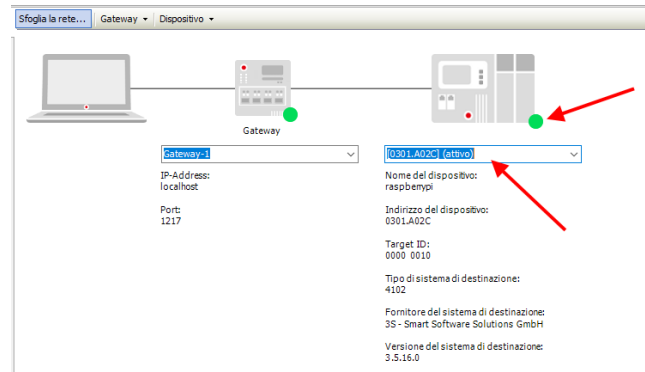

Now that the PLC has been detected, move on to insert a Profinet port on standard Ethernet:  
 Right click on device and "add device":

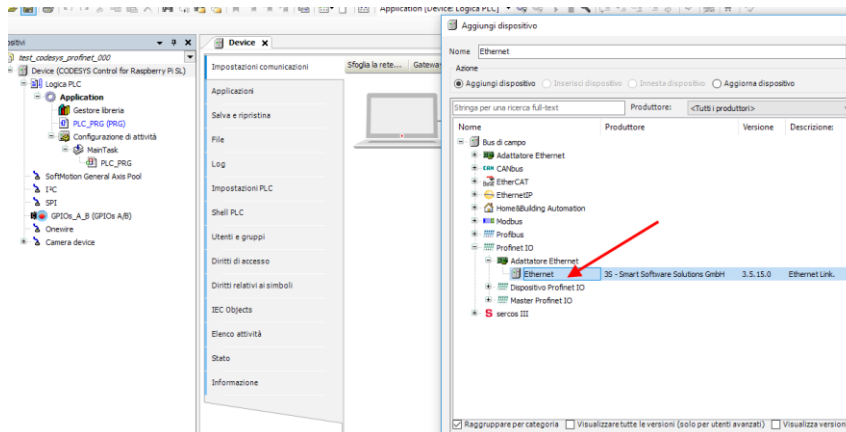

Then add the Profinet IO Master:

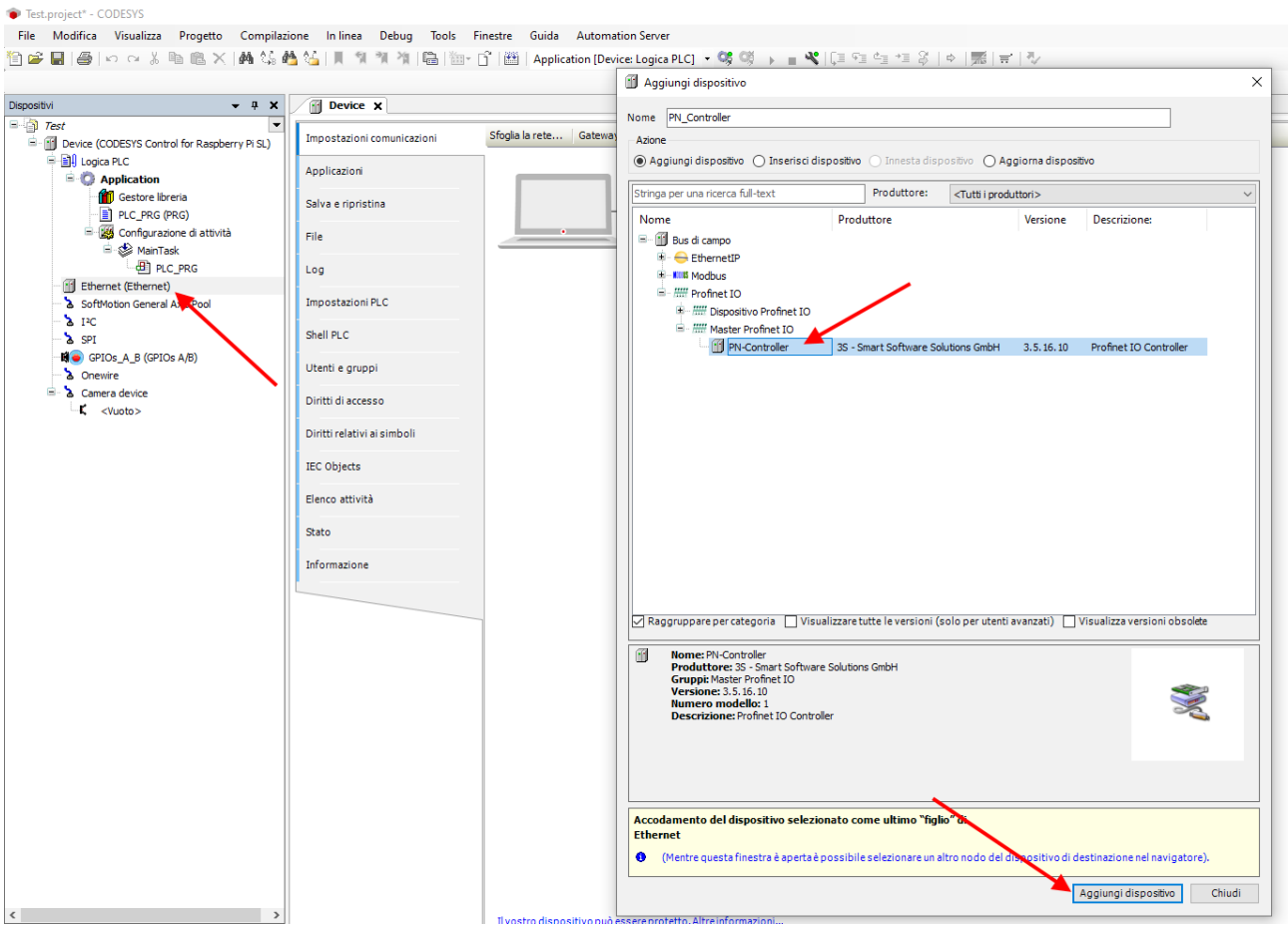

Double click on Ethernet, set the Ethernet port and the IP address of the PLC (in this case use 192.168.90.44):

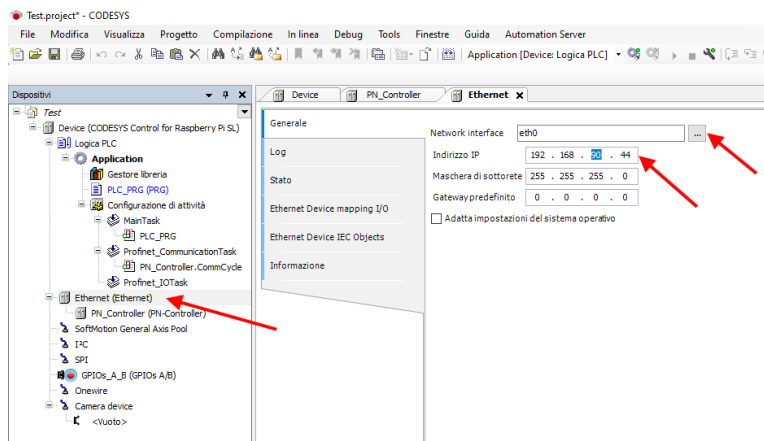



Set also the address range for the Profinet peripheral, double click on PN\_Controller:

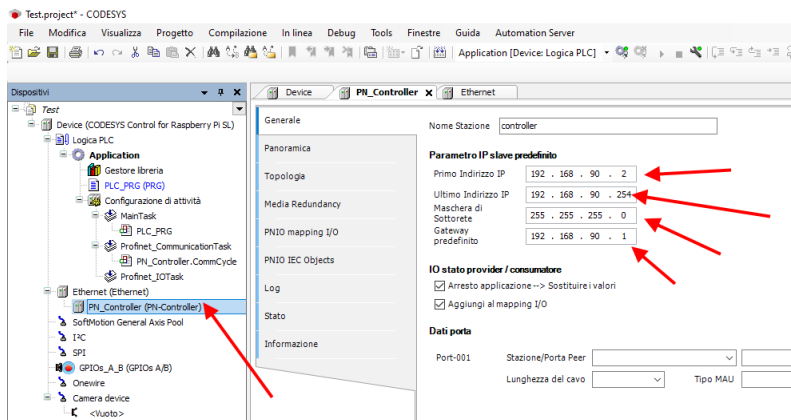

### 6.1.2. INSTALLING THE GSD

Now you need to connect the Seneca slave device PROFINET IO to the profinet master (controller).

First install the GSD file of the Seneca IO.

Select Tools->Device Repository:

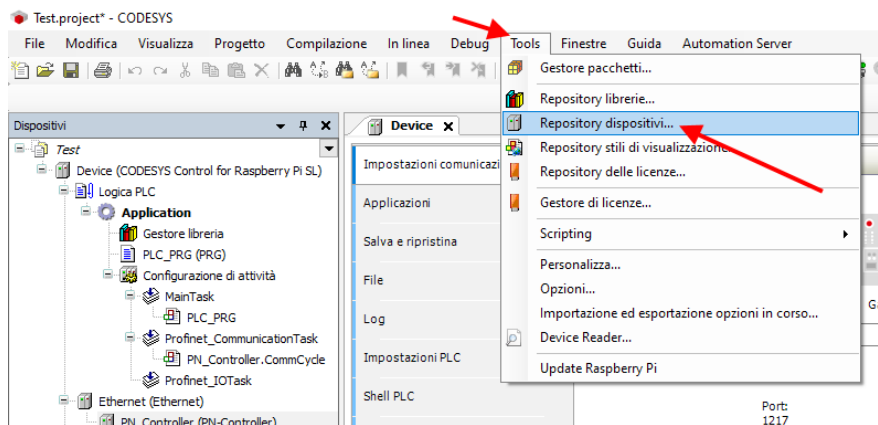

Now import the GSD file by selecting Profinet IO Slave and then Install:

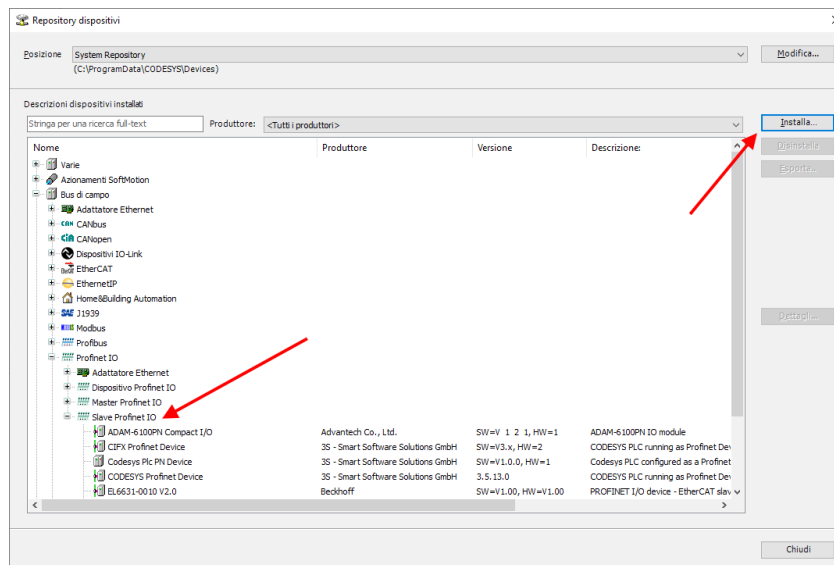

Now point to the correct folder and press OK.  
Codesys has now added the GSD file correctly.

At this point you can scan the network in search of Slave devices (Device).

First compile the project and log in to the PLC:

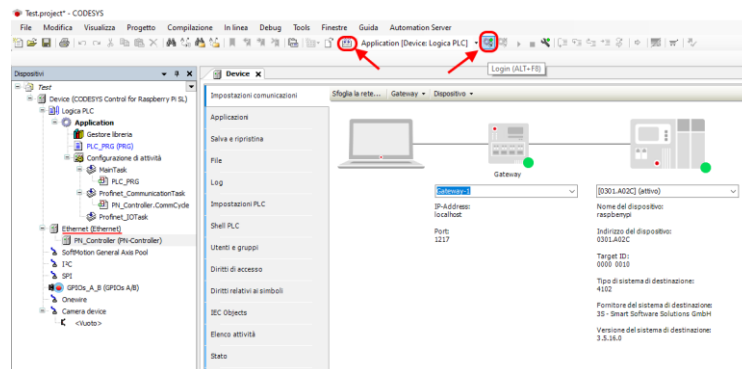

### 6.1.3. INSTALLATION OF THE SENECA PROFINET IO

Now that you are connected to the PLC, run the scan to find the devices:

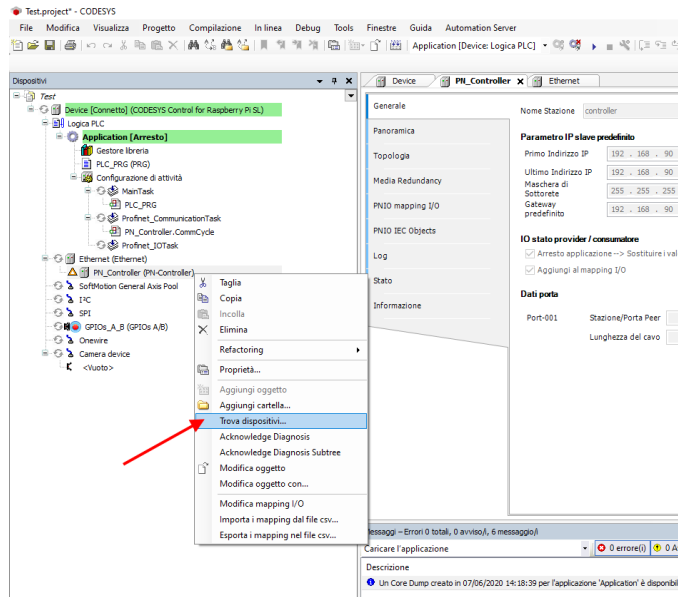

In the list of devices, select the Seneca IO and then "Copy to project":

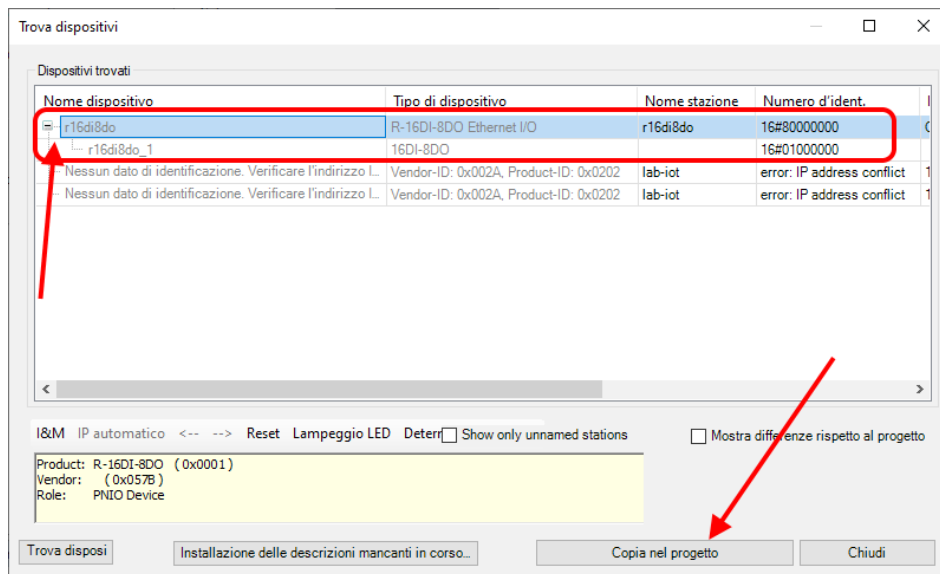

At this point you have added the device to the project:

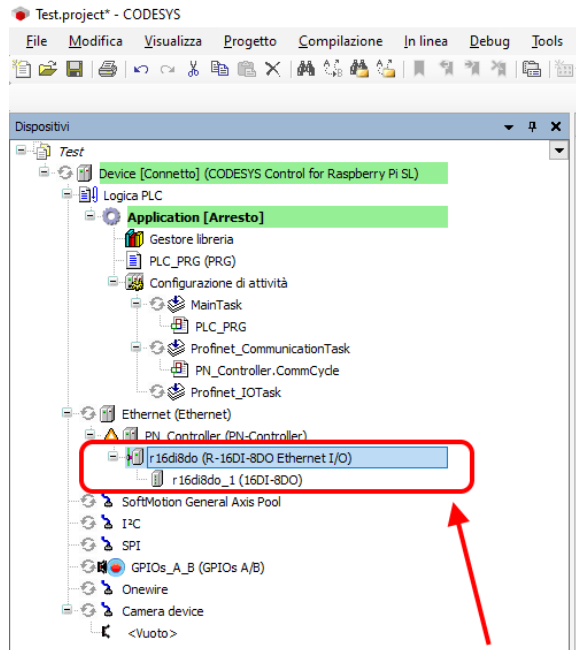

### 6.1.4. CONFIGURATION OF THE PARAMETERS OF THE SENECA IO

If you want to change the IO configuration parameters, you can set them from here:

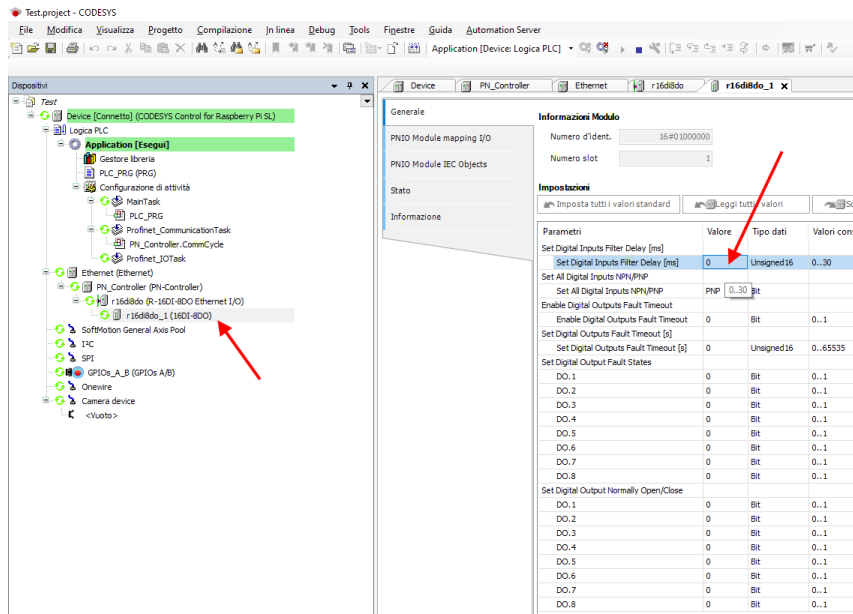

Check that everything is correct by compiling and running the PLC.

The PLC (Raspberry-pi) is quite slow and not real time, consequently it cannot manage the profinet at maximum speed so we modify the values by setting safety parameters:

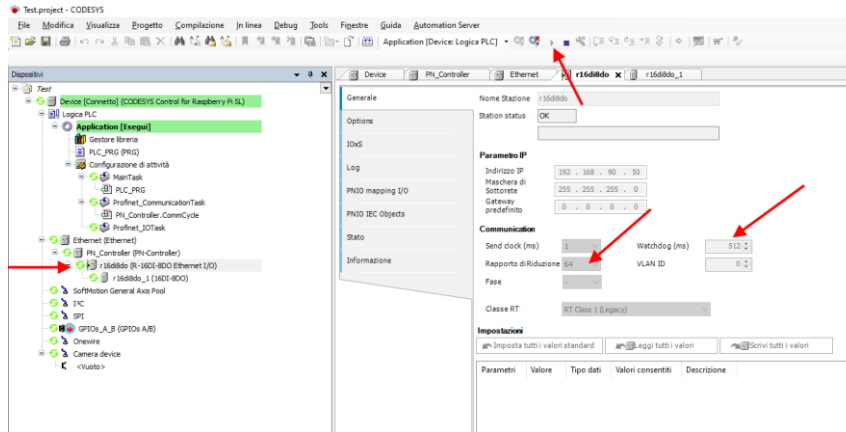

### 6.1.5. READING AND WRITING THE SENECA IO FROM CODESYS

Now see how it is possible to read and write IO on the Seneca device.

To write and read the status of the IO you have to insert a few code lines under PRG.

In the program, read the inputs from the %IW2 address and write in the %QB0 address as it is obtained from here:

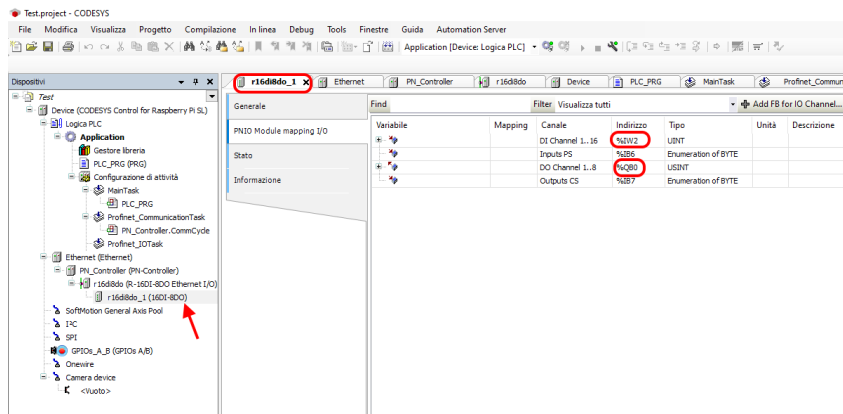

Declare an 8-bit (Word) variable for the 16 inputs and one byte for the 8 outputs.

In the program, instead, read the inputs from %IW2 and write the outputs on %QB0:

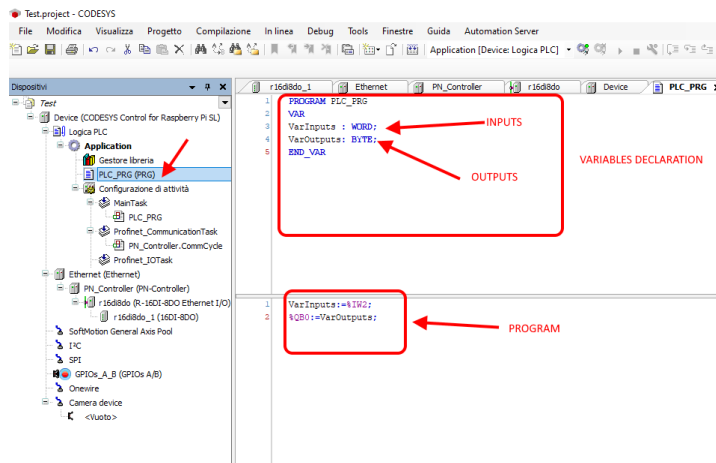

Go into login and start.

The value of the inputs can be read here:

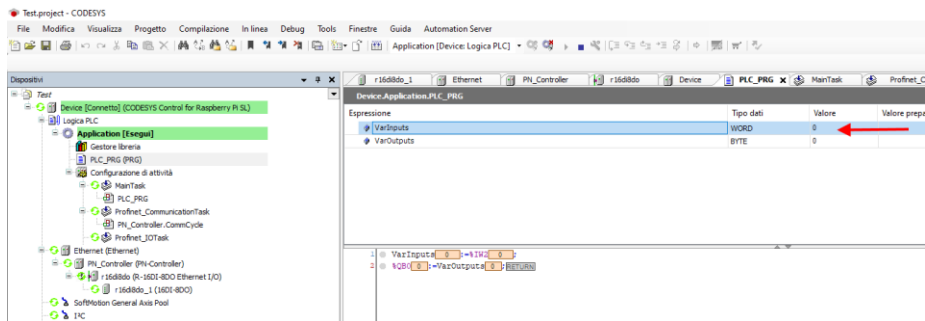

while to write the outputs you just set the byte value in the "prepared value" column, for example by writing 255 decimal = 11111111 binary all the outputs will be brought to 1:

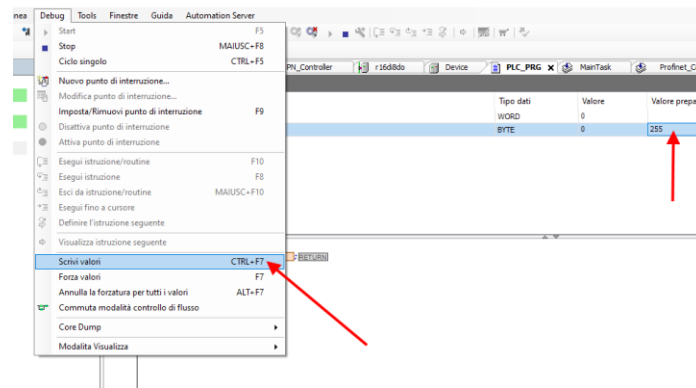

And then with "Write values" all the outputs are activated correctly.

## 7. CABLE HARNESS FOR MODELS WITH DOUBLE ETHERNET PORT

Models with double Ethernet port can be connected in daisy chain and take advantage of the Lan Fault Bypass.

### 7.1. CHAIN ETHERNET CONNECTION (DAISY CHAIN)

Using the daisy chain connection it is not necessary to use switches to connect the devices. An example (in this case on R-16DI-8DO-P) of connection of 3 devices is as follows:

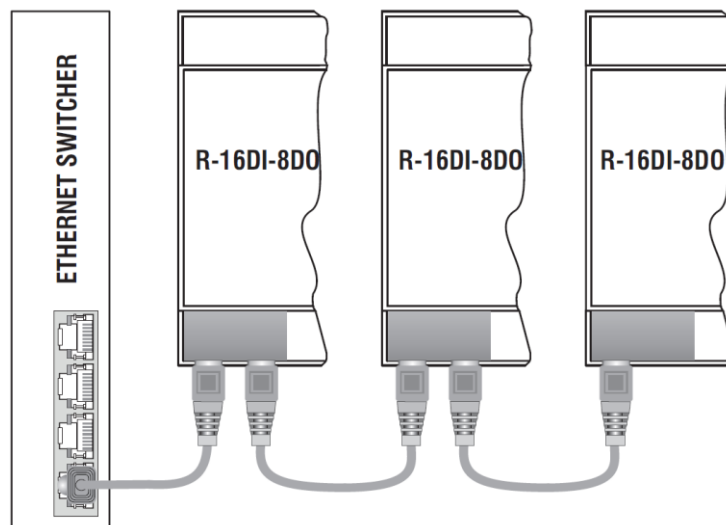

**! ATTENTION!**

**IT IS NOT POSSIBLE CREATE LOOPS WITH ETHERNET CABLES**



If it is necessary to connect the devices to the switches, correct wiring is as follows:

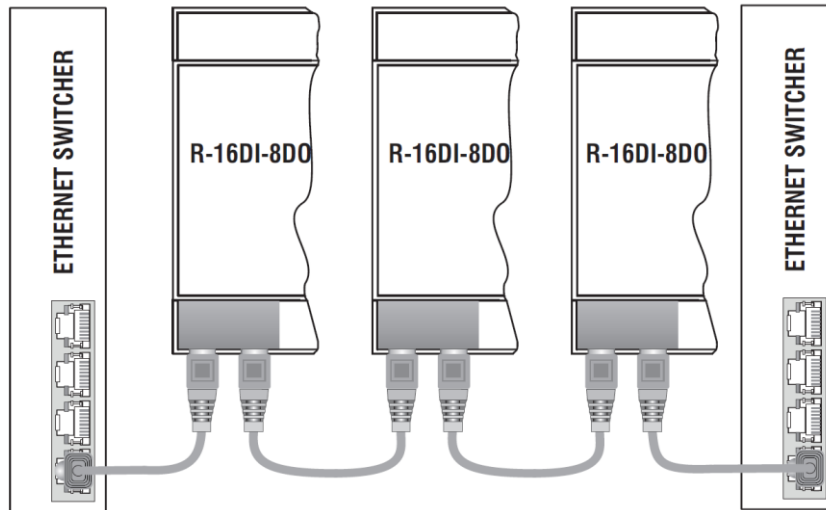

In the Ethernet wiring there must be no loop, otherwise the communication will not work, some examples of incorrect wiring are the following:

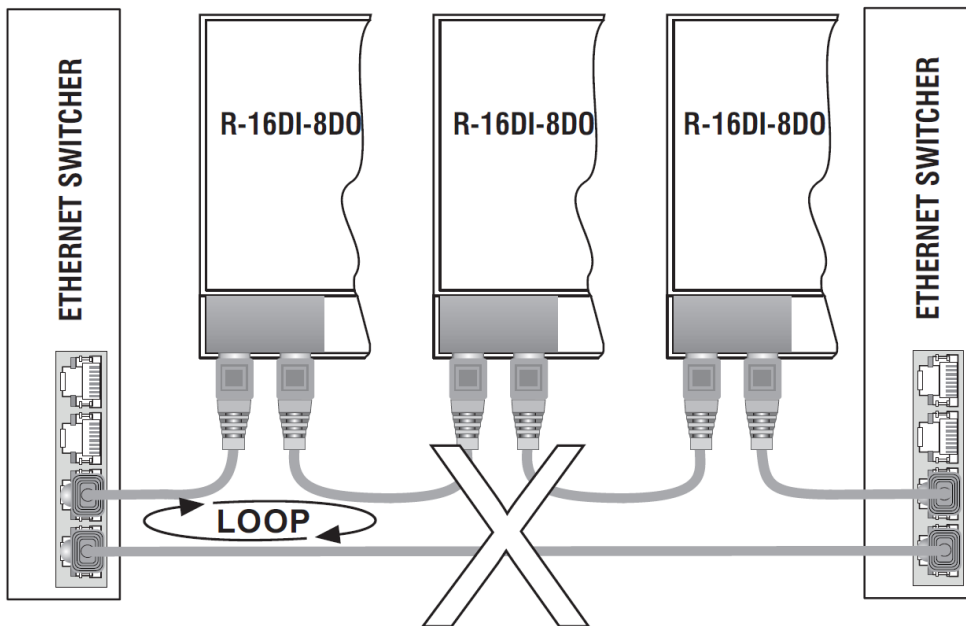

## 7.2. LAN FAULT-BYPASS FUNCTION

The LAN fault-bypass function allows you to keep the connection between the two Ethernet ports of the device ON, in the event of power failure problems.

If a device turns off, the chain is not interrupted and the devices downstream of the switched-off one will still be accessible.

This function has a limited duration: the connection remains active for a few days, typically 4.

The Lan fault-bypass function requires that the sum of the lengths of the two cables connected to the switched off module is less than 100m.

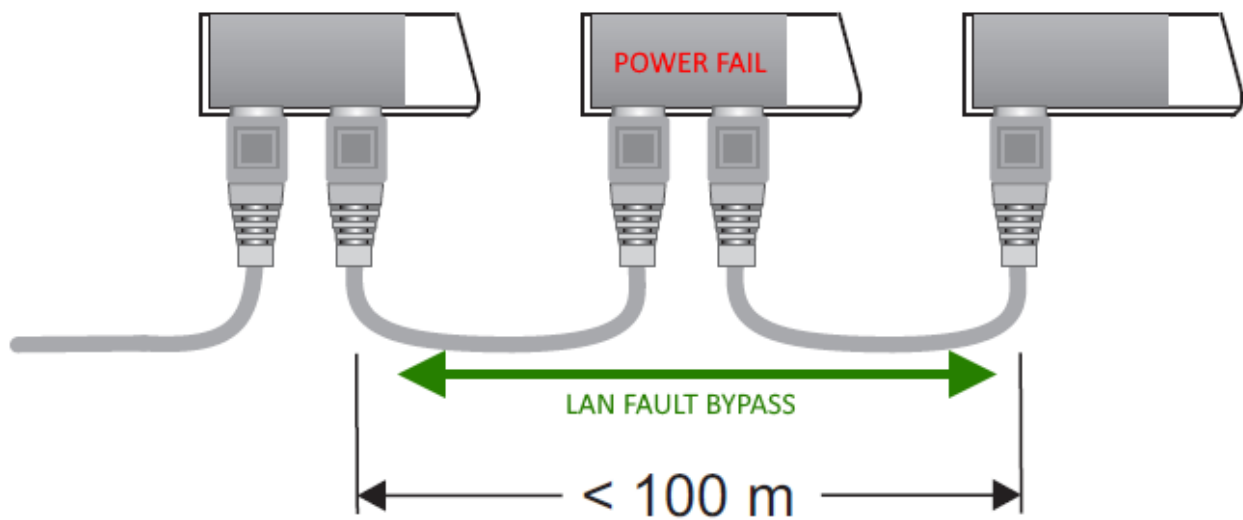

## 8. SEARCH AND MODIFICATION OF THE DEVICE IP WITH SENECA DISCOVERY TOOL

When in the R series device the STS LED is on steady, it is possible to obtain the IP address which has been set using the "Seneca Discovery" tool too.

The software can be downloaded from:

<https://www.seneca.it/en/linee-di-prodotto/software/easy/sdd>

Pressing the "search" button starts the search for all Seneca devices present in the network even if with IP addresses not compatible with the current PC configuration:



It is now possible to change the address by pressing the "Assign" button:

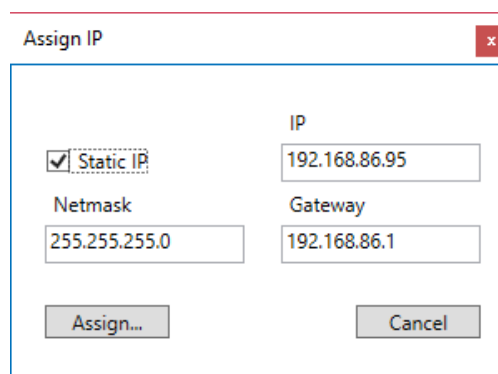

The software works on layer 2 level and it is therefore not necessary to have an Ethernet configuration compatible with the device you are looking for.

 **ATTENTION!**

**AS LONG AS THE STS LED IS FLASHING IT MEANS THE DEVICE HAS NOT SET AN IP ADDRESS. IN THIS SITUATION IT WILL NOT BE POSSIBLE TO SEARCH FOR THE DEVICE WITH THE SENECA DISCOVERY TOOL SOFTWARE**

## 9. FIRMWARE UPDATE

The firmware update can be performed via the web server in the appropriate section.

 **ATTENTION!**

**BEFORE ACCESSING THE WEB SERVER, DISCONNECT THE DEVICE FROM THE PROFINET NETWORK**

 **ATTENTION!**

**NOT TO DAMAGE THE DEVICE DO NOT REMOVE THE POWER SUPPLY DURING THE FIRMWARE UPDATE OPERATION.**

 **ATTENTION!**

**THE DEVICES ARE SUPPLIED BY THE FACTORY WITHOUT AN IP ADDRESS (0.0.0.0) IN THIS CASE THE "STS" LED FLASHES.**

**TO SET AN IP ADDRESS (FOR EXAMPLE TO ACCESS THE WEBSERVER OR TO CONNECT TO THE SENECA DISCOVERY DEVICE TOOL) USE THE PROFINET CONFIGURATION ENVIRONMENT OR FORCE THE ADDRESS 192.168.90.101 WITH THE APPROPRIATE DIP SWITCH**