

INSTALLATION MANUAL

Z-KEY series



PRELIMINARY WARNINGS

The word **WARNING** preceded by the symbol indicates conditions or actions that put the user's safety at risk. The word **ATTENTION** preceded by the symbol indicates conditions or actions that might damage the instrument or the connected equipment. The warranty shall become null and void in the event of improper use or tampering with the module or devices supplied by the manufacturer as necessary for its correct operation, and if the instructions contained in this manual are not followed.

	WARNING: The full content of this manual must be read before any operation. The module must only be used by qualified electricians. Specific documentation is available via QR-CODE shown on page 1.
	The module must be repaired and damaged parts replaced by the Manufacturer. The product is sensitive to electrostatic discharges. Take appropriate measures during any operation.
	Electrical and electronic waste disposal (applicable in the European Union and other countries with recycling). The symbol on the product or its packaging shows the product must be surrendered to a collection centre authorized to recycle electrical and electronic waste.



DOCUMENTATION
Z-KEY



SENECA s.r.l.; Via Austria, 26 – 35127 – PADOVA – ITALY; Tel. +39.049.8705359 - Fax +39.049.8706287

CONTACT INFORMATION

Technical support	support@seneca.it	Product information	sales@seneca.it
-------------------	-------------------	---------------------	-----------------

This document is the property of SENECA srl. Copies and reproduction are prohibited unless authorised. The content of this document corresponds to the described products and technologies. Stated data may be modified or supplemented for technical and/or sales purposes.

REFERENCE PRODUCTS

Z-KEY-0 ModBUS version

Z-KEY-P with Profinet protocol

Z-KEY-I with IEC 61850 protocol

Z-KEY-U with OPC-UA protocol

Z-KEY-E with Ethernet/IP protocol

Z-KEY-C ModBUS to Cloud

MODULE LAYOUT

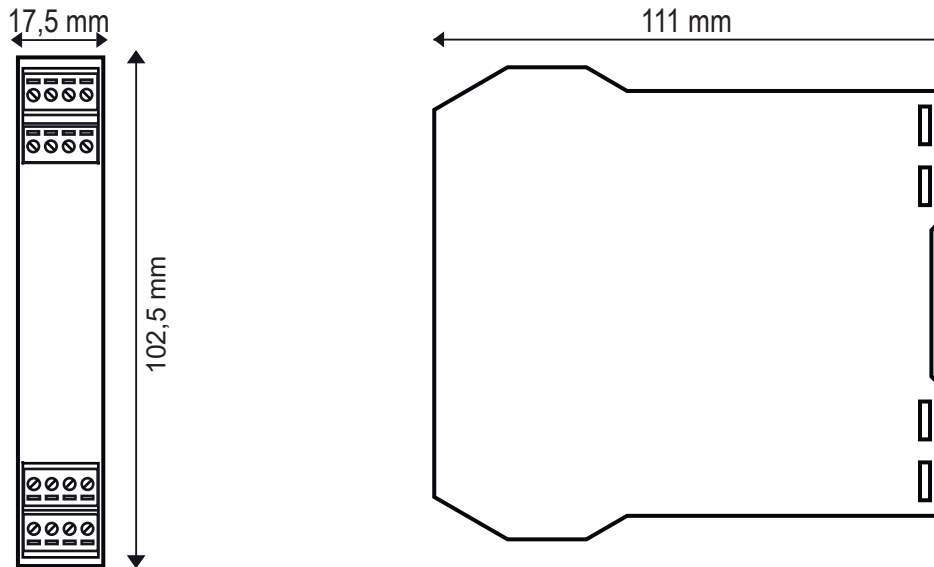





Dimensioni: 17,5 x 102,5 x 111 mm, **Peso:** 100 g; **Contenitore:** PA6, colore nero

SIGNALS VIA LED ON FRONT PANEL

LED	STATUS	LED meaning
PWR	ON	LED operation varies depending on the protocol used. Please refer to the user manual for correct operation.
COM	Flashing	
TX1	Flashing	Data transmission on port #1 RS485
RX1	Flashing	Data receipt on port #1 RS485
TX2	Flashing	Data transmission on port #2 RS485/RS232
RX2	Flashing	Data reception on port #2 RS485/RS232
ETH ACT Green	Flashing	Packet transmission on Ethernet port
ETH LNK Yellow	ON	Ethernet connection present

TECHNICAL SPECIFICATIONS

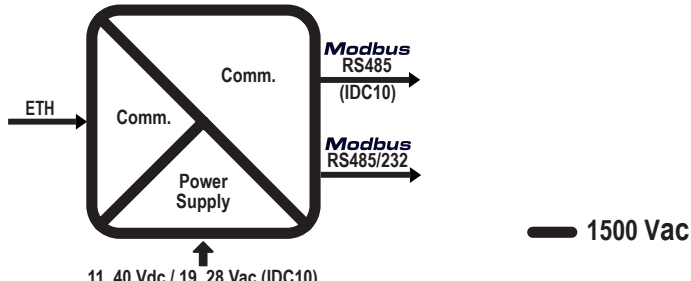
CERTIFICATIONS	   
INSULATION	

ENVIRONMENTAL CONDITIONS	Temperature: -25 °C – + 65 °C; Humidity: 30%– 90% non condensing. Altitude: Up to 2000 m above sea level; Storage temperature: -30 °C – + 85 °C Protection rating: IP20 (Not evaluated by UL)
ASSEMBLY	IEC EN60715, 35mm DIN rail in vertical position.
POWER SUPPLY	Voltage: 11 – 40 Vdc; 19 – 28 Vac 50 – 60 Hz; Absorption: Max. 1,5W
CONNECTIONS	3-way removable screw terminals, pitch 5 mm Rear connector IDC10 for DIN bar 46277 RJ45 front connector
COMMUNICATION PORTS	RS232 or RS485 switchable on terminal 10 - 11 - 12 (serial port 2) Maximum Baud rate 115 k, maximum cable length RS232 < 3m
	RS485 IDC10 rear connector: Maximum Baud rate 115 k. (serial port 1)
	RJ45 front Ethernet connector: 100 Mbit/s, maximum distance 100 m
CONFIGURATION	Configuration and FW update via webserver; Via DIP - SWITCH Via EASY SETUP 2 configuration software

⚠ ATTENTION

The device may only be powered by a power supply unit with a limited energy electric circuit max. 40Vdc / 28Vac output in accordance with CAN/CSA-C22.2 No. 61010-1-12 / UL Std. No. 61010-1 (3rd Edition) chapter 6.3.1/6.3.2 and 9.4 or class 2 according to CSA 223/UL 1310.

FACTORY IP ADDRESS

The default module IP address is static: **192.168.90.101**

NOTE: The Profinet protocol version does not have a static IP address.

SETTING THE DIP-SWITCHES

⚠ WARNING

The DIP-switch settings are read only at boot time. At each change, perform a restart.

SW2 DIP-SWITCH:

Through DIP-SWITCH-SW1 it is possible to set the IP configuration of the device:

DESCRIPTION	DIP 1	DIP 2	DIP 3	DIP 4
To obtain the configuration from the Flash memory, both SW1 DIP switch selectors must be set to OFF	<input type="checkbox"/>	<input type="checkbox"/>	RESERVED	RESERVED
To reset the device to factory settings both SW1 DIP switches must be set to ON	<input type="checkbox"/>	<input type="checkbox"/>	RESERVED	RESERVED
To force the device's IP address to the standard value of SENECA Ethernet products: 192.168.90.101	<input type="checkbox"/>	<input type="checkbox"/>	RESERVED	RESERVED
Reserved	<input type="checkbox"/>	<input type="checkbox"/>	RESERVED	RESERVED

KEY		
1	ON	<input type="checkbox"/>
0	OFF	<input type="checkbox"/>

⚠ ATTENTION

**DIP3 and DIP4, on models where they are present, must remain OFF.
If set otherwise, the instrument will not operate correctly.**

RS232/RS485 SETTING:

RS232 or RS485 configuration on terminals 10-11-12 (serial port 2)

SW2			
1	ON	<input type="checkbox"/>	RS232 ACTIVATION
0	OFF	<input type="checkbox"/>	RS485 ACTIVATION

PROFINET AND WEBSERVER MODE

In devices with Profinet, OPC-UA and IEC61850 protocols, to access the internal webserver it is necessary to switch the device to Webserver mode using the Easy Setup2 or Seneca Device Discovery software, it is also possible to change the operating mode by pressing the PS1 side button following the procedure in the user manual.

WEB SERVER

To access the maintenance Web Server with **192.168.90.101** factory IP address:

Default user: **admin**, Default password: **admin**, **http://192.168.90.101**

N.B.: For the Z-KEY-P version it is first necessary to activate webserver mode

⚠ CAUTION

DO NOT USE DEVICES WITH THE SAME IP ADDRESS IN THE SAME ETHERNET NETWORK.

INSTALLATION REGULATIONS

The module has been designed for vertical installation on a DIN 46277 rail. For optimal operation and long life, adequate ventilation must be provided. Avoid positioning ducting or other objects that obstruct the ventilation slots. Avoid mounting modules over heat-generating equipment. Installation in the bottom part of the electrical panel is recommended.

⚠ ATTENTION

These are open-type devices and intended for installation in an end enclosure / panel offering mechanical protection and protection against spread of fire.

ELECTRICAL CONNECTIONS

⚠ CAUTION

To meet the electromagnetic immunity requirements:

- use shielded signal cables;
- connect the shield to a preferential instrumentation earth system;
- separate shielded cables from other cables used for power installations (transformers, inverters, motors, etc...).

POWER SUPPLY

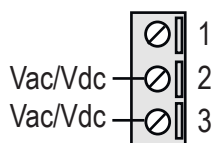

SERIAL PORT 2: RS485 SW2 = OFF

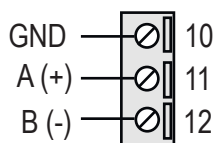

SERIAL PORT 2: RS232 SW2 = ON

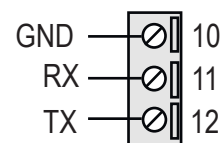

⚠ ATTENTION

Use only copper or copper-clad aluminium or AL-CU or CU-AL conductors

IDC10 CONNECTOR

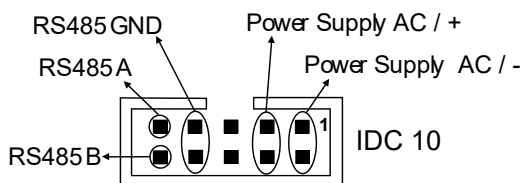

The illustration shows the meanings of the various IDC10 connector pins if signals are to be sent via them directly.