

   
100% Made & Designed in Italy

# INDUSTRIAL GATEWAYS

**PROTOCOL CONVERTERS**  
R-KEY / Z-KEY MODELS

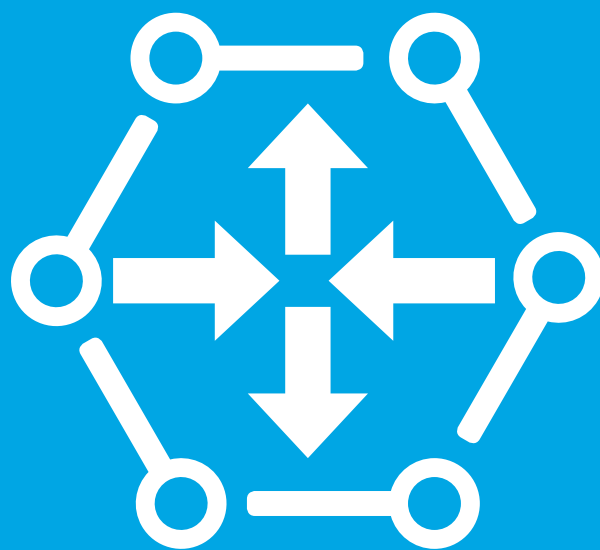

 **SENECA**

[www.seneca.it](http://www.seneca.it)



SENECA's DIN rail protocol converters - industrial gateways are devices used to transfer data between different networks and fieldbuses.

The gateways available in R (32x53x90mm) or Z (17.5x100x112mm) formats can be used within the infrastructure to facilitate communication between networks and systems with different protocols. Configuration is performed via a Web Server or the dedicated EASY SETUP 2 software. Available in various Master / Slave configurations and compatible with major PLCs, they are integrable into configurators from various manufacturers.

**HIGHLIGHTS**



**PROTOCOL CONVERSION**  
Industrial gateways connect Modbus devices to networks and fieldbuses by bidirectionally converting protocols such as ModBUS RTU/TCP-IP, M-BUS, Profinet, IO, M-BUS, Ethernet/IP0, OPC UA, IEC 61850.

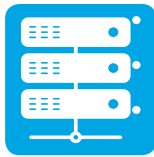

**SERIAL DEVICE SERVER**  
Gateways in this mode connect devices with RS232 or RS485 serial interfaces to a local network for the transmission of serial data via Ethernet.



**CONNECTIVITY**  
Gateways manage up to 128 slave nodes per serial port, 1,200 bytes read/write, and 10 TCP-IP Servers.



**FLEXIBLE CONFIGURATION**  
Configuration through serial, Ethernet, or USB ports is straightforward and immediate using the EASY SETUP 2 configuration software or a web server.

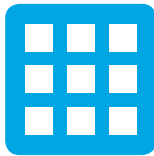

**SHARED MEMORY**  
In the "Tag - 'shared memory'" Gateway mode, SENECA devices continuously acquire data via ModBUS and store it in their shared memory.



**SERIAL SNIFFERS**  
With the serial sniffer feature, gateways analyze serial network traffic and display ModBUS protocol variables.



**CERTIFICATIONS**  
Having passed stringent tests for potential fire hazards, electrical shocks, and mechanical failures, many models are equipped with UL certification.



**INTEGRATION**  
"KEY" gateways facilitate compatibility and coexistence with PLCs, automation systems, and third-party programming environments (e.g., TIA Portal, PLCLogix 5000) thanks to the generation of specific configuration files EDS or GDSML.

**AVAILABLE CONVERSIONS AND MODELS**

PLC Side / Field Side	Modbus RTU	Modbus ASCII	Modbus TCP/IP	PROFINET	ETHERNET/IP
Modbus RTU		R-KEY-LT Z-KEY-0 Z-KEY-2ETH	R-KEY-LT Z-KEY-0 Z-KEY-2ETH	R-KEY-LT-P Z-KEY-P Z-KEY-2ETH-P	R-KEY-LT-E Z-KEY-E Z-KEY-2ETH-E
Modbus ASCII	R-LT Z-KEY-0 Z-KEY-2ETH		R-KEY-LT Z-KEY-0 Z-KEY-2ETH	R-KEY-LT-P Z-KEY-P Z-KEY-2ETH-P	R-KEY-LT-E Z-KEY-E Z-KEY-2ETH-E
Modbus TCP/IP	R-KEY-LT Z-KEY-0 Z-KEY-2ETH	R-KEY-LT Z-KEY-0 Z-KEY-2ETH		R-KEY-LT-P Z-KEY-P Z-KEY-2ETH-P	R-KEY-LT-E Z-KEY-E Z-KEY-2ETH-E
M-Bus	R-KEY-MBUS Z-KEY-MBUS		R-KEY-MBUS Z-KEY-MBUS	R-KEY-MBUS-P (*) Z-KEY-MBUS-P (*)	

(\*) Soon available

## FLEXIBLE AND RECONFIGURABLE DEVICES WITH FLEX TECHNOLOGY



SENECA's proprietary FLEX technology allows connecting a single device capable of supporting various protocols in serial and Ethernet industrial communication networks. From the same gateway, for example, it is possible to change the type of protocol conversion in a few steps, quickly addressing changes in production layouts or efficiently transferring data to and from PLCs and other Master/Slave or Client/Server devices. This flexible approach saves time, financial resources, and the hassle of managing multiple devices with different purchasing codes, regardless of the application type.

### STRENGTHS

- A single multiprotocol solution on one device
- Maximum connectivity in a single hardware
- The functionality of multiple gateways at the price of one
- Simplification of purchasing codes
- Reduction in storage and handling costs
- Immediate selection of multiple protocol combinations based on the freely downloadable Seneca Discovery Device tool from the Seneca website
- No programming software or change of tag and I/O registers needed
- Supported and interchangeable protocols: ModBUS RTU, ModBUS TCP-IP, ModBUS ASCII, Profinet, Ethernet/IP, upcoming implementations (OPC UA, IEC 61850)
- Models integrating FLEX technology: R-KEY-LT, R-KEY-LT-E, R-KEY-LT-P, Z-KEY-0, Z-KEY-2ETH, Z-KEY-2ETH-E, Z-KEY-2ETH-P, Z-KEY-P, Z-KEY-E, upcoming integrations (R203-2-L; R203-2-H, R203-2-L-P, R203-H-P)

### PROTOCOL RECONFIGURATION PROCEDURE WITH FLEX TECHNOLOGY

- Connect the PC to the FLEX device via Ethernet
- Launch the SENECA DISCOVERY DEVICE software, available on the SENECA website; scan the ModBUS / Ethernet network
- Select the new combination of protocols to apply to the device
- With the module turned off, set the DIP Switch to "Factory Reset"
- Turn on the module and set the DIP Switch to "Read configuration from Flash"

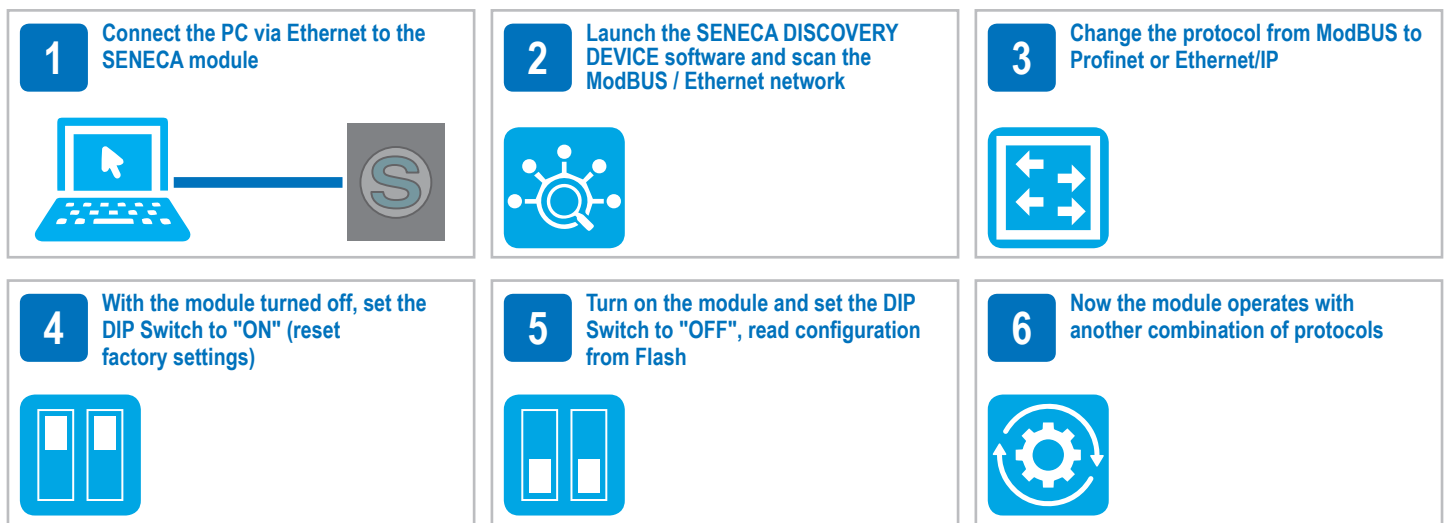

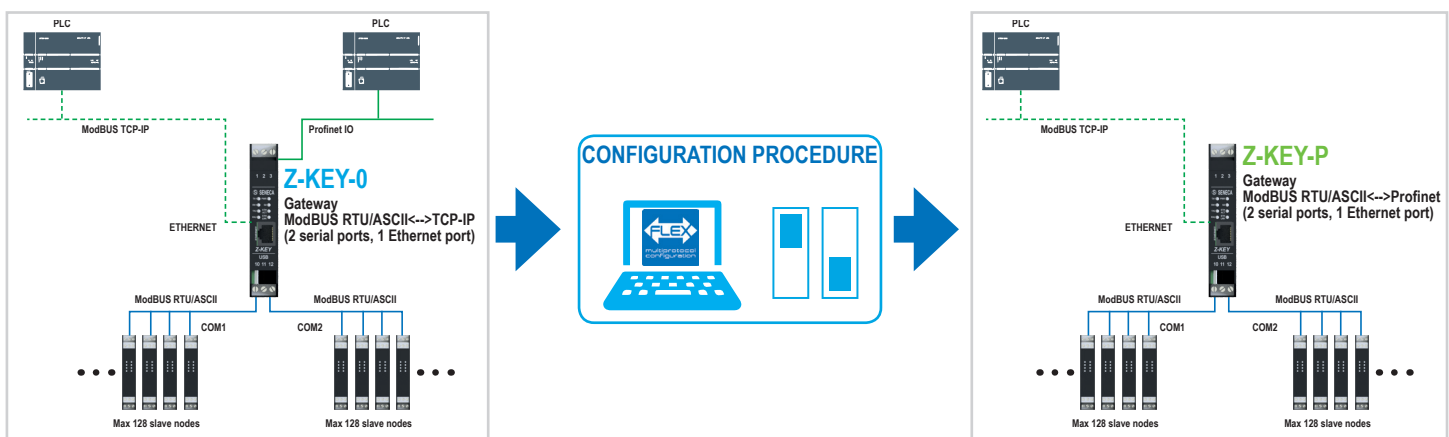

For more information: [www.seneca.it/flex](http://www.seneca.it/flex)

### EXAMPLE OF TRANSFORMATION FROM MODBUS GATEWAY TO PROFINET GATEWAY



## TECHNICAL DATA











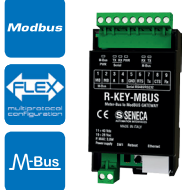

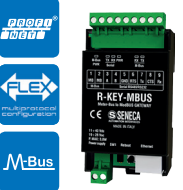



## ModBUS Gateways

	R-KEY-LT	Z-KEY-0	Z-KEY-2ETH
This family of gateways allows connecting PLCs with serial, ModBUS, or Ethernet interfaces to ModBUS RTU/ASCII Master/Slave and TCP-IP Client/Server devices			
	ModBUS RTU/ASCII Gateway ↔ TCP-IP (1 serial port, 1 Ethernet port)	ModBUS RTU/ASCII Gateway ↔ TCP-IP (2 serial ports, 1 Ethernet port)	ModBUS RTU/ASCII Gateway ↔ TCP-IP (2 serial ports, 2 Ethernet ports)
<b>GENERAL DATA</b>			
Power Supply	10..40 Vdc; 19..28 Vac	11..40 Vdc; 19..28 Vac	10..40 Vdc; 19..28 Vac
Max Consumption	1 W	1.5 W	2 W
Max isolation		1.5 kVac (Ethernet)	
LED, status indicators		Power Supply Rx/Tx RS232/R485 Ethernet ACT/LNK	
Protection degree		IP20	
Operating temperature		-25 °C.. +65 °C	
Connections	7-way removable screw terminal, 5 mm pitch 2-way removable screw terminal, 5 mm pitch Bottom RJ45 connector	Removable screw terminals 3 ways, pitch 5 mm Rear IDC10 connector for DIN rail 46277 Front RJ45 connector	Front RJ45 connector (x2)
Dimensions (WxHxD)	32 x 53 x 90 mm	17.5 x 100 x 112 mm	
Weight	80 g	100 g	170 g
Enclosure	PC/ABS self-extinguishing UL94-V0, Grey RAL 7035	Nylon PA6 30% glass fiber, self-extinguishing class V0	
Installation		For DIN rail (IEC EN 60715)	
Certifications		CE, UKCA, UL	
<b>COMMUNICATION</b>			
Ethernet Ports		#1 Fast Ethernet 100 Tx	port #2 Fast Ethernet 100 Tx ports, switch configuration
Serial Ports #1		#1 serial port RS232 / RS485 switchable, max baud rate 115kbps on connector	
#2	-	#1 RS485 port, max baud rate 115k on IDC10 connector for bus and terminals	
Supported Protocols		ModBUS TCP-IP ModBUS RTU ModBUS ASCII	
Operating Modes		ModBUS RTU/ASCII TCP-IP Gateway ModBUS 'TAG' Gateway Serial Device Server TCP Server Serial Device Modbus Gateway Serial to Ethernet Virtual ID	
FLEX (multiprotocol configuration)		Yes	
Variable memory area		500 tags	
Connectivity		Max 8 TCP-IP Clients (Server Mode) Max 10 TCP-IP Servers (Client Mode) Max 128 Slave Nodes ModBUS RTU/ASCII per serial port	
<b>CONFIGURATION</b>			
DIP Switch		Yes	
WEB SERVER		Yes	
EASY SETUP 2		Yes	
EDS/GSDML		-	
SDD (Seneca Discovery Device)		Yes	
SESC (Seneca Ethernet to Serial Connection)		Yes	
<b>ORDER CODES</b>	R-KEY-LT	Z-KEY-0	Z-KEY-2ETH

The technical data and diagrams in this document are indicative and not binding.

## TECHNICAL DATA

### M-BUS Gateways

	R-KEY-MBUS	Z-KEY-MBUS	R-KEY-MBUS-P	Z-KEY-MBUS-P
<p>This family of gateways enables conversion from M-BUS (Meter Bus) protocol to ModBUS RTU / ModBUS TCP-IP and Profinet. These converters are capable of reading, converting, and transferring data from up to 25 M-BUS devices.</p>    	  	  	  	  
	ModBUS RTU/TCP-IP ↔ M-BUS (1 M-BUS port, 1 serial port, 1 Ethernet port)	ModBUS RTU/TCP-IP ↔ M-BUS (1 M-BUS port, 2 serial ports, 1 Ethernet port)	Profinet Gateway ↔ M-BUS (1 M-BUS port, 1 serial port, 1 Ethernet port)	Profinet Gateway ↔ M-BUS (1 M-BUS port, 2 serial ports, 1 Ethernet port)
<b>GENERAL DATA</b>				
Power Supply	10..40 Vdc; 19..28 Vac			
Max Consumption	Max 1 W	6.5 W (3.5 W typical)	Max 1 W	6.5 W (3.5 W typical)
Max isolation	1,500 Vac	1,500 Vac across 3 ways	1,500 Vac	1,500 Vac across 3 ways
LED status indicators	Power Supply M-BUS Power Supply Rx/Tx RS232/R485 M-BUSTx/Rx			
Protection degree	IP20			
Operating temperature	-25..+65°C			
Connections	Screw terminals, 7-way removable screw terminal, 5 mm pitch Screw terminals, 2-way removable screw terminal, 5 mm pitch Ethernet connector on the bottom side	Removable screw terminals 3 ways, pitch 5 mm Rear IDC10 connector for DIN rail 46277 Front RJ45 connector Side Micro USB	Screw terminals, 7-way removable screw terminal, 5 mm pitch Screw terminals, 2-way removable screw terminal, 5 mm pitch Ethernet connector on the bottom side	Removable screw terminals 3 ways, pitch 5 mm Rear IDC10 connector for DIN rail 46277 Front RJ45 connector Side Micro USB
Dimensions (WxHxD)	53.3 x 90 x 32.2 mm	100 x 35 x 112 mm	53.3 x 90 x 32.2 mm	100 x 35 x 112 mm
Weight	80 g	190 g	80 g	190 g
Enclosure	PC / ABS self-extinguishing UL94-V0	Black glass-filled PA6 plastic, black color	PC / ABS self-extinguishing UL94-V0	Black glass-filled PA6 plastic, black color
Installation	On DIN rail IEC EN 60715 or wall-mounted		On DIN rail IEC EN 60715 or wall-mounted	
Certifications	CE, UKCA			
<b>COMMUNICATION</b>				
Ethernet Ports	#1 Fast Ethernet 100 Tx port, RJ45		#1 Fast Ethernet 100 Tx port, RJ45	
Serial Ports	#1 switchable RS232 / RS485 serial port, max baud rate 115kpbs			
#1				
#2	#1 RS485 port, max baud rate 115k on IDC10 connector for bus and terminals		#1 RS485 port, max baud rate 115k on IDC10 connector for bus and terminals	
USB Ports	#1 Micro USB port on side connector		#1 Micro USB port on side connector	
M-BUS Ports	#1 M-BUS port, max 25 slave nodes, baud rate from 300 to 38,400 bps			
Supported Protocols	ModBUS TCP-IP server ModBUS RTU slave M-BUS Master		Profinet IO (Class A Device, Cyclic Real-Time (RT), Acyclic Data) M-BUS Master	
Operating Modes	ModBUS RTU/TCP-IP ↔ M-BUS		Profinet IO Gateway ↔ M-BUS	
FLEX (multiprotocol configuration)	Yes			
Variable memory area	500 tags			
Connectivity	Max 8 TCP-IP Clients (Server Mode) Max 128 slave nodes ModBUS RTU/ASCII Max 25 slave nodes M-BUS			
<b>CONFIGURATION</b>				
DIP Switch	Yes			
WEB SERVER	Yes			
EASY SETUP 2	-		Yes	
EDS/GSDML	-		Yes	
SDD (Seneca Discovery Device)	Yes			
<b>ORDER CODES</b>	R-KEY-MBUS	Z-KEY-MBUS	R-KEY-MBUS-P	Z-KEY-MBUS-P

The technical data and diagrams in this document are indicative and not binding.

## TECHNICAL DATA

## PROFINET IO Gateways

## R-KEY-LT-P

## Z-KEY-P

## Z-KEY-2ETH-P

This family of gateways allows connecting PLCs with Profinet IO interfaces to ModBUS RTU/ ASCII Master/Slave devices and ModBUS TCP-IP Server.



ModBUS ↔ Profinet IO Gateways  
(1 serial port, 1 Ethernet port)

ModBUS ↔ Profinet IO Gateways  
(2 serial ports, 1 Ethernet port)

ModBUS ↔ Profinet IO Gateways  
(2 serial ports, 2 Ethernet ports)

## GENERAL DATA

Power Supply	10..40 Vdc; 19..28 Vac	11..40 Vdc; 19..28 Vac	
Max Consumption	1 W	1.5 W	2 W
Max isolation		1,500 Vac	
LED, status indicators		Power Supply Rx/Tx RS232/R485 Ethernet ACT/LNK Profinet Communication	
Protection degree		IP20	
Operating temperature		-25 °C..+65 °C	
Connections	Screw terminals, 7-way removable screw terminal, 5 mm pitch	Removable screw terminals 3 ways, pitch 5 mm	
	Screw terminals, 2-way removable screw terminal, 5 mm pitch	Rear IDC10 connector for DIN rail 46277	
	RJ45 connector on the bottom (x1)	Front RJ45 connector (x1)	Front RJ45 connector (x2)
Dimensions (WxHxD)	32 x 53 x 90 mm	17.5 x 100 x 112 mm	
Weight	80 g	100 g	170 g
Enclosure	PC/ABS self-extinguishing UL94-V0, Grey RAL 7035	Nylon PA6 30% glass fiber, V0 flame retardant class	
Installation		For DIN rail (IEC EN 60715)	
Certifications		CE, UKCA, UL	

## COMMUNICATION

Ethernet Ports	#1 Fast Ethernet 100 Tx port, RJ45	#2 Fast Ethernet 100 Tx ports, front RJ45 (switch configuration)	
Serial Ports	#1	#1 serial port RS232 / RS485 switchable, max baud rate 115kbps on connector	
	#2	-	#1 RS485 port, max baud rate 115k on IDC10 connector for bus and terminals
Supported Protocols	ModBUS TCP-IP ModBUS RTU MQTT ModBUS ASCII Profinet IO (Class A Device, Cyclic Real-time (RT) and Acyclic Data)		
Operating Modes	Profinet IO ModBUS RTU/TCP-IP Master Gateway Profinet IO ModBUS RTU/TCP-IP Slave Gateway Gateway with tag for Port#1 and Port#2 Master		
FLEX (multiprotocol configuration)	Yes		
Variable memory area	1200 Byte R + 1200 Byte W		
Connectivity	Max 3 TCP-IP Servers (Client Mode) Max 8 TCP-IP Clients Max 128 Slave Nodes ModBUS RTU/ASCII for serial port		

## CONFIGURATION

DIP Switch	Yes
WEB SERVER	Yes
EASY SETUP 2	Yes
EDS/GSDML	Yes
SDD (Seneca Discovery Device)	Yes
SESC (Seneca Ethernet to Serial Connection)	-
ORDER CODES	R-KEY-LT-P                      Z-KEY-P                      Z-KEY-2ETH-P

The technical data and diagrams in this document are indicative and not binding.

## TECHNICAL DATA

### Ethernet / IP Gateways

Allows PLCs with Ethernet/IP interface to connect to ModBUS RTU Master/Slave and ModBUS TCP-IP Server devices.

#### R-KEY-LT-E

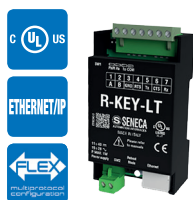

ModBUS → Ethernet/IP (1 serial port, 1 Ethernet port)

#### Z-KEY-E



ModBUS → Ethernet/IP (2 serial ports, 1 Ethernet port)

#### Z-KEY-2ETH-E



ModBUS → Ethernet/IP (2 serial ports, 2 Ethernet ports)

### GENERAL DATA

<b>Power Supply</b>		10..40 Vdc; 19..28 Vac	
<b>Max Consumption</b>	1 W	1.5 W	2 W
<b>LED Status Indicators</b>		Power Supply Ethernet port connections RX / TX RS232/RS485 RX/TX RS485 Ethernet/IP Communication	
<b>Max isolation</b>		1.5 kVac	
<b>Protection degree</b>		IP20	
<b>Operating temperature</b>		-25..+65°C	
<b>Connections</b>	Screw terminals, 7-way removable screw terminal, 5 mm pitch Screw terminals, 2-way removable screw terminal, 5 mm pitch RJ45 connector on the bottom	Removable screw terminals 3 ways, pitch 5 mm Rear IDC10 connector for DIN rail 46277 Front RJ45 connector	Front RJ45 connector (x2)
<b>Dimensions (WxHxD)</b>	32 x 53 x 90 mm	17.5 x 100 x 112 mm	
<b>Weight</b>	80 g	100 g	170 g
<b>Enclosure</b>	PC/ABS self-extinguishing UL94-V0	Nylon 6 with 30% glass fiber, V0 flame retardant class	
<b>Installation</b>		For DIN rail (IEC EN 60715)	
<b>Certifications</b>		CE, UKCA, UL	

### COMMUNICATION

<b>Ethernet Ports</b>	#1 Fast Ethernet 100 Tx port, RJ45	#2 Fast Ethernet 100 Tx ports, front RJ45
<b>Serial Ports #1</b>	#1 serial port RS232 / RS485 switchable, max baud rate 115kbps on connector	
<b>#2</b>	-	#1 RS485 port, max baud rate 115k on IDC10 connector for buses and terminals
<b>Supported Protocols</b>	ModBUS RTU, ModBUS TCP-IP, ModBUS ASCII MQTT	
<b>Operating Modes</b>	ModBUS RTU/TCP-IP/ASCII ↔ Ethernet/IP Gateway	
<b>FLEX (multiprotocol configuration)</b>	Yes	
<b>Variable memory area</b>	512 Byte R + 512 Byte W	
<b>Connectivity</b>	Max 3 TCP-IP clients (Server Mode) Max 128 slave nodes ModBUS RTU/ASCII	

### CONFIGURATION

<b>DIP Switch</b>	Yes
<b>WEB SERVER</b>	Yes
<b>EASY SETUP 2</b>	Yes
<b>EDS/GSDML</b>	Yes
<b>SDD (Seneca Discovery Device)</b>	Yes
<b>SESC (Seneca Ethernet to Serial Connection)</b>	-
<b>ORDER CODES</b>	R-KEY-LT-E                      Z-KEY-E                      Z-KEY-2ETH-E

The technical data and diagrams in this document are indicative and not binding.

## TECHNICAL DATA

## OPC UA Gateways

## R-KEY-LT-P

## Z-KEY-P

## Z-KEY-2ETH-P

This family of gateways allows OPC Servers to connect to ModBUS RTU/TCP-IP Master devices and systems.

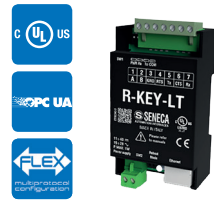

ModBUS ↔ OPC UA Gateway (1 serial port, 1 Ethernet port)

ModBUS ↔ OPC UA Gateway (2 serial ports, 1 Ethernet port)

ModBUS ↔ OPC UA Gateway (2 serial ports, 2 Ethernet ports)

## GENERAL DATA

Power Supply		10..40 Vdc; 19..28 Vac
Max Consumption	1 W	2 W @ 24 Vac (typical)
Max isolation		1,500 Vac
LED, status indicators		Power Supply Rx/Tx RS232/R485 Ethernet ACT/LNK
Protection degree		IP20
Operating temperature		-25 °C..+65 °C
Connections	Screw terminals, 7-way removable screw terminal, 5 mm pitch Screw terminals, 2-way removable screw terminal, 5 mm pitch RJ45 connector on the bottom (x1)	Removable screw terminals 3 ways, pitch 5 mm Rear IDC10 connector for DIN rail 46277 Front RJ45 connector (x1)      Front RJ45 connector (x2)
Dimensions (WxHxD)	32 x 53 x 90 mm	17.5 x 100 x 112 mm
Weight	80 g	170 g
Enclosure	PC/ABS self-extinguishing UL94-V0, Grey RAL 7035	Nylon PA6 30% glass fiber, V0 flame retardant class
Installation		For DIN rail (IEC EN 60715)
Certifications		CE, UKCA, UL

## COMMUNICATION

Ethernet Ports	#1 Fast Ethernet 100 Tx port, RJ45	#2 Fast Ethernet 100 Tx ports, front RJ45 (switch configuration)
Serial Ports	-	#1 serial port RS232 / RS485 switchable, max baud rate 115kbps on connector
Supported Protocols		ModBUS TCP-IP ModBUS RTU ModBUS ASCII OPC UA
Operating Modes		OPC UA Server Gateway ↔ ModBUS RTU/TCP-IP Master
FLEX (multiprotocol configuration)		Yes
Variable memory area		1200 Bytes R/W
Connectivity		Max 3 TCP-IP Servers (Client Mode) 128 ModBUS RTU/ASCII slave nodes per serial port

## CONFIGURATION

DIP Switch	Yes
WEB SERVER	Yes
EASY SETUP 2	Yes
EDS/GSDML	Yes
SDD (Seneca Discovery Device)	Yes
SESC (Seneca Ethernet to Serial Connection)	-
ORDER CODES	R-KEY-LT-U                      Z-KEY-U                      Z-KEY-2ETH-U

The technical data and diagrams in this document are indicative and not binding.



## TECHNICAL DATA

### IEC 61850 Gateways

#### R-KEY-LT-I

#### Z-KEY-I

#### Z-KEY-2ETH-I

This family of gateways allows IEC 61850 Servers to connect to ModBUS RTU/TCP-IP devices and systems. Master



ModBUS ↔ IEC 61850 Gateway (1 serial port, 1 Ethernet port)

ModBUS ↔ IEC 61850 Gateway (2 serial ports, 1 Ethernet port)

ModBUS ↔ IEC 61850 Gateway (2 serial ports, 2 Ethernet ports)

### GENERAL DATA

Power Supply	10..40 Vdc; 19..28 Vac	
Max Consumption	1 W	2 W @ 24 Vac (typical)
Max isolation	1,500 Vac	
LED, status indicators	Power Supply Rx/Tx RS232/R485 Ethernet ACT/LNK	
Protection degree	IP20	
Operating temperature	-25 °C..+65 °C	
Connections	Screw terminals, 7-way removable screw terminal, 5 mm pitch	Removable screw terminals 3 ways, pitch 5 mm
	Screw terminals, 2-way removable screw terminal, 5 mm pitch	Rear IDC10 connector for DIN rail 46277
	RJ45 connector on the bottom (x1)	Front RJ45 connector (x1)      Front RJ45 connector (x2)
Dimensions (WxHxD)	32 x 53 x 90 mm	17.5 x 100 x 112 mm
Weight	80 g	170 g
Enclosure	PC/ABS self-extinguishing UL94-V0, Grey RAL 7035	Nylon PA6 30% glass fiber, V0 flame retardant class
Installation	For DIN rail (IEC EN 60715)	
Certifications	CE, UKCA, UL	

### COMMUNICATION

Ethernet Ports	#1 Fast Ethernet 100 Tx port, RJ45	#2 Fast Ethernet 100 Tx ports, front RJ45 (switch configuration)
Serial Ports	#1 serial port RS232 / RS485 switchable, max baud rate 115kbps on connector	
Supported Protocols	ModBUS TCP-IP ModBUS RTU ModBUS ASCII IEC 61850 Server	
Operating Modes	IEC 61850 Server Gateway ↔ ModBUS RTU/TCP-IP Master	
FLEX (multiprotocol configuration)	Yes	
Variable memory area	512 Bytes R / 512 Bytes W	
Connectivity	Max 3 TCP-IP Servers 128 ModBUS RTU/ASCII slave nodes per serial port	

### CONFIGURATION

DIP Switch	Yes
WEB SERVER	Yes
EASY SETUP 2	Yes
EDS/GSDML	Yes
SDD (Seneca Discovery Device)	Yes
SESC (Seneca Ethernet to Serial Connection)	-
<b>ORDER CODES</b>	R-KEY-LT-I      Z-KEY-I      Z-KEY-2ETH-I

The technical data and diagrams in this document are indicative and not binding.

APPLICATION DIAGRAMS

MODBUS GATEWAY - ETHERNET TO SERIAL

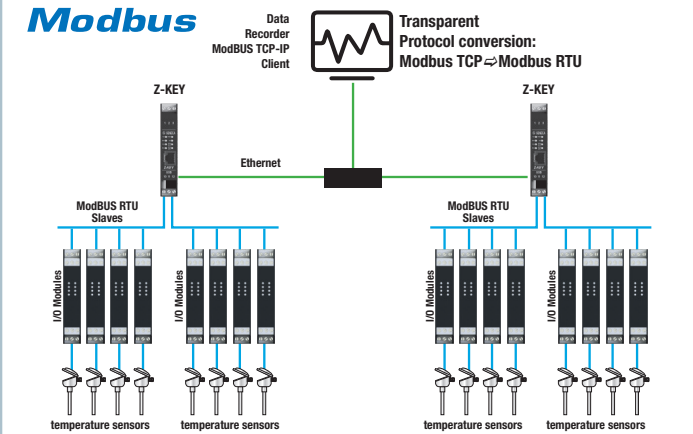

EXTENDED SERIAL OVER ETHERNET

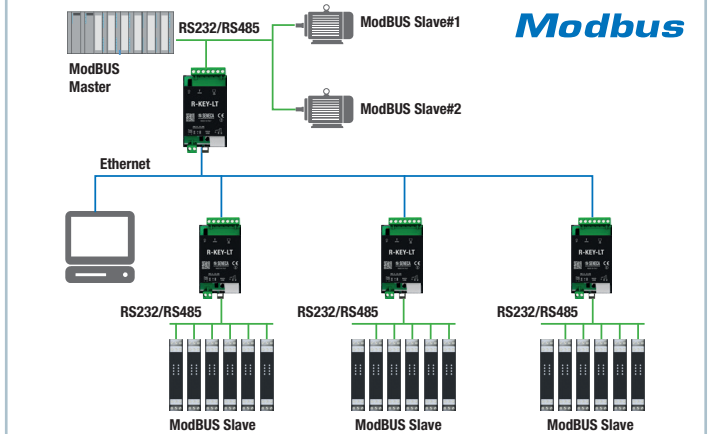

SERIAL DEVICE SERVER - VIRTUAL COM

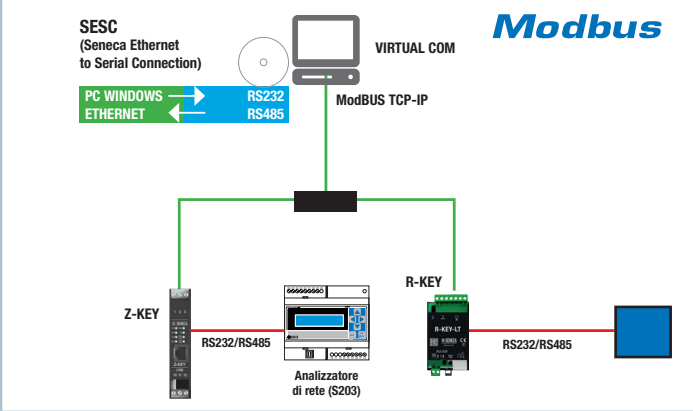

ETHERNET/IP GATEWAY - ADAPTER

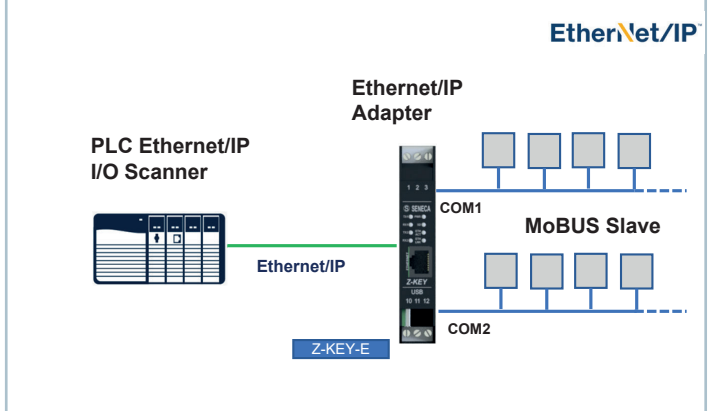

M-BUS GATEWAY - PLC CONNECTION

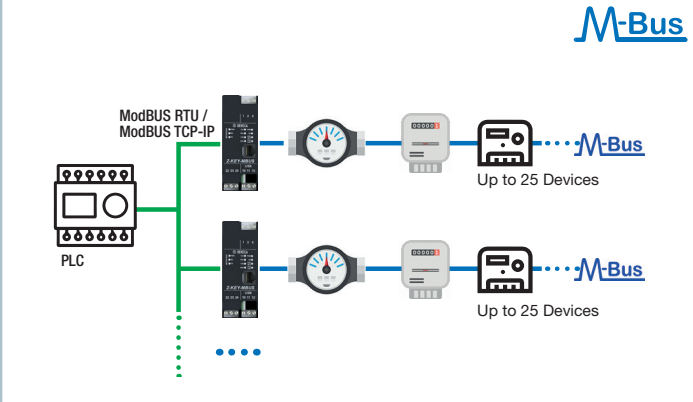

M-BUS GATEWAY - SCADA CONNECTION

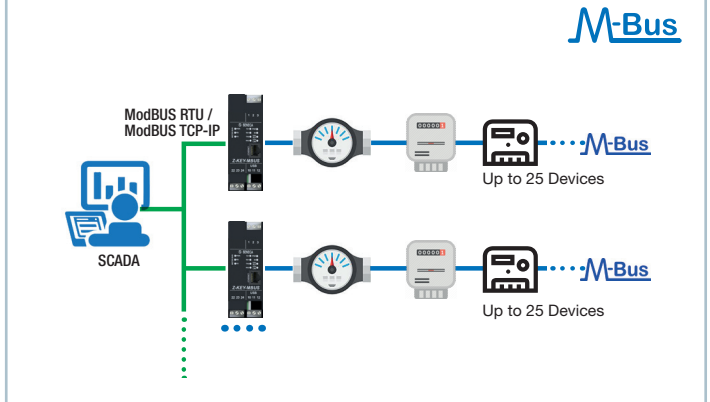

PROFINET IO TO MODBUS GATEWAY MASTER

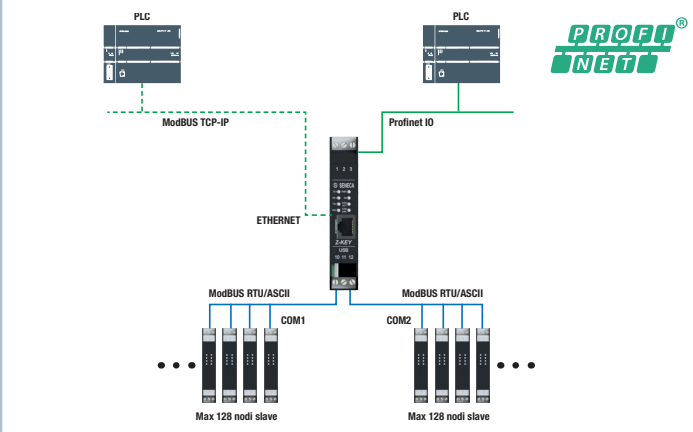

PROFINET IO TO MODBUS GATEWAY SLAVER

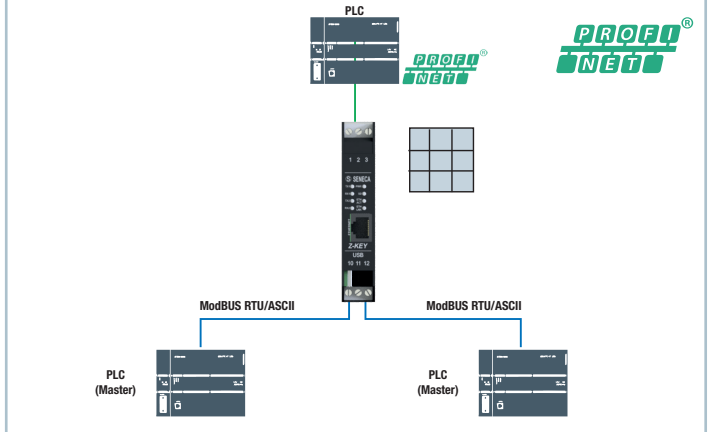





## CONTACTS AND INFORMATION

### Address

Legal and Operational Headquarters:  
Via Austria 26: Via Austria 26 - 35127 Padova (I)  
Tel. +39 049 8705 359 (408)  
Fax +39 049 8706287

### Web

Website: [www.seneca.it](http://www.seneca.it)  
Documentation: [www.seneca.it/cataloghi-flyers/](http://www.seneca.it/cataloghi-flyers/)  
Support: [www.seneca.it/supporto-e-assistenza/](http://www.seneca.it/supporto-e-assistenza/)  
E-commerce: [www.seneca.it/vetrina/](http://www.seneca.it/vetrina/)

### Email

General information: [info@seneca.it](mailto:info@seneca.it)  
Sales office: [commerciale@seneca.it](mailto:commerciale@seneca.it)  
Quality Assurance: [qualita@seneca.it](mailto:qualita@seneca.it)  
Technical product support: [supporto@seneca.it](mailto:supporto@seneca.it)

### Follow us on social media



The information provided in this document may be changed or supplemented without prior notice due to technical and commercial needs. Despite continuous efforts for perfection, discrepancies and inaccuracies cannot be ruled out. The content of this document is subject to periodic review.