





# INSTALLATION MANUAL

## MyALARM3 Cloud W-AIR

### PRELIMINARY WARNINGS

The word **WARNING** preceded by the symbol  indicates conditions or actions that put the user's safety at risk. The word **ATTENTION** preceded by the symbol  indicates conditions or actions that might damage the instrument or the connected equipment.

The warranty shall become null and void in the event of improper use or tampering with the module or devices supplied by the manufacturer as necessary for its correct operation, and if the instructions contained in this manual are not followed.

	<b>WARNING:</b> The full content of this manual must be read before any operation. The module must only be used by qualified electricians. Specific documentation is available using the QR-CODE shown on page 1.
	The module must be repaired and damaged parts replaced by the Manufacturer. The product is sensitive to electrostatic discharges. Take appropriate measures during any operation.
	Electrical and electronic waste disposal (applicable in the European Union and other countries with recycling). The symbol on the product or its packaging shows the product must be surrendered to a collection centre authorized to recycle electrical and electronic waste.



DOCUMENTATION



APP



SENECA s.r.l.; Via Austria, 26 – 35127 – PADOVA – ITALY; Tel. +39.049.8705359 - Fax +39.049.8706287

### CONTACT INFORMATION

Technical support	support@seneca.it	Product information	sales@seneca.it
-------------------	-------------------	---------------------	-----------------

This document is the property of SENECA srl. Copies and reproduction are prohibited unless authorised.  
The content of this document corresponds to the described products and technologies.  
Stated data may be modified or supplemented for technical and/or sales purposes.

# MODULE LAYOUT

## CASE DIMENSIONS

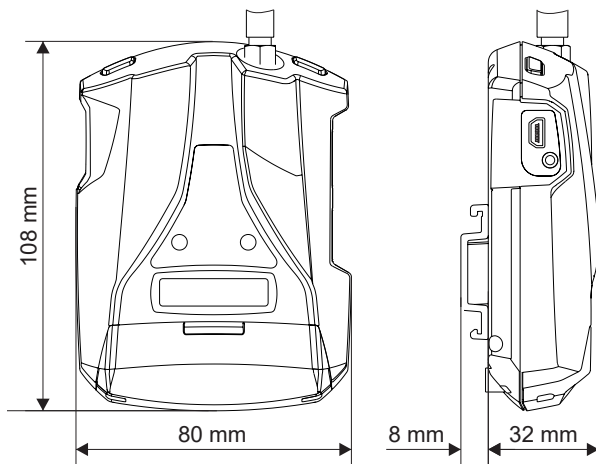

## SYMBOLS ON THE ENCLOSURE

	ON / OFF power button
	Display page change button
	Slot for micro SD card
	Micro USB connector

<b>Weight</b>	150 g	<b>Case</b>	Polycarbonate / ABS material
---------------	-------	-------------	------------------------------

## SIGNALS VIA LED ON FRONT PANEL

LED	STATUS	LED MEANING
<b>NET (YELLOW)</b>	Off	WiFi off
	Continuous fast flashing	Connection error to the WiFi network (*)
	Continuous slow flashing	Access Point mode set
	Flashing	Data sending
<b>PWR (GREEN)</b>	On	Connected to the WiFi router in Station mode
	Off	MyAlarm3 W-AIR Cloud OFF
	Flashing	Battery operation
	On	MyAlarm3 W-AIR Cloud on and powered

### (\*) Possible errors in the connection to the WiFi network:

- Entering an incorrect password
- Entering an incorrect SSID
- Excessive distance between the MyAlarm3 Cloud W-AIR control unit and the WiFi router
- Lack of WiFi signal due to shielding or network problems
- Failure or incorrect installation of the antenna on the control unit

## SAFETY REGULATIONS



### WARNING

- Do not apply different voltages or higher voltages than indicated between terminals, or between any terminal and earth (voltages greater than 50Vdc)
- Do not use the control unit if damaged, or if signs of possible damage are visible on it.
- Do not remove the internal battery.
- Do not use the control unit if it runs abnormally.
- Do not touch the control unit terminals during use
- For a correct use, use the cables supplied.

### CAUTION

- Make sure the internal battery is charged if you intend to use the MyAlarm3 Cloud control unit without power.
- Use the MyAlarm3 Cloud W= AIR control unit as described in the manual downloadable at [www.seneca.it/myalarm3-cloud-w-air](http://www.seneca.it/myalarm3-cloud-w-air).
- Before each use, refer to the electrical connections shown in the manual.

## TECHNICAL SPECIFICATIONS

<b>CERTIFICATES</b>	  
<b>Power supply</b> <i>Voltage</i> <i>Absorption</i> <i>Internal batteries</i>	6 - 15 Vdc; 500 mA Max. 3.5 W Max Lithium Ions 3.7 V, 1100 mAh, rechargeable non-replaceable
<b>Voltage output</b>	+12 Vdc 50 mA (maximum current)
<b>Temperature sensor</b>	NTC thermistor (*)
<b>Environmental conditions</b> <i>Temperature</i>  <i>Humidity</i>  <i>Storage temperature</i>  <i>Protection rating</i>	<u>Seneca recommends use at 0 to 45°C for correct operation</u>  With the power supply present: -20 ÷ 55°C. With use of the battery (when discharged): -20 ÷ 5°C Charging is possible in the range: 0 ÷ 45°C.  30%– 90% non condensing.  From -20°C to 20°C < 1 year; from -20°C to 45°C < 3 months; from -20°C to 60°C < 1 month  IP40
<b>Connections</b>	Spring clamps, 3.5 mm pitch, connector for Micro USB and SMA connector for WIFI Antenna
<b>Slot Type / Memory Micro SD</b>	Push-Push for micro SD card and SD HC card / max 32GB
<b>Digital inputs</b> <i>Type</i> <i>Maximum frequency</i> <i>Threshold OFF</i> <i>Threshold ON</i>	4 inputs Reed, contact, PNP, Pulscap 30 Hz 0 ÷ 3 Vdc, I > 1 mA 6 ÷ 24 Vdc, I > 3 mA
<b>Analog inputs</b>	2 inputs, Voltage 0 ÷ 30 Vdc / Current 0 ÷ 20 mA, 0.1% of full scale
<b>Display</b>	128x32 LCD Dots with visible area of 39 mm x 8.6 mm
<b>USB</b>	1 micro USB for configuration
<b>WiFi</b>	2.4GHz (802.11B/G/M; 802.11n Up to 150Mbps)
<b>Digital outputs</b>	2 outlets Relay 3 A max - 250 V SPST (with shared terminal)

\* To view all the product's accessory tools, visit the dedicated page on the [www.seneca.it](http://www.seneca.it) website

## CONTROL UNIT INSTALLATION AND FIRST ACTIVATION

**⚠ CAUTION:** to use this product it is necessary to use the dedicated "MyAlarm3 Cloud" APP downloadable via the QR Code on the cover or via the app store and apple store.

**First startup procedure:**

1. Download the iOS / Android APP (see QR Code on the cover or search for MyAlarm3 Cloud in the stores);
2. Download the installation manual from the APP or from the QR Code on the cover to get the complete guide;
3. Install the WiFi antenna supplied with the control unit (or external antenna: see the accessories section on the web page dedicated to the product) and check that the SD Card is correctly inserted;
4. Connect the supplied power supply to the device and power the control unit. If the MyAlarm3 Cloud W-AIR does not turn on, press and hold the PWR button for a few seconds;

- When you turn it on for the first time, the device is in "Access Point" mode. The yellow "NET" LED lights up with a continuous slow flash and the writing "WiFi Access Point" appears on the screen;
- Using your mobile phone, connect to the WiFi network "MYA\_XXXXXXXXXXXX" where the X represent the MAC ADDRESS of the device. Once connected to the control unit, open the address <http://192.168.1.4> on the web browser to access the WEB SERVER of the MyALARM3 Cloud W-AIR and enter the SSID and Password of the WiFi network to which you want to connect;
- Once the association procedure has been completed, proceed with the activation of the Seneca cloud account by following the procedure below.

**Simplified activation procedure (for complete procedure see the user manual):**

- Open the MyAlarm3 Cloud APP, register your Seneca cloud account (if you don't already have one) and wait for the account activation email;
- After receiving the account activation email, select the "ACTIVATE ACCOUNT" key;
- After activating the account, open the app again and log in for the first time entering the username and password you have just created;
- Enter the 5 + 10 character "activation code" on the back of the control unit and select the "ACTIVATE" button (if it is not the first service associated with the account, from the app click "change system" and then select the "ADD" button);
- From now on, the service is active and the control unit's owner account can access the MyAlarm3 Cloud W-AIR system from the MyAlarm3 Cloud mobile app, as well as invite other users to use its newly activated MyAlarm3 Cloud W-AIR.

**Switching on and menu keys:**

The MyAlarm3 Cloud W-AIR is fitted with an ON/OFF PWR key positioned in the LH top corner (Figure 2).

To switch it off, keep the PWR key pressed for a few seconds and then press again to confirm switching off.

The device is fitted with a SCR key, in the RH top corner. Pressing this key allows you to change the screen shown on the display.

**N.B.:** In order to guarantee the MyAlarm3 Cloud W-AIR control unit works correctly, **THE CONTENT OF THE SD CARD MUST NOT BE REMOVED.**

**IMPORTANT:** SENECA s.r.l. is not responsible for the times, methods or non-delivery of reports (alarms, data, etc.) provided by the system via push notification as these communications depend on the internet and/or telephone connectivity services on which SENECA s.r.l. has no possibility of intervening.

For any further information, consult the Cloud service supply contract.

